



ENTERPRISE ARCHITECT

User Guide Series

The Application Desktop

Author: Sparx Systems

Date: 16/10/2024

Version: 17.0

CREATED WITH  **ENTERPRISE
ARCHITECT**

Table of Contents

The Application Desktop	7
The Start Page	9
How to Remove Links to Recent Projects	13
The Ribbon Menu	15
File Management	17
Start Ribbon	19
All Windows Panel	21
Explore Panel	23
Appearance Panel	27
Collaborate Panel	29
Personal Panel	32
Help Panel	34
Design Ribbon	36
Package Panel	37
Diagram Panel	39
Element Panel	41
Dictionary Panel	44
Layout Ribbon	45
Diagram Panel	47
Style Panel	50
Alignment Panel	52
Tools Panel	54
Filter Panel	55
Helpers Panel	57
Auto Refresh Panel	59
Develop Ribbon	60
Data Modeling Panel	61
Schema Modeling Panel	62
Source Code Panel	63
Simulate Ribbon	66
Dynamic Simulation Panel	68
Executable States Panel	70
Decision Analysis Panel	71
Process Analysis Panel	72
System Behavior Panel	73
Console Panel	74
Run Simulation Panel	75
Execute Ribbon	76
All Windows Panel	77
Tools Panel	78
Windows Panel	82
Source Panel	83
Run Panel	85
Construct Ribbon	87
All Windows Panel	89
Resource Management Panel	90
Test Management Panel	93

Change Management Panel	95
Project Management Panel	99
Specialize Ribbon	101
Scripting Panel	103
Information Exchange Panel	104
Technologies Panel	106
Add-Ins Panel	107
Publish Ribbon	108
Model Reports Panel	109
Diagram Image Panel	111
Model Exchange Panel	112
Settings Ribbon	114
Security Panel	116
Model Panel	118
Reference Data Panel	120
Version Control Panel	122
User Tools Panel	123
Specification - Specify Ribbon	124
Element Panel	125
Display Panel	128
Document - Edit Ribbon	131
File Panel	132
Edit Panel	134
Font Panel	138
Paragraph Panel	140
Customizing Ribbon Sets	145
The Window Selectors	147
The Design Window Selector	148
The Properties Window Selector	152
The Collaborate Window Selector	156
The Execute Window Selector	159
The Construct Window Selector	163
The Publish Window Selector	167
The Workspace Window Selector	172
Navigating the Model	177
Exploring Your Model	179
The Navigator Toolbar	180
User Preferences	183
General Options	185
Window Behavior	187
Diagram Options	191
Diagram Theme Options	194
Diagram Gradients and Background	196
Standard Colors	199
Create Custom Colors	202
Get/Set Custom Project Colors	204
Diagram Appearance Options	206
Set User Default Fonts	209
Diagram Behavior Options	211
Sequence Diagram Options	215
Object Display Options	217

Connector Display Options	221
Communication Message Colors	224
XML Specifications	225
Customize the Desktop	228
Visual Styles	231
Docked Windows	234
Auto Hide Windows	239
Advanced Customization	242
Customize Dialog	243
Customize Commands	244
Customize Toolbars	247
Add Custom Tools	249
Open External Tools	250
Pass Parameters to Applications	252
Customize Keyboard Shortcuts	253
Customize Submenus	255
Customize Options	256
Workspace Layouts	257
The Browser Window	260
Browser - Header Bar	265
Browser - Context	268
Browser - Diagram	270
Browser - Resources	272
Hide and Show Browser Tabs	276
Model Packages	277
Refine Browser Content	278
Browser Window Context Menus	280
Model (Root Node) Menu - Browser Window	281
Package Menu - Browser Window	283
Properties Sub-Menu	285
Package Control Sub-Menu	286
Copy/Paste Sub-Menu	287
Contents Sub-Menu	289
Element Menu - Browser Window	290
Properties Sub-Menu	293
Add Sub Menu	295
Element Copy/Paste Submenu	297
Diagram Menu - Browser Window	299
Diagram Copy/Paste Menu	301
Operation/Attribute Menu - Browser Window	302
Browser Window Icon Overlays	304
Order Package Contents	306
Set Default Behavior	307
The Properties Window	308
Properties Window for Diagrams	311
Properties Window - Diagram	315
Properties Window for Elements	320
Properties Window - Element	323
Properties Window and Dialog for Connectors	327
Connector Advanced (Dialog)	331
Connector Tagged Values	333

Source and Target Role	335
Connector Constraints	338
Binding	340
Properties Window for Attributes	341
Create Properties	345
Attribute Constraints	347
Properties Window for Operations	348
User Button	351
The Notes Window	353
Notes Toolbar	359
Text Translation	360
The Focus Window	363
Model Views	364
The Recent Folder	367
Model Views Context Menus	371
Model Views Operations	374
Diagram Slide Show	377
Working Sets	380
Focus - Quick Find	384
Focus - Revisit	386
The Journal Tab	387
Save Journal to File	389
The Inspector Window	391
Inspector - Details	394
Inspector - Status	398
Tracing Relationships	400
Traceability Tools	401
The Traceability Window	403
Relationship Matrix	406
Set Element Type	409
Set Connector Type and Direction	410
Set Source and Target Package	411
Matrix Overlays	413
Create a Matrix Overlay	414
Apply an Overlay to a Cell	416
Matrix Profiles	418
Creating and Deleting Relationships	420
Relationship Matrix Options	422
Review Source and Target Elements	425
The Relationships Window	426
Example Traceability Diagram	430
Gap Analysis Matrix	432
Edit Gap Notes	435
The Search Window	436
Model Search	437
Pre-defined Searches	440
Create Search Definitions	452
Define & Modify Searches	457
Add Filters	460
Advanced Search Options	462
Customizing the Search View	464

Model Search Context Menu	466
The Summary Window	469
The Package Browser	471
List Header	474
Package Browser Options	476
The Portals Bar	480
Recent Places Portal	483
Workspaces Portal	484
Perspectives Portal	486
Windows Portal	487
Extend Portal	490
Execute Portal	491
Guidebook Portal	494
Learning Portal	495
The System Output Window	497
The Code Editors	499
Keyboard Shortcuts	500
Keyboard-Mouse Shortcuts	508
Diagram Shortcuts	510
Status Bar	514
Legacy Toolbars	516
Quick Access Toolbar	517
Default Tools Toolbar	520
Project Toolbar	522
Diagram Toolbar	524
Element Toolbar	526
Connector Toolbar	528
Code Engineering Toolbar	530
Simulate Toolbar	532
Build Toolbar	534
Record & Analyze Toolbar	536
Debug Toolbar	538
Collaborate Toolbar	540
Custom Draw Style Toolbar	542
Publish Toolbar	545

The Application Desktop

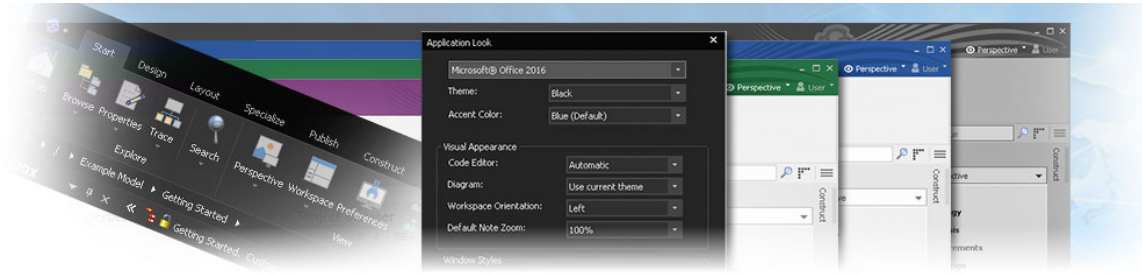

The Enterprise Architect application workspace (or user interface) provides a multi-featured and flexible analysis, modeling, design and construction environment. The workspace is built from familiar components, such as toolbars, docking windows, dialogs and menus. Together these elements provide a rich set of tools for working with models, UML, diagrams, source code, executing applications (debugging and visualization), rich text documents, collaborative tools, extension technologies and much more.

The Enterprise Architect user interface is highly customizable both in functionality and in appearance. Visual styles are available based on the popular Microsoft Office and Visual Studio, from the classic look and feel of the Windows XP era right up to the latest Office and Visual Studio incarnations. Dark and light styles are further enhanced with the ability to automatically display source code and diagrams in dark or normal styles.

Customization of toolbars, menus, workspace layouts, Perspectives and shortcuts helps you get the most out of Enterprise Architect for your particular needs. Taking the time to become familiar with the customizations available is well worth while, as it can help you build the precise modeling and design environment you need to focus on your work.

If you want to explore the basic process and tools for creating a model in Enterprise Architect, you can watch the demonstration on the Sparx Systems website, and/or work through the simple Tutorial provided in this section. Use the links under the 'Learn more' heading.

User Interface Tools

Tools	Description
Enterprise Architect Workspace	The Workspace is the interface through which you create, open and display your models. The main workspace component is the central Diagram View, which is where you create model diagrams, view reports, scroll through lists of model elements and edit and debug source code.
Ribbons	The ribbons provide access both to high-level functions related to the project life cycle, and to project and system administration functions; at all levels of the system you can also access functions and operations using context menus.
Windows	The windows help you to enter and display information on your project and models; you can re-arrange windows to adapt the screen space to your work habits.
Toolbars	Toolbars are small sets of buttons that provide quick access to common operations, both on your project as a whole and on the individual modeling units.
Diagram Toolbox	The Diagram Toolbox provides all the components and connectors that you use to create models using the medium of diagrams; the Toolbox automatically matches the kind of diagram you have open, from any technology that is currently active in your model.
Keyboard Keys	You can use keyboard key combinations to quickly initiate a wide range of actions

	throughout the system, and Diagram Quick Key (single-key) shortcuts to perform actions on the elements and connectors in an open diagram.
Customization	Enterprise Architect provides various customization tools that you can use to: <ul style="list-style-type: none">• Tailor the ribbons, menus, toolbars and function keys you use in your work• Set the visual style of the application, and• Customize the workspace layout
Navigation	You can use several navigation and search tools to search for, track and locate information in your project, and filter the information so that you can explore particular views of your project rather than the entire contents.

The Start Page

The Start Page is the default landing page that displays when you first open Enterprise Architect. It provides a range of useful tools to:

- Create and/or access project files, connect to a server repository, or access a project via the Cloud, through the 'Open' options, the 'Recent' and 'Pinned' lists and the 'Manage Projects' option; these are documented in this Help topic
- Generate basic models in your project using Patterns from a wide range of technologies, both when you first create the project and over time; you can develop these models further as complete components of your project - see the *Model Builder* Help topic
- Add diagrams to your model based on diagram patterns tailored to specific technologies, displaying the appropriate Toolbox pages for the generated diagram; see the *Add New Diagrams* Help topic
- Quickly set up the organization of any number of complex processes that require common, structured methods and carefully organized checkpoints at important stages based on a range of Process Guidance templates; see the *Applying Process Guidance* Help topic

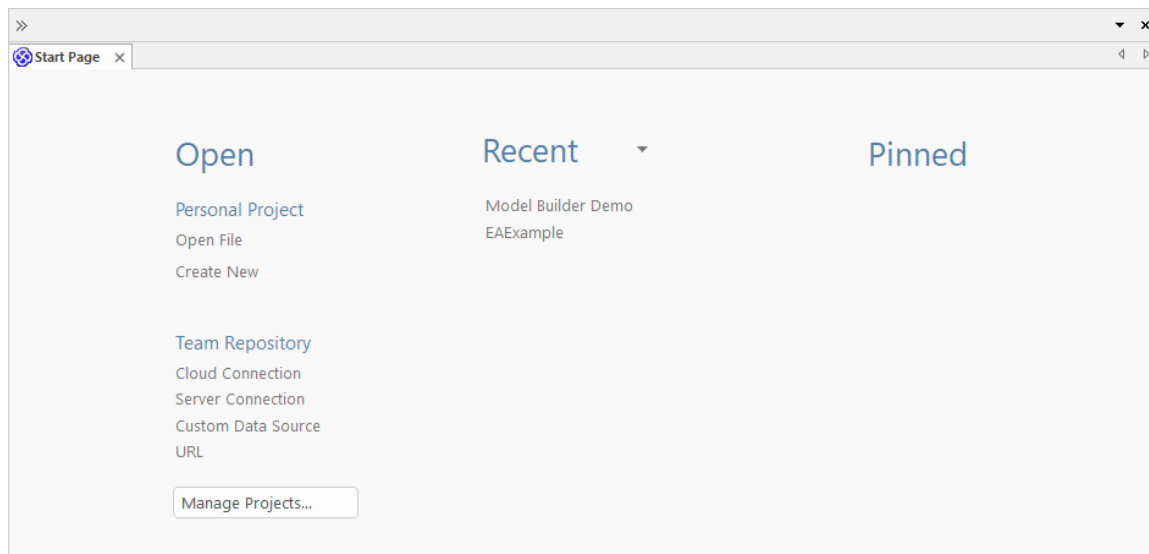

Access

Opened by default on start up of Enterprise Architect, at the 'Open Project' tab.

Ribbon	Start > Appearance > View > Show Start Page > Open Project
Other	(If the Start Page is not shown) Click on the drop-down arrow at the right of the 'current view' bar (above the view name tabs) and select the 'Show Start Page' option > Open Project

Open

Option	Action
Open File	Click on this option to display the Windows 'Select Enterprise Architect Project to

	Open' dialog, to browse for and open an existing .eap, .eapx, .qea, .qeax or .feap project file.
Create New	Click on this option to display the Windows 'New Project' dialog , to create a new local .eap, .eapx, .qea, .qeap or .feap project file, that you can add model structures to using the Model Builder.
Cloud Connection	Click on this option to open the 'Cloud Connection' dialog, which you use to specify a project held at a remote location, and to access it through the internet or web. You work on the project using the Enterprise Architect installation on your machine. An advantage of working in this way is that you do not need to have the database drivers installed on your machine, as you would to work on projects held on a DBMS server.
Server Connection	Click on this option to display the 'Open Server Connection' dialog, on which you specify an existing data source to connect to, on one of a number of supported repositories. This feature is available in the Corporate, Unified and Ultimate Editions.
Custom Data Source	Click on this option to display the Microsoft 'Data Link Properties' dialog, from which you begin to define a data source to connect to, on one of a number of supported repositories. This feature is available in the Corporate, Unified and Ultimate Editions.
URL	If you click on this option, the 'Connection String' dialog displays. Type or paste in the server connection string to the project you want to open, and click on the OK button. This is the same dialog that you use in the 'Manage Projects' dialog (see the 'Manage Projects' option in the next section.)

Manage Projects

Click on this option to open the 'Manage Projects' dialog, which you use to manage connections to the Enterprise Architect projects (.eap files, .eapx files, .qea files, .qeax files, .feap files, DBMS server connections and Cloud connections) to which you have access. See the *Managing Connections to Projects* Help topic.

Recent

This is a list of up to ten Enterprise Architect projects (.qea files, .qeax files, .feap files, DBMS server connections and Cloud connections) that you have opened most recently. The drop-down arrow in the list heading displays options to:

- Switch the list between recently-accessed models and currently 'watched' models
- Change the sequence of models in the list between an alphabetical listing and a chronological listing (most recently opened at the top)
- Set up a 'Watched Model' configuration to define what projects to monitor and what actions to capture within the models (see the *Model Watches* Help topic)

Option	Action

<Model names>	<p>Either:</p> <ul style="list-style-type: none"> • Click on a project name in the list to open that project in the <i>current instance</i> of Enterprise Architect (and close any project you already have open), or • Ctrl+click on a project name in the list to launch that project in a <i>separate instance</i> of Enterprise Architect, in addition to the current project <p>You can also right-click on a project name in the list and display a short context menu with options to:</p> <ul style="list-style-type: none"> • Open the selected project in the current instance of Enterprise Architect (and close any project you already have open) • Launch the selected project in a new instance of Enterprise Architect (keeping the current project open in the current instance) • Add the project to the list of watched projects that you are monitoring for various kinds of activity • Pin the connection, thereby moving it to the 'Pinned' model list; the project name is deleted from the 'Recent' list • Edit the name of the selected project, by overtyping the name in a brief dialog • Remove the selected project from the list (which removes the link to the project, not the project file itself)
---------------	---

Pinned

The 'Pinned' repository list allows modelers who frequently work on particular repositories to add them to a list where they can always be easily and reliably accessed. Some users might only work on a single corporate repository or a small set of project repositories, so the 'Recent' list will always provide access to these projects. However, other users such as consultants and multi-disciplinary team members often work on a large number of repositories and, in this scenario, the repositories they need to visit regularly might 'drop-off' the 'Recent' list as new repositories are visited. If these repositories are added to the 'Pinned' list they will always be available for selection.

The 'Pinned' list shows up to ten Enterprise Architect projects (.qea files, .qeax files, .feap files, DBMS server connections and Cloud connections) that you have opened at some point in the 'Recent' list and you have 'pinned' so that they remain available for selection across all registry hives that you might use.

You can also right-click on a project name in the list and display a short context menu with options to:

- Open the selected project in the current instance of Enterprise Architect (and close any project you already have open)
- Launch the selected project in a new instance of Enterprise Architect (keeping the current project open in the current instance)
- If the project is accessed via a connection string to a DBMS or Cloud repository, change the connection string
- Edit the name of the selected project, by overtyping the name in a brief dialog
- Remove the selected project from the list (which removes the link to the project, not the project file itself; the link is not returned to the 'Recent' list)

Notes

- When you initially open Enterprise Architect, the Browser window contains the option '<click to open project>'; this has the same effect as the Manage Projects button
- You can hide the Start Page, or show it again, by toggling the 'Start > Appearance > View > Show Start Page' ribbon option; this setting persists after shut down and restart of Enterprise Architect until you explicitly toggle the option again

How to Remove Links to Recent Projects

In the 'Manage Projects' dialog and on the Start Page 'Recent' section, the projects that you have opened most recently are listed either in alphabetical order or in the order of opening date/time (most recent first), up to a maximum of ten projects. If the list identifies projects that you do not want to be so immediately accessible, you can remove them specifically from the list.

Removing a project from the 'Recent' list only removes the hyperlink to the project and does not remove the project from the file system or repository.

Access

Ribbon	 > Open Project or Start > Appearance > View > Show Start Page > Recent
Keyboard Shortcuts	Ctrl+O

Remove a Project Hyperlink from the 'Manage Projects' List

Step	Action
1	On the 'Manage Projects' dialog, in the 'Recent Projects' panel, click on the name of the project to be removed.
2	Click on the Remove Selection from List button. The project link is immediately removed from the list.

Remove a Project Hyperlink from the Start Page, Recent List

Step	Action
1	On the Start Page, right-click on the name of the project to remove and select the 'Remove Selection from List' option.
2	The name of the project disappears from the list.

Notes

- You can only remove one project link from the list at a time
- To remove a link there must be at least two projects between the 'Recent' and 'Pinned' lists

The Ribbon Menu

Enterprise Architect displays a set of ribbons at the top of the screen, as a modern, contemporary way of accessing the tool's features. Ribbons bring many features immediately to the surface, making them easily accessible to a modeler; both new users and those who have been using Enterprise Architect for many years will be delighted to find their preferred tools right at their fingertips. Each ribbon provides actions with a particular focus, and the commands on the ribbons are grouped by function into panels.

Searching for an Item

The ribbons expose a wide range of Enterprise Architect features, and the system provides two facilities to help you locate and access the feature you need:

- In the 'Microsoft Office 2016' Visual Style theme, click on the 'Find Command' field at the end of the sequence of tabs and type in some text relating to the feature you want to locate, then press the Enter key; this displays a hierarchical menu of options that match your search text, and when you click on an option the appropriate dialog opens
- Click on the  button (for File Management options) to the left of the ribbon tabs and type your search text in the 'Search' field at the bottom of the resulting dialog; a list of options relating to the search text is immediately displayed down the left hand side of the dialog and, when you click on an option, the appropriate dialog opens

Also, when you 'mouse over' any option on any of the ribbons, a tool-tip displays, summarizing the function of the option. The tool-tip can be configured to display either in the left end of the status bar at the bottom of the screen or floating beside the option it describes.

You therefore have help in identifying both what option provides a function, and what function an option provides.

Contextual Ribbons

Some ribbons are contextual and are only needed when you are performing a particular task. For example, the 'Document-Edit' ribbon is only needed when you are viewing or editing a document inside Enterprise Architect. This ribbon will remain visible while a document is open; when all documents are closed the ribbon will be hidden from view.

Moving Between Ribbons

To change the selection of a ribbon, you can either left-click on the tab of the ribbon you require, or hover the cursor on the ribbon band and roll the mouse scroll-wheel forward to scroll right to left through the ribbon tabs or backwards to scroll left to right.

Using the Keyboard with Ribbons

The actions that are presented on the ribbons can also be accessed using the keyboard. If you tap and release the Alt key, each ribbon will be annotated with a letter code. Pressing this letter on the keyboard will activate the ribbon and display a further set of annotations for the actions in the ribbon.

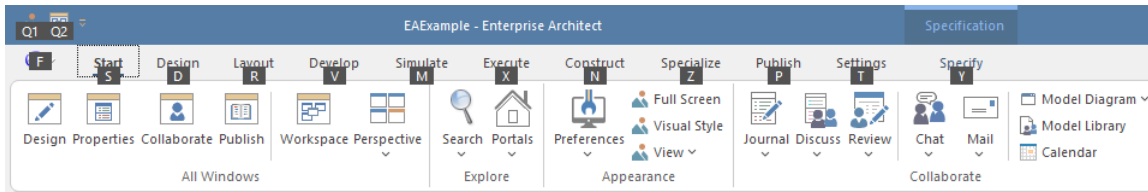

Customizing the Ribbons

If a ribbon presents more options than you require, you can customize it to hide the panel containing those options, or hide the whole ribbon. To do this, you select the 'My Ribbon Sets' tab on the 'Workspace Layout' dialog (Start > All Windows > Workspace > Workspace Tools > My Ribbon Sets), create a Ribbon Set to customize the ribbon display, and define the ribbons and panels to show or hide in that Ribbon Set. You can re-activate hidden ribbons and panels by editing this Ribbon Set.

The 'My Ribbon Sets' tab also provides the option of defining one of the ribbons as the default to automatically display when Enterprise Architect is opened in a work session. Normally the 'Start' ribbon is fully open when the system is accessed. For more information, see the *Customizing Ribbon Sets* Help topic.

Minimizing the Ribbon Bar

On occasion you might need more screen space to view diagrams and other model representations. To help with this, you can conveniently minimize the ribbons and completely hide them from view. The ribbon **tabs** will still be visible, so you can click on the required tab and redisplay the corresponding ribbon until the focus is returned to another part of the user interface. Many modelers will find that leaving the ribbons maximized will provide a convenient visual reminder of the actions that are available while working on models.

To minimize or restore the ribbons, right-click on the ribbon bar and select or deselect the 'Minimize the Ribbon' option. Alternatively, double-click on the name tab of the currently-displayed ribbon.

Hiding Ribbon Text

At times you might find that the ribbon text adds more visual distraction than you would like. You can select another option on the ribbon context menu to hide the text underneath the larger ribbon icons so that it only displays when you mouse-over the icon. You can then remind yourself of the icon's purpose or select the drop-down options from the icon menu without the text being displayed there permanently.

Right-click on the ribbon background and select the 'Minimal Text Mode' option. Click on the option again to deselect it and redisplay the icon text.

File Management

When managing the project as a unit, you can create, open, close or save projects, provide desktop shortcuts to a project, or perform print tasks.

Access

Other	Click on 
-------	--

File Management Options

Option	Action
New Project	Create a new Enterprise Architect project. Shortcut: Ctrl+N
Open Project	Open an existing project, or create a new project from scratch or from a base template project, using the 'Manage Projects' dialog Shortcut: Ctrl+O
Reload Project	Reload the current project. (Use this in a multi-user environment to refresh the Browser window). Shortcut: Ctrl+Shift+F11
Close Project	Close the current project.
Save as Shortcut	Create a desktop shortcut to the current project. (This option is also active in the 'Lite', read-only edition of Enterprise Architect.)
Print Setup	Configure your printer's settings.
Page Setup	Configure the page settings to print the current diagram.
Print Preview	Preview how the currently displayed diagram will print.
Print	Print the currently displayed diagram. You can also make use of other facilities to change the scale of the printed diagram (the number of pages it takes up) and to print or omit page headers and footers on the diagram. By de-selecting the 'Printable' option on an element on a diagram, you can omit that element and its connectors from the printed diagram. Shortcut: Ctrl+P
Print to PDF	Save the currently displayed diagram as a PDF file. A browser displays to select the PDF file name and directory path. By de-selecting the 'Printable' option on an element on a diagram, you can omit that

	element and its connectors from the diagram in the PDF output.
Recent Models	Select from a list of up to ten of the most recently opened projects, to re-open the selected project.
Pinned Models	Select from a list of up to ten of your pinned projects, to re-open the selected project.
Search	Type the name of an operation or command that you want to locate; a list of options relating to the search text is immediately displayed down the left hand side of the dialog and, when you click on an option, the appropriate dialog opens.
Exit	Exit from Enterprise Architect.

Start Ribbon

The 'Start' ribbon provides a range of facilities for exploring, navigating and viewing the information in the repository. These include tools to navigate to items, to view the important events, messages, discussions and work that is relevant to a modeler on a given day, and to view and change your workspace settings, including styles and preferences. This ribbon also provides access to the Help facilities, including registering licence keys and checking for updates.

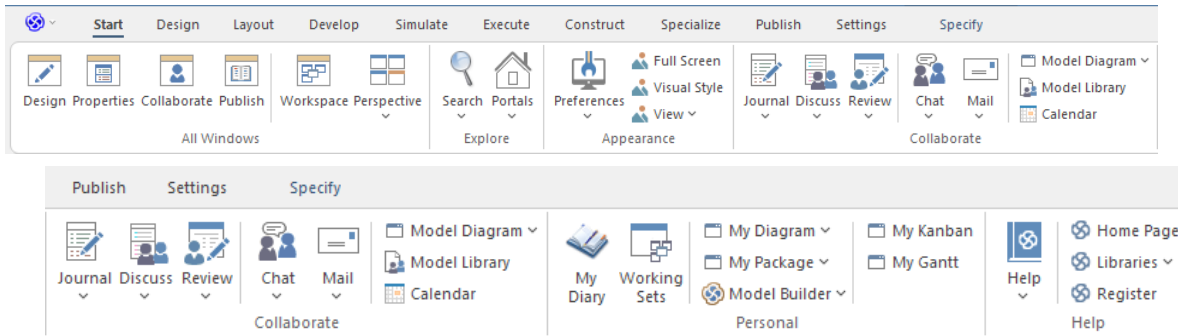

Panels

Panel	Description
All Windows	You can use the 'All Windows' panel to access a range of Window Selectors to select and open a window or a workspace. You can define any number of workspace layouts and working sets, saving combinations and arrangements of windows that are specific to a role that ultimately increases your productivity as a modeler.
Explore	The 'Explore' panel provides access to a range of search facilities and to the Portals feature.
Appearance	You can also define the look and feel of the application, setting preferences that change the style of the interface to suit the work role you are performing. There is a wide range of preferences you can set to tailor the way the application behaves under your login, including setting colors, fonts and diagram styles.
Collaborate	Enterprise Architect is a collaboration platform and allows any number of people to work on models and diagrams at the same time, in a cooperative and team effort. The collaboration tools include Reviews and Discussions of elements, the Model Library, Model Mail - which contains messages from other modelers - the Project Calendar listing important events, the 'Journal' informal comment capture facility. The tools ensure that communication about the elements, diagrams, lists and matrices are available in the model and links can be created back to these items from the collaboration tools. The 'Collaborate' panel conveniently brings these tools together, ensuring that you are informed about what you need to attend to and made aware of information that is important to your role.
Personal	The 'Personal' panel gives access to a great facility for maintaining a daily diary, in which you can note down reminders of what you have done or intend to do within the model. It provides an option for opening the 'Working Sets' tab of the Focus window, to set up and maintain groups of windows, diagrams and views to return to as a set in later work sessions. On the right hand side it has a set of options for displaying and managing your user default diagram and your default work Package, and for displaying the Gantt Chart listing your work allocations and the Kanban

	diagram you have set as your personal default.
Help	<p>The 'Help' panel provides access to the Help system and to a wide range of on-line facilities to support your use of the tool, including the management of License Keys through the 'Register' option. The Help system contains both overviews of functional areas of the application and detailed topics on how to use specific tools, helping you to be highly productive. The Help is normally accessed as an on-line, web-based system, but you can select to download the file-based Help to provide a local Help system. You can also open the Learning Center library, which provides user-focused guidance for common tasks.</p>

All Windows Panel

You can use the 'All Windows' panel to access a range of Window Selectors to select and open a window or a workspace. The panel also helps you to define any number of workspace layouts and working sets, saving sets and arrangements of windows that are specific to a role that ultimately increases your productivity as a modeler. The 'Perspective' drop-down helps you to select and set the global Perspective for your model.

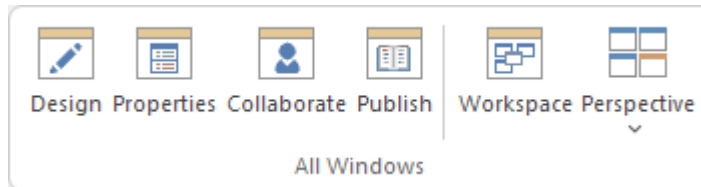

Available Facilities

Facility	Description
Design	Click on this icon to display the Design Window Selector, which provides access to the windows for locating, creating and working on objects on the model, including within diagrams. Click on the name of the required window to immediately open it.
Properties	Click on this icon to display the Properties Window Selector, which lists the windows for editing the properties, features, structural elements and internal structures of an element. Click on the name of the required window or tab to immediately open it. This window can be displayed from both the 'Start > All Windows' panel and the 'Design > Element' panel.
Collaborate	Click on this icon to display the Collaborate Window Selector, which provides access to the Collaboration facilities such as Discussions, Reviews, Journal entries, personal conversations and information concerning the overall model.
Publish	Click on this icon to display the Publish Window Selector, which provides access to facilities for generating static and dynamic reports, exchanging models in part or entire, and keeping the model data accurate and up to date.
Workspace	Click on this icon to display the Workspace window, from which you can select from lists of system-defined and user-defined ('User Layouts') workspaces. Each workspace opens a number of related windows that together support a particular task or area of work in Enterprise Architect.
Perspective	<p>Click on this icon to display a list of options to select and set the global Perspective for your model.</p> <p>The list is headed by the option to set 'All' Perspectives, followed by options for Perspectives defined for the model, Perspectives you have defined for your personal use, and Perspectives (in the 'Specialized' group) provided by MDG Technologies.</p> <p>In the next block of options are the names of the standard, system-defined Perspective groups, which expand to list the Perspective Sets.</p> <p>The last item in the list is the Settings option, which you select to display the 'Perspective Sets' dialog. You use this dialog to define the Personal and Model-based Perspective Sets, and to set up the Security Group-linked Perspectives.</p>

Explore Panel

The 'Explore' panel contains icons to invoke the Portals feature and a range of search facilities.

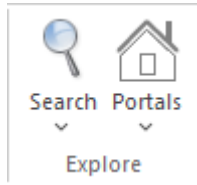

The Search Facilities

Click on the drop-down arrow under the icon to display a selection of search facilities that you can use to locate objects in the model, or code in source files:

- Model - display the Find in Project view, which provides access to the full range of standard and customized searches in your project (Ctrl+Alt+A)
- Files - locate and open source files having specific characteristics, using the 'Find in Files' dialog (Ctrl+Shift+Alt+F)
- Recent Diagrams - display the 'Find in Project' view defaulted to an executed specific search for recently modified (that is, Active) diagrams. The default time period is the three days prior to today's date
- Recent Elements - display the 'Find in Project' view defaulted to an executed specific search for recently modified (that is, Active) elements. The default time period is the three days prior to today's date
- Recent Tasks - display the 'Find in Project' view defaulted to an executed specific search for Active Tasks (those that are in progress)
- Diagram - display the Find in Project view, pre-loaded with the Diagram Details search to locate diagrams of a specific name or type
- Package - display the Find in Project view, pre-loaded with the Find Package search to locate Packages of a specific name or type
- Browse for Diagram - locate and select a specific diagram using the 'Select Classifier' dialog, which shows the full hierarchy of Packages in the model (Ctrl+Shift+Alt+D)
- Browse for Package - locate and select a specific Package using the 'Find Package' dialog, which shows the full hierarchy of Packages in the model (Ctrl+Shift+Alt+P)

The Portals

Clicking on the Portals icon displays a list of the Portals that you might use to set up the user interface to support a particular area of work. When you click on a Portal name the corresponding Portal displays on the left or right of the work area (according to your personal settings). The icon next to the name of the selected Portal is highlighted, so the list indicates which Portal is active.

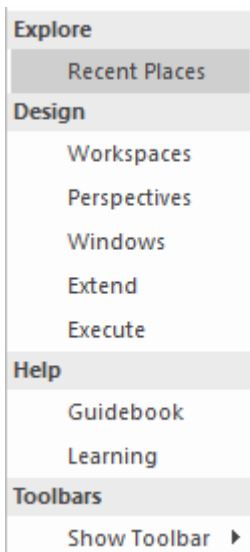

Portal/Option	Description
Workspaces	<p>Provides links to the system-provided workspaces that you might use to lay out the Enterprise Architect work area, and to any workspaces that you have created yourself. The categories provided are:</p> <ul style="list-style-type: none"> • My Workspaces • Core • Design • Software • Simulation • Construction • BABOK Guide
Recent Places	<p>Provides links to recently viewed diagrams, documents and files. Links are grouped into these categories:</p> <ul style="list-style-type: none"> • Current Diagrams • Recent Diagrams • Documents • Recent Files
Perspectives	<p>Provides a range of model Patterns from which you can generate model structures for particular areas of work. The Patterns are organized into groups within Perspectives, and presented for selection through the Model Builder dialog. The system-provided Perspectives are:</p> <ul style="list-style-type: none"> • UML • Strategy • Analysis • Requirements • UX Design • Business Modeling • Software Engineering • Systems Engineering • Database Engineering

	<ul style="list-style-type: none"> • Enterprise Architecture • Information Exchange • Publishing • Construction • Management
Windows	<p>Provides links to the Enterprise Architect windows and displays that you use to develop a model and create and manage the objects within it. These facilities are grouped under the activity areas of:</p> <ul style="list-style-type: none"> • Exploring the model • Displaying object properties • Managing the display of diagrams • Working with specialized tools • Tracing relationships between objects • Enabling collaboration between team members • Managing tests • Managing resource tasks • Project management and maintenance • Developing code and document templates
Extend	<p>Lists the MDG Technologies currently active in your model - such as ArcGIS and NIEM (4.0) - and for each one provides links to the facilities for working with those technologies within Enterprise Architect.</p>
Execute	<p>Provides a wide range of options that help you to:</p> <ul style="list-style-type: none"> • Perform Execution Analysis on your model - building and running the Analyzer scripts • Open the Record & Analyze, Profiler, Debugger and/or Testpoints dialogs for monitoring the execution of your modeled application • Set up and perform simulations of the execution of your application • Control the progress of a simulation • Access various windows that display specific aspects of debugging an application • Control the progress of a debug • Set up and run recording of the execution of an application • Display the dialogs to prepare to profile the execution of an application • Create and edit code from the model
Guidebook	<p>Provides links to the library of Enterprise Architect User Guides in PDF format. The Portal initially displays with ten categories of document, each of which can be expanded to a list of the PDF documents in that category.</p>
Learning	<p>Provides links to either the web version of the <i>Enterprise Architect User Guide</i>, or the locally-installed Help if you have downloaded that. The Portal also provides links to a number of useful web pages on the Sparx Systems website, such as the Resources, Tutorials, Webinars and Video Demos pages.</p>
Show Toolbar	<p>Not actually a Portal but a list of the 'floating' Toolbars that you can also anchor to the Toolbar ribbon above the work area. Toolbars that are currently active are marked with a tick. Click on the unmarked name of a hidden Toolbar to expose it</p>

	either floating or anchored, and click on a ticked Toolbar name to hide that Toolbar.
--	---

Appearance Panel

The 'Appearance panel helps you to define the look and feel of Enterprise Architect, setting preferences that change the style of the interface to suit the work role you are performing. There is a wide range of preferences you can set to tailor the way the application behaves under your login, including setting colors, fonts and diagram styles. You can also select options to display the interface in full-screen mode and in one of several visual styles, and you can temporarily hide or display selected sections of the interface.

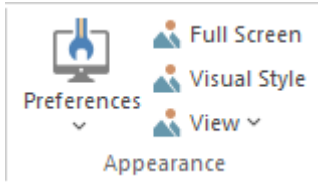

Available Facilities

Facility	Description
Preferences	<p>Click on the drop-down arrow to display options for:</p> <ul style="list-style-type: none"> Opening the 'Preferences' dialog on which you can set the general options of Enterprise Architect; you can control how the system behaves when you open a project, including setting the home directories and web pages the project refers to and how the Browser window responds when items are selected in it Displaying the Diagram Toolbar at the top of every diagram you open in the model Making toolbar icons larger and more visible both in the Toolbar ribbon and at the top of each dockable window, with immediate effect Opening the 'Toolbars' tab of the 'Customize' dialog to set which Toolbars to automatically display in the Toolbar ribbon Opening the 'Customization' dialog ('Other Options') to tailor other user controls, such as additional key combinations for accessing Enterprise Architect dialogs and facilities, and external tools to link to from within Enterprise Architect
Full Screen	Click on this icon to toggle Enterprise Architect in and out of 'Full Screen' mode.
Visual Style	Displays the 'Application Look' dialog, on which you can select from a range of visual styles, themes and accent colors. You can also choose options such as displaying window tabs at the top or bottom of the windows and displaying element properties using tree or list style displays.
View	<p>When you click on the drop-down arrow, this icon displays a menu of four options for managing what segments of the screen are displayed and how they are displayed.</p> <p>The 'Manage Views' option has these sub-options:</p> <ul style="list-style-type: none"> Float View - display the current View as a floating window, allowing it to be displayed in 'Full Screen' mode or to be moved to a different display monitor Focus View - set the input focus back to the View that last had focus (intended to be accessed via the command shortcut keys Ctrl+Shift+0) Reload View - load the latest information from the model database, to update the display of the current View

- Close View - lose the current View; you will be prompted to save any unsaved modifications
- Close All Except Current - close all Views except the current view; you will be prompted to save any unsaved modifications
- Close All - close all Views; you will be prompted to save any unsaved modifications
- Save All Modified Views - for every View that is currently open, save to the model database any modifications to the appearance of the View; these include modifications such as changes to color, size or position
- Auto Hide Active Window - auto hide the currently active window
- Auto Hide All Docked Windows - auto hide all open and docked windows
- Close Active Window - close the currently active window

The 'Show Start Page' option simply shows or hides the Start Page; this setting persists through shut down and restart, until you specifically change the option.

The 'Show All Ribbons' option refreshes the display of ribbons to show all of them, revealing any hidden by using a Custom Ribbon Set.

The 'Always on Top' option forces the main Enterprise Architect window to be on top of all other windows.

Collaborate Panel

Enterprise Architect is a convenient collaboration platform that allows any number of people to work on models and diagrams at the same time, in a cooperative and team effort. The collaboration tools include Reviews and Discussions of elements, the Model Library, Model Mail - which contains messages from other modelers - the Project Calendar listing important events, the 'Journal' informal comment capture facility, Gantt Charts listing work allocations and Kanban diagrams where tasks are presented. The tools ensure that communication about the elements, diagrams, lists and matrices are available in the model and links can be created back to these items from the collaboration tools. The 'Collaborate' panel conveniently brings these tools together, ensuring that you are informed about what you need to attend to and made aware of information that is important to your role.

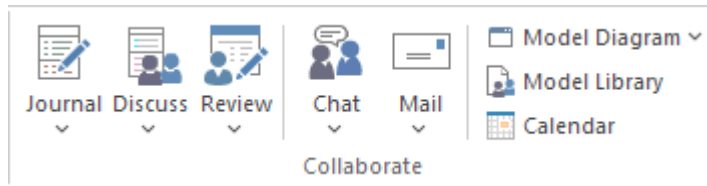

Available Facilities

Facility	Description
Journal	<p>Displays either the Discuss & Review window at the 'Journal' tab (main icon) or a short menu (drop-down arrow) providing these options:</p> <ul style="list-style-type: none"> Journal - opens the Discuss & Review window at the 'Journal' tab, which providing a great facility for maintaining a daily log of reminders of what the developers concerned with a selected element or diagram have done or intend to do for the selected object Journal History - opens the Discuss & Review History window at the Journal tab, on which you can review the journal entries for elements, grouped for Today, Yesterday, This Week, Last Week, This Month and Last Month Help - displays the <i>Journal</i> Help topic
Discuss	<p>Displays either the Discuss & Review window (main icon), on which you can manage current discussions of elements and diagrams, or a menu (drop-down arrow) providing these options:</p> <ul style="list-style-type: none"> Discuss - to display the Discuss & Review window at the 'Discuss' tab, on which you can create a new discussion or add to an existing discussion on a specific element or diagram Discussion History - to display the Discuss & Review - History window at the 'Discussions' tab, on which you can review the separate discussions of elements recorded in the model, grouped for Today, Yesterday, This Week, Last Week, This Month and Last Month Recently Discussed - to run a report that presents elements that have been the subject of discussion in the last 7 days (you can change the number of days in the 'Search Term' field) Help - to display the <i>Discussions</i> Help topic
Review	<p>Displays either the Discuss & Review window (main icon), on which you can set up and manage reviews of elements or diagrams, or a menu (drop-down arrow) providing these options:</p> <ul style="list-style-type: none"> Review - to display the Discuss & Review window at the 'Review' tab, on which you can join a review and create new discussion points or responses

	<p>within that review, on any element or diagram</p> <ul style="list-style-type: none"> • Review History - to display the Discuss & Review - History window at the 'Reviews' tab, showing the elements included in a selected review; you can switch to the 'Review' tab of the Discuss & Review window to show the details of a selected element under review • Manage Reviews - to display the Reviews view, listing all current and recent reviews of elements • Help - to display the <i>Reviews</i> Help topic
Chat	<p>Displays either the Chat & Mail window (main icon), on which you can start or continue Chats, or a menu (drop-down arrow) providing these options:</p> <ul style="list-style-type: none"> • Chat - to display the Chat & Mail window at the 'Chat' tab, on which you can follow and participate in quick conversations on a point of interest, with a selected user or members of a selected user group • Chat History - to display the Discuss & Review History window at the 'Chat' tab, on which you can review the separate Chats recorded in the model, grouped for Today, This Month, Last Month and Older • Recent Chats - to run a report that presents Chats that have been recorded in the last 3 days (you can change the number of days in the 'Search Term' field to cover a longer period) • Help - to display the <i>Model Chat</i> Help topic
Mail	<p>Click on this icon to display the 'Mail' tab of the Chat & Mail window, which provides access to the Model Mail facility. This enables you to send, receive and respond to emails within the project team, under your User Security ID, either as an individual user or as a member of a group that has a shared mail inbox.</p> <p>If you click on the drop-down arrow, you can select from options to:</p> <ul style="list-style-type: none"> • Open the 'Sent Messages' tab of the main work area, listing all emails sent by you or by other members of the security groups of which you are a member • Open the 'Model Message' dialog, in which you create and send an email message to one or more team members • (Having selected a model object first) Open the 'Model Message' dialog that already contains a hyperlink to the selected object
Model Diagram	<p>Click on this icon to open the diagram that has been defined as the default model diagram for all users of the model.</p> <p>Click on the drop-arrow beside this icon to presents two options:</p> <ul style="list-style-type: none"> • Open Model Diagram - which opens the diagram that has been defined as the default model diagram for all users of the model • Manage - provides sub-options to set the currently-open diagram as the model default, search for and select another diagram as the model default, or clear the current default selection; you have to have the proper authorization to set the model default diagram
Model Library	<p>Click on this icon to open the Model Library, which you use to review and add to a hierarchically-structured repository of comments, reports, reviews and documents on any structure, feature or aspect of the project or of other, related projects.</p>
Calendar	<p>Displays the Project Calendar, defaulted to today's date, on which you can check for scheduled meetings and reminders of events, and add items for today or any day in the future.</p>

Personal Panel

The 'Personal' panel provides options to maintain work area settings that are specific to your login, such as your daily diary, your working sets - groups of windows, diagrams and views to return to as a set in later work sessions - your user default diagram, your default work Package, your Gantt Chart listing your work allocations, and the Kanban diagram you have set as your personal default.

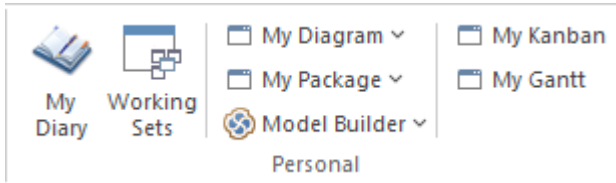

Available Facilities

Facility	
My Diary	Click on this icon to open the 'My Diary' tab of the Chat & Mail window, through which you can maintain a daily diary containing ideas, comments, notes, suggestions, events, to-do lists and other reminders of what you have done or intend to do within the model. The facility is simple to use, allowing you to quickly jot down your thoughts as they occur to you.
Working Sets	Click on the Working Sets icon to open the 'Working Sets' tab of the Focus window, on which you can examine, edit, select, create and delete collections of windows and diagrams to open in your work area.
My Diagram	Click on this icon to open the diagram that has been set as your user default diagram. Click on the drop-arrow beside this icon to display options to open your user default diagram, or to set the currently open diagram as your user default, locate and select another diagram as the user default, or clear the currently-specified user default diagram.
My Package	Click on this icon to open in the Browser window, the Package set as your user default Package. Click on the drop-arrow beside this icon to display options to locate and open your default Package, or to locate and select a Package as the default to open in the Browser window when you log in to Enterprise Architect.
Model Builder	Click on this icon to display the Model Builder window, which allows you select and import a model pattern as a starting point for your project. It offers a large variety of patterns across a wide range of modeling domains. Click on the drop-down arrow to display the Builder Page Options menu.
My Kanban	Displays the Kanban diagram that you have set as your personal default.
My Gantt	Displays a Gantt chart listing the tasks that have been allocated to you and that are not yet complete.

Notes

- The 'Set Current as Default' and 'Choose Default' options are available in the Corporate, Unified and Ultimate Editions of Enterprise Architect; User Security must be enabled
- The User Default diagram overrides the Model Default diagram; the User Default setting is itself overridden by a project shortcut, which defines displays to present on opening the project

Help Panel

The 'Help' panel provides access to the extensive Help system and to a wide range of on-line facilities to support your use of the tool, including the management of License Keys. The Help system contains both overviews of functional areas of the application and detailed topics on how to use specific tools, helping you to be highly productive. The Help is normally accessed as an on-line, web-based system, but you can select to download a file-based version of the Help to provide a local Help system. You can also open the Learning Center, which provides user-focused guidance for common tasks, especially those specific to your own use of the system that you have documented yourself.

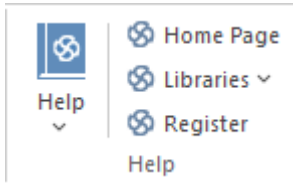

Available Facilities

Facility	Description
Help	<p>The Help icon displays a menu containing a wealth of options for opening and exploring the Help, obtaining information from a number of other sources, and requesting support from Sparx Systems.</p> <ul style="list-style-type: none"> • Open Help - opens the Help as a set of pages in HTML format, either on the web or local to your system, beginning with the <i>Introduction to Enterprise Architect</i> topic • Search Help - opens the 'Find in Files' search facility, which you use to specify and search for a text string in the Help • Go toTopic - opens a specific Help topic that you identify by name, if you already know the topic you want to display • Explore Online Resources - opens a submenu of options for accessing resources on the Sparx Systems web site: <ul style="list-style-type: none"> - Install Help Locally - displays a prompt to download the 'EA UserGuide' installer file (EAUserGuide.msi), which you use to install the Help files locally - User Forum and News - opens the Sparx Systems User Forum, which you can read as a guest or as a logged-in user - Request a Feature - opens the standard form for submitting a request for a feature you would like to see in Enterprise Architect - Bug Report Page - opens the standard form for reporting the details of a bug you have found in Enterprise Architect (also prompts you for your registered user ID and password) - Automation Interface - opens the Sparx Systems web page on the Automation Interface, providing a number of examples of its use - Introducing UML - accesses the Sparx Systems online UML tutorials - Pricing and Purchase Options - displays details on purchasing or upgrading Enterprise Architect over the internet • Open Keyboard Accelerator Map - displays the 'Help Keyboard' dialog, which identifies which keyboard keys have been mapped to Enterprise Architect commands; you can customize these mappings if necessary • Open the Example Model - opens the EAExample model within the current instance of Enterprise Architect • Configure On-line Help Translate - displays a short dialog in which you specify the language into which you want to translate the online Help when

	<p>you display a page; the requested page is passed to the Google Translate site and displayed in the specified language (this option does not operate on the downloaded local Help)</p> <ul style="list-style-type: none"> • Register and Manage Your License Key(s) - configure and manage the license keys used to register Enterprise Architect and its Add-Ins • Check for Updates - displays the Sparx Systems web page on the latest build and its release notes • View the License Agreement - displays the Enterprise Architect End User License Agreement • Ordering Information - displays information on how to purchase Enterprise Architect • Pro Cloud Server Connection - where the current repository is a Pro Cloud server repository, this displays in the System Output window: the version details, the response of a ping to that Pro Cloud Server and the timing of a simple query • Read Me - displays the Readme.txt file, which details the changes and enhancements in Enterprise Architect, build by build • About EA - displays a window showing your installation details, including the program version, your registration key, your repository connection, the Enterprise Architect edition and your user id
Home Page	Click on this option to open the Home page of the Sparx Systems web site.
Libraries	<p>Click on the drop-down arrow to display these commands;</p> <ul style="list-style-type: none"> • Learning Center - displays information from the Learning Center as a view in the central workspace area • Download Library - Opens the web page for the Learning Center library, from which you can download the Learning Center into your file system: https://sparxsystems.com/resources/libraries/index.html • Manage Library - install, enable and disable Library files
Register	Click on this option to open the 'License Management' dialog and register a new Enterprise Architect license key.

Design Ribbon

The 'Design' ribbon is used to develop and visualize a model by creating diagrams, matrices and lists of important aspects of the system. Requirements and other specifications can be created and viewed and, regardless of the technology or language of expression, representations can be created, viewed and tied together to form either blueprints of a system to be implemented or documentation of an existing system.

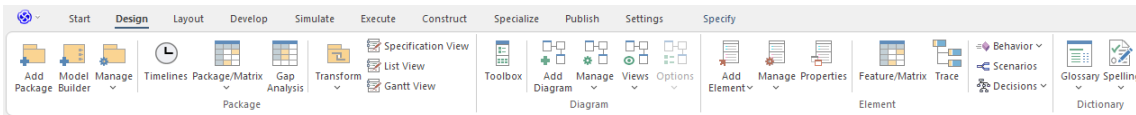

Panels

Panel	Description
Package	The 'Package' panel provides facilities to create and manage a model. New models can be added that typically contain a number of other Packages. These Packages form the structure of the model and can be used to group elements, diagrams or other Packages. You can work on the contents of a Package as a series of textual descriptions in the Specification Manager. A Package can also be viewed as a list of elements that will include other Packages, or as a Gantt chart describing the allocation of resources to the elements in the Package. Snapshots of Packages - including the complete model - can be taken and comparisons made to the current Package.
Diagram	The 'Diagram' panel contains a set of facilities for creating and managing diagrams and the elements they contain. Diagrams are a useful way of presenting and visualizing a model's elements and their connections. Different types of diagram can be easily constructed using the Diagram Toolbox, each page of which provides the elements and connectors for creating a specific type of diagram. Any diagram can be enhanced by a range of overlays that transform the diagram into an expressive view such as a Kanban board, a Roadmap diagram, or swimlanes that allow elements to be allocated to different aspects such as responsibility or ownership. A diagram can also be viewed in other formats such as a list of elements, or a Gantt chart describing the allocation of resources to the elements, or as a textual specification.
Element	The 'Element' panel provides facilities to create, edit and manage the elements that are the building blocks of models. Elements can be created and specified with attributes, operations, Receptions, Tagged Values, Scenarios, Requirements and Constraints.
Dictionary	The 'Dictionary' panel provides options to check the spelling in the current Package or the whole model, and to create and edit entries in the Project Glossary.

Package Panel

The 'Package' panel provides facilities to create and manage folders (Packages). New models can be added that typically contain a number of other Packages. These Packages form the structure of the model and can be used to group elements, diagrams or other Packages. A Package can also be viewed as a list of elements that will include other Packages, or as a Gantt chart describing the allocation of resources to the elements in the Package.

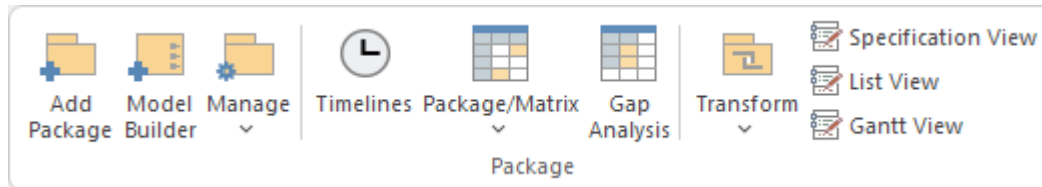

Available Facilities

<p>Add Package</p>	<p>Click on the icon to create a new child Package under the currently selected Package. The 'New Package' dialog displays, on which you specify whether to create the Package from a Pattern (with child structures), with a child diagram, or as a Package only.</p>
<p>Model Builder</p>	<p>Click on the icon to display the Model Builder, which provides Patterns from a wide range of technologies that you can use to quickly generate new models in your project.</p>
<p>Manage</p>	<p>Click on the drop-down arrow to select from a number of facilities that you can use to manage Packages in the model.</p> <ul style="list-style-type: none"> • Properties - maintain the properties of the current Package, using the 'Properties' dialog • Update Status - provide a bulk update on the Status, Phase and Version of the selected Package and its elements • Lock - display the 'Lock Package' dialog for the selected Package, on which you restrict changes to the Package • Clone Structure as New Version - copy the structure of the selected Package and paste it into the Browser window as a new Package and contents; a prompt displays for you to enter a version number for the new Package, followed by a browser on which you select its parent Package • Validate - display a short menu of options to create validation rules and run and cancel a validation of the current Package • Manage Baselines - display the 'Baselines' dialog for the selected Package, to create and compare Baselines of the Package with the current version (Ctrl+Alt+B) • Find Baselines - execute a report that finds and lists all the Baselines in the model • Level Numbering - toggle the display of automatically applied level numbering within the Specification Manager and the Browser window, for elements within the currently displayed Package • Auto Naming - apply configured auto naming conventions to existing elements in the selected Package • Report Options - display a dialog on which you specify whether to include the

	<p>selected Package in generated reports, or specifically exclude it from the reports</p> <ul style="list-style-type: none"> • DBMS Options - display the 'Manage DBMS Options' dialog to change the DBMS Type and/or Owner of one or more database objects • Copy to Clipboard - immediately copy the selected Package to the clipboard • Paste from Clipboard - paste a Package held on the clipboard as a child of the selected Package • Search for Package - display the Find in Project view, pre-loaded with the 'Find Package' search to locate Packages of a specific name or type • Browse for Package - display a 'Find Package' dialog listing only Packages, through which you can easily locate and select a specific Package from within the model hierarchy (Ctrl+Shift+Alt+P)
Timelines	<p>Click on this icon to display the 'Timelines' window. The Timelines window provides facilities for viewing and managing snapshots and baselines associated with diagrams, packages and individual elements as they change over time, during the development of your model.</p>
Package/Matrix	<p>Click on this icon to examine how sets of elements in one Package are linked to each other, or to elements in another Package, using the Relationship Matrix. You can also add and delete relationships using the Matrix. Select options to set the current Package as the source, target, or both.</p>
Gap Analysis	<p>Click on this icon to explore the implementation of features in the model, and to identify potential gaps between solution architectures, using the Gap Analysis Matrix.</p>
Transform	<p>Click on the drop-down arrow to display options for applying Transformation Templates in building physical models from more abstract content.</p> <ul style="list-style-type: none"> • Apply Transformation - display the 'Model Transformation' dialog, from which you select and apply a model transformation on the elements of the current Package • Transform Selection - display the 'Model Transformation' dialog, from which you define and perform one or more transformations on the selected elements, to generate new model content • Transform Templates - edit and configure the templates used to perform transformations, in the Transformation Editor view • Help - display the <i>Model Transformation</i> Help topic
Specification View	<p>Click on this icon to display the Specification Manager, a document-based interface to a selected Package in the model, providing the means of creating and reviewing elements as text representations of objects in the Browser window. When you select this option, the 'Design' ribbon changes to the 'Specification-Specify' ribbon.</p>
List View	<p>Click on this icon to display the selected Package in the Package Browser window, in List View mode.</p>
Gantt View	<p>Click on this icon to display the selected Package in the Package Browser window, in Gantt View mode.</p>

Diagram Panel

The 'Diagram' panel contains a set of facilities for creating and managing diagrams and the elements they contain. Diagrams are a way of presenting and visualizing a model's elements and their connections. They can be enhanced by a range of overlays that transform the diagram into an expressive view such as a Kanban board, a Roadmap diagram, or swimlanes, which allow elements to be allocated to different aspects such as responsibility or ownership. A diagram can also be viewed in a number of other formats, such as a list of elements or a Gantt chart describing the allocation of resources to the elements.

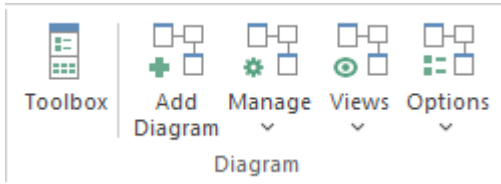

Available Facilities

Facility	Description
Toolbox	Click on this icon to display the Diagram Toolbox (if it is not already open); the Diagram Toolbox is a panel of icons specific to a diagram type that you can use to create elements and connectors on a diagram.
Add Diagram	Click on this icon to create a new diagram under the selected Package or element. The 'New Diagram' dialog displays, through which you can create a new diagram of any type under any technology supported by Enterprise Architect, based on a diagram Pattern.
Manage	<p>Click on the drop-down arrow to display a list of options for actions to apply to the selected diagram.</p> <ul style="list-style-type: none"> • Properties - maintain the properties of the current diagram, using the diagram 'Properties' dialog • Lock - display the 'Lock Diagram' dialog for the currently-open diagram, on which you restrict changes to the diagram • Clone as New Version - copy the currently-selected diagram in the Browser window and paste it into the Browser window as a new diagram; a prompt displays for you to enter a version number for the new diagram, followed by a browser on which you select its parent Package • Compare to Baseline - Compare the current diagram with a previously-captured Baseline of the diagram • Add to Working Set - add the diagram to a working set to open when you open the model • Save as Profile - Save the current diagram as a Profile • Swimlanes - divide the currently-open diagram into logical areas or partitions using the 'Swimlanes and Matrix' dialog • Kanban - convert the currently open diagram to Kanban format, using the 'Kanban' dialog • Roadmap - convert the currently open diagram to a roadmap with a timescale, using the 'Roadmap options' dialog • Search for Diagram - display the Find in Project view, pre-loaded with the 'Diagram Details' search to locate diagrams of a specific name

	<ul style="list-style-type: none"> • Browse for Diagram - display the 'Select Classifier' browser, through which you can locate and open a diagram in your model
Views	<p>Click on the drop-down arrow to display a list of options to display the currently open and selected diagram:</p> <ul style="list-style-type: none"> • In the standard graphical display format • As a tabular, editable list of elements (Diagram List) • In a Gantt Chart format, showing the Project Resources assigned to each element • With each element represented by a text description in the Specification Manager • With every relationship shown in a matrix of the source and target elements, in the Relationship Matrix • In the Construct View, representing the diagram as an element hierarchy showing element type, order of display and any parent-child structures • In the Inline Specification View - for the graphical display format, select between displaying and hiding a Specification view of the diagram elements in the right half of the diagram
Options	<p>Click on the drop-down arrow to display a list of options for managing the diagram's behavior.</p> <ul style="list-style-type: none"> • Configure Z Order - display the 'Modify Z Order' dialog, on which you set the Z order of each element on the diagram • Make all Elements Selectable - click on this option to make all the elements on the current diagram selectable, so that they each can be worked on • Change Type - change the diagram type • Sequence Communication Messages - (in a Communication diagram) change the sequence of messages • Auto Reload Changed Diagrams - automatically reloads open diagrams that have been saved by other users within the last 60 seconds

Notes

If an element is:

- Selectable, you can move it around the diagram and perform right-click context-menu operations
- Unselectable, you cannot move it around the diagram and the only right-click operation available is to make the element selectable

The 'Make all Elements Selectable' option has no effect on double-click operations on the element, such as displaying child diagrams.

Element Panel

The 'Element' panel provides facilities to manage elements, which are the building blocks of models. Elements can be created and specified with attributes and operations. You can also define scenarios for the activities that the element represents.

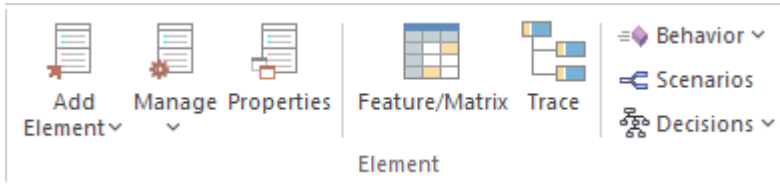

Available Facilities

Facility	Description
Add Element	<p>Click on the drop-down arrow to display a short list of options for adding elements to the model:</p> <ul style="list-style-type: none"> • Element - define and add a new element to the currently-selected Package or element and, if required, the currently open diagram, using the 'New Element' dialog • Multiple Elements - add a number of individual elements to the currently-open diagram, using the 'Create Multiple Elements' dialog • Related Element - identify elements that are related to the currently selected element and, if they are not on the currently-open diagram, add them to it • Any Element - add any existing element to the currently-open diagram; the option displays the 'Select Element' browser, which you use to locate the element to add
Manage	<p>Click on the drop-down arrow to display a list of commands you can use to identify, research, update and protect the element you have selected in a diagram or in the Browser window.</p> <ul style="list-style-type: none"> • Clone Element as New Version - copy the structure of the selected element and paste it into the Browser window as a new element and contents; a prompt displays for you to enter a version number for the new element, followed by a browser on which you select its parent Package or element • Lock - open the 'Lock Element' dialog through which you can set or clear editing locks on the selected element • Lock Element with Children - open the 'Lock Element' dialog through which you can set or clear editing locks on the selected element and all child elements of that element • Edit Linked Document - open the Linked Document editor for the Linked Document on the currently-selected element • Find Elements with Linked Documents - display the Find in Project view, pre-loaded with an executed search for elements that have Linked Documents; right-click on an item and select the 'Edit Linked Document' option to review the element's document • Find Elements with Linked Documents modified recently - opens the Find in Project view preloaded with an executed search for elements that have Linked Documents that have updated within the last seven days (you can re-execute the search with a different number of days); right-click on an item and select

	<p>the 'Edit Linked Document' option to review the element's document</p> <ul style="list-style-type: none"> • Parents and Interfaces - add or delete Generalization and Realization relationships to Parent or Interface Classes, using the 'Set Parents and Interfaces' dialog • Overrides and Implementations - set the system to automatically override methods from parent Classes and from realized Interfaces, using the 'Override Operations/Interfaces' dialog • Template Parameters - display the 'Templates' dialog on which you can define Template Parameters and Binding Expressions for a Parameterized Class • Change Type - change the type of the selected element, using the 'Select Element Type' dialog • Find in Project Browser - highlight in the Browser window an element selected from a diagram • Find in Diagrams - find the selected element in every diagram in which it has been used; if the element is used in more than one diagram, the 'Element Usage' dialog displays • Search - display the Find in Project view, through which you can search for the use of any aspect of an element across the model • Bookmark - add or remove a Bookmark on the selected element on the diagram; the element is marked with a red triangle
Properties	Click on this icon to display the Properties Window Selector, a page of options for editing element properties, including Tagged Values and Linked Documents.
Feature/Matrix	If you have selected two elements in an open diagram, the Feature Matrix helps you to create and manage relationships between the features (attributes, operations and receptions) of those elements.
Trace	Click on this icon to follow the connections in a chain of elements, starting with a single element to establish the dependencies radiating from that element, using the Traceability window.
Behavior	<p>Click on this icon to display the Source Code editor, to create or edit Behavior code for the operations in the selected element, or in the parent of the selected operation. You have three options:</p> <ul style="list-style-type: none"> • Edit Behavior • Edit Internal Code • Edit (or View) Source Code <p>All three options display the Code Editor window, but show the appropriate features, code and editing options for the type of code identified by the option.</p>
Scenarios	<p>Displays the Scenarios View, on which you can:</p> <ul style="list-style-type: none"> • Construct the scenario step-by step, or • Import a text file that describes a scenario, or • Generate a scenario from an Activity diagram that was itself generated from a scenario (thus regenerating the scenario or importing it from another element)
Decisions	<p>Click on the drop-down arrow to display a short menu of options for working with Decision Tables for the selected element.</p> <ul style="list-style-type: none"> • Find Decision Models - executes a report on the Find in Project window, to locate all DMN models represented by an Artifact with the stereotype <<DMNSimConfiguration>>

	<ul style="list-style-type: none">• Add New Decision Model (Create from Pattern) - displays the Model Builder ready to generate a DMN Model from a Pattern (if the left hand panel header is not 'Decision Modeling', click on the  icon and select 'Requirements > Decision Modeling')• Find Simple Decision Tables - executes a report to locate and list all elements that contain Decision Tables• Create/Edit Simple Decision Table - Opens the Decision Tables window, through which you can create or edit a Decision Table on the current element• Help - display the top-level Help topic on Decision Models
--	---

Dictionary Panel

The 'Dictionary' panel provides options to create customized document templates, to check the spelling in the current Package or the whole model, and to create and edit entries in the Project Glossary.

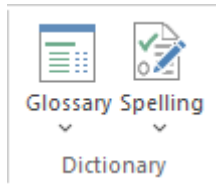

Available Facilities

Facility	Description
Glossary	<p>Click on this icon to display options for viewing and editing the terms defined in the Project Glossary:</p> <ul style="list-style-type: none"> • Glossary View - display the Glossary window, listing all terms defined in the Project Glossary • Edit - display the 'Glossary' dialog, which provides options to add, edit, and delete glossary terms and modify the display of terms • Implement a Model Based Glossary - display the <i>Create a Glossary as a Package Structure</i> Help topic
Spelling	<p>Click on this icon to access the project Spell Checking facilities. A short menu displays from which you can select:</p> <ul style="list-style-type: none"> • Spell Check Project - the 'Spell Check' dialog displays, on which you specify what model components to check • Spell Check Current Package - the 'Spell Check' dialog again displays, but in this context you do not have to set any parameters • Spelling Options - configure the spell checker using the 'Spelling Options' dialog

Layout Ribbon

The 'Layout' ribbon can be used to create sophisticated views of a model alignment of elements and sections to create high-quality diagrams. Diagrams are one of the most compelling ways of visualizing information. The appearance of elements in diagrams can be completely changed by adding border, fill and text colors, creating meaning and appeal. Diagram 'Filters and Layers' and Layout tools can be used to automatically change the appearance of diagrams, and Swimlanes and Roadmaps can be configured, adding rich presentations. A filter can be applied to hide elements that don't meet a specific condition, and a range of helpers can assist with element alignment.

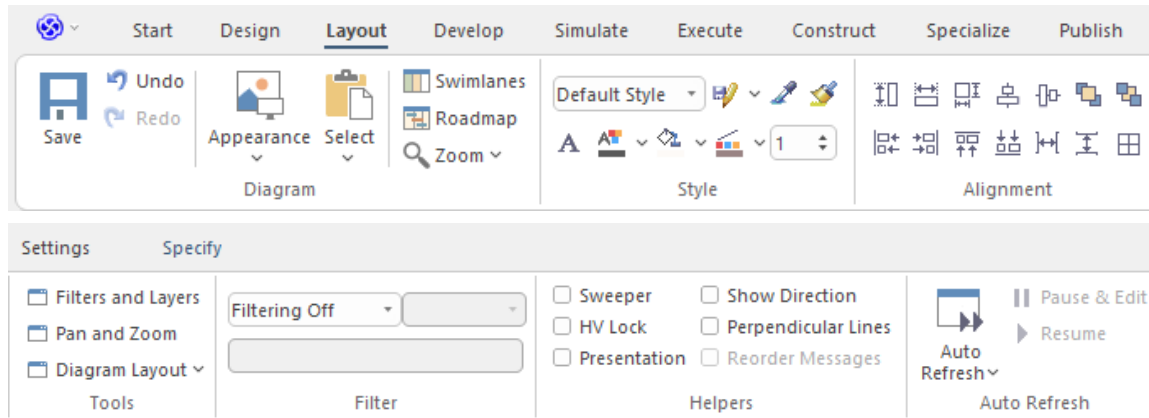

Panels

Panel	Description
Diagram	The 'Diagram' Panel provides a collection of tools for managing the use of diagrams and for manipulating the appearance and presentation of elements in a diagram.
Style	The 'Style' panel contains a range of tools for applying different styles to the elements in a diagram, to emphasize their importance or relevance in the context of the diagram. An element's fonts, fill and borders can be colored and styled, and the settings can be individually copied to other elements or saved as a style that can be applied to other elements as a group.
Alignment	The 'Alignment' panel provides a series of tools that can be used to refine the positions of the diagram's elements relative to each other. Groups of elements can be selected and their edges or centers aligned vertically or horizontally. An element's position in the visual stack can be altered by moving them forward or backwards, and you can display a convenient grid that can be configured so that elements and connectors 'snap' into position on the grid.
Tools	The 'Tools' panel provides a series of facilities for laying out, viewing or filtering the elements in a diagram. These are tools that assist in working with large or detailed diagrams. Diagram Filters can be used to hide elements that aren't relevant in a certain context. The Pan and Zoom window helps you change a diagram's magnification, and to quickly traverse a large diagram. The Diagram Layout facility can automatically change and organize the layout of elements in a diagram.
Filter	The 'Filter' panel helps in emphasizing aspects of a diagram, filtering out elements so that only the relevant or important elements are clearly visible whilst the other elements are muted. The filtering can be based on a variety of element properties that can be set for exact matches, presence of text strings or ranges of dates. The tool is invaluable for quickly locating and visualizing particular elements in a

	diagram.
Helpers	The 'Helpers' panel contains a series of specialized tools for working with the elements in a diagram, to save time, preserve layouts and enhance visualization.
Auto Refresh	The 'Auto Refresh' panel provides access to the diagram Auto Refresh facilities, which assist in collaborative diagram design by providing improved support for multiple people giving input on the same diagram.

Notes

- You can also temporarily display an abbreviated toolbar of formatting options beside an element or connector; for:
 - Elements, select one or more elements on the diagram and click on the 'paintbrush' icon beside the element (and, for multiple selected elements, the  icon)
 - Connectors, right-click on the connector; the toolbar appears above the context menu
- To set the global appearance of all elements throughout a model, use the 'Preferences' dialog; select the 'Start > Appearance > Preferences > Preferences' ribbon option, then select 'Diagram | Standard Colors' and 'Diagram | Appearance' from the options tree
- To override the global appearance and define a default appearance for a selected element (or several selected elements) on all diagrams on which it occurs, right-click on the element and choose the 'Appearance | Default Appearance' option

Diagram Panel

The 'Diagram' panel provides a collection of tools for managing the use of diagrams and for manipulating the appearance and presentation of elements in a diagram.

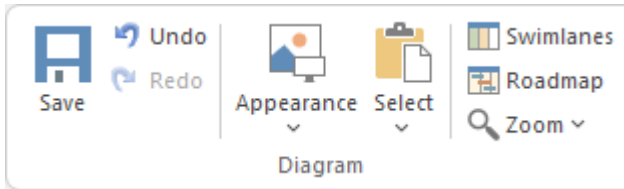

Available Facilities

To activate these facilities, open a diagram in the Diagram View. Some facilities are available even when a diagram is not open.

Facility	Description
Save	Click on the icon to save changes to the current diagram.
Undo	Click on this icon to reverse the last unsaved and un-reversed change made to the diagram. When working with diagrams, it is quite common for a modeler to make a series of changes and then decide to revert to a previous state of the diagram, using the Undo icon to step back through all the unsaved changes that have been made. For practical purposes, there is no limit to how many consecutive unsaved changes can be undone or redone.
Redo	Click on this icon to re-establish the last undone and unsaved change made to the diagram.
Appearance	<p>Click on the drop-down arrow to display a list of options for configuring the appearance of the current diagram.</p> <ul style="list-style-type: none"> Standard mode - defaults to selected to apply the normal rendition of the diagram; if the current diagram is in 'hand-drawn' or 'white board' mode, select this option to revert to normal display Hand Drawn Mode - display the current diagram in 'hand drawn' mode White Board Mode - display the current diagram in 'white board' mode Theme & Appearance Options - set the theme and appearance options for all diagrams that you review, using the 'Diagram > Themes' page of the 'Preferences' dialog Hide Page Borders (All Diagrams) - hide the printable-page border lines on all diagrams that you review; deselect the option to redisplay the borders (overridden by the 'Hide page borders (current diagram)' setting on the 'Diagram' page of the 'Properties' dialog for the diagram) Show Diagram Property Note - display the diagram property note on the current diagram Set Visible Relationships - display the 'Set Visible Relations' dialog through which you select the relationship connectors to show or hide on the current diagram Show Status Colors (All Diagrams) - display status colors on the status compartment or borders of all status-applied elements on all diagrams you review; deselect to display the elements with the default element fill and

	<p>shadow colors</p> <ul style="list-style-type: none"> • Configure Status Colors - set the status types and colors, using the 'Status' page of the 'General Types' dialog • Reset Local Element Appearance - for selected elements or all elements on the diagram, reset the fill, line and font colors and line width from the locally-set values (via the 'Layout > Style' ribbon panel, for example) to the values defined at the next level (that is, default values set on those elements (the F4 / 'Default Appearance' dialog) or on all elements ('Start > Preferences > Preferences > Diagram > Standard Colors' page) • Reset Default Element Appearance - for selected elements or all elements on the diagram, reset the fill, font and line colors and the line width from the F4 / 'Default Appearance' dialog values to the 'Standard Colors' page default; this then updates all diagrams in the model that also display those elements • Set Local Appearance as Default - for selected elements or all elements on the diagram, reset the F4 / 'Default Appearance' dialog values of the fill, font and line color and line width to the locally-set values of the selected elements (those elements will change to these colors in any diagram they are on, unless they are not overridden by values set locally or by stereotype)
<p>Select</p>	<p>Click on the drop-down arrow to display a list of options for selecting, copying and pasting elements on the current diagram.</p> <ul style="list-style-type: none"> • Select All Elements - select every element in the diagram • Select Elements by Type - specify an element type and - if appropriate - stereotype, and select all elements of that type in the diagram • Copy Selected Element(s) - copy all selected elements to the clipboard • Clear Current Selection - clear all selected elements in the diagram • Make All Elements Selectable - set all elements in the current diagram to Selectable, so that you can move them around the diagram and perform operations on them (make elements unselectable by right-clicking on them and clicking on the 'Unselectable' option) • Paste as Reference - paste elements from the clipboard into the diagram as links to the original elements (the elements being copied from a different diagram) • Paste as New - paste elements from the clipboard into the diagram as new elements; the 'Paste Elements as New' dialog displays, on which you change the names of the new elements • Paste Image as Element - paste a single image of the copied element(s) and any connectors between them from the clipboard into the current diagram; the image is enclosed within a System Boundary, and the element images cannot be selected or moved within the boundary • Autosize Selected Elements - returns the selected element(s) to the default size for the element type, or to the minimum size that can show the element contents; the resizing operates from the center of the element, so that you do not have to reorganize the diagram layout
<p>Swimlanes</p>	<p>Click on this icon to divide the currently-open diagram into logical areas or partitions using the 'Swimlanes and Matrix' dialog on the diagram.</p>
<p>Roadmap</p>	<p>Click on this icon to convert the currently open diagram to a Roadmap with a timescale, using the 'Roadmap options' dialog.</p>
<p>Zoom</p>	<p>This Zoom option provides a number of zoom settings that you can apply to your diagram:</p> <ul style="list-style-type: none"> • Clear

- 50%
- 60%
- 75%
- 80%
- 100%
- 150%
- 200%

When you select a zoom level here, it persists when you close and re-open the diagram.

The 'Clear' option resets the diagram's Zoom level to the default; that is, the Zoom level that the diagram was created at. This option only affects diagrams when the 'Base Zoom' setting from the 'Start > Appearance > Preferences > Preferences > Diagram > Appearance' page is set to a value other than 'None'.

Style Panel

The 'Style' panel provides a range of tools for applying different styles to the elements and connectors in a diagram, to emphasize their importance or relevance in the context of the diagram. An element's fonts, fill and borders, and a connector's line, can be colored and styled, and the settings can be individually copied to other elements and connectors, or grouped and saved as a style that can be applied to other elements and connectors.

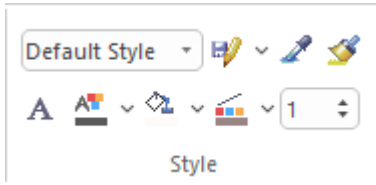

Available Facilities

Facility	Description
Style List	Click on the drop-down arrow on this field and select an existing style to apply to the selected object(s) in the diagram.
Save Style	Click on this icon to display a short menu of options for creating styles. <ul style="list-style-type: none"> Save as New Style - save the style of the selected object under a new name (for example, after changing the appearance of the object); a dialog displays in which you type the new style name, and when you click on the OK button the style is added to the 'Style List' field Save Style - save the style of the object under its existing style name (after changing the appearance of the object) Refresh List - change the 'Style List' field setting back to 'Default Style' Delete Current Style - delete the style currently shown in the 'Style List' field; the field reverts to 'Default Style' but the objects using that style stay as they are
Get Style	Click on this icon to copy the style of the currently selected object, to immediately apply to other objects.
Apply Style	Click on this icon to apply the style copied using the 'Get Style' icon to the currently selected object. You can keep clicking on new objects and on this icon to apply the style to several objects. As long as the style characteristic applies to the object (such as line width and line color) you can apply the style to any kind of object, although you would usually apply a style to closely related objects.
Set Font	Click on this icon to set the text font, style, size and effects for the selected element(s). (You can also select from a small range of text colors.)
Text Color	Click on this icon to select from a wide range of colors in which to display the text of the selected element(s).
Fill Color	Click on this icon to select from a wide range of colors to set as the fill color of the selected element(s).
Line Color	Click on this icon to select from a wide range of colors to set for the borders of the

	selected element(s) or lines of the selected connector.
Line Width	Click on the 'spinner' arrows to set the selected element border or connector line width to a value between 1 (thinnest) and 5 (thickest).

Alignment Panel





The 'Alignment' panel provides a series of tools that can be used to refine the positions of the diagram's elements relative to each other. Groups of elements can be selected and their edges or centers aligned vertically or horizontally. An element's position in the visual stack can be altered by moving them forward or backwards, and you can display a convenient grid that can be configured so that elements and connectors 'snap' into position on the grid.



Available Facilities

Most of the options on this panel become available when you select two or more elements together (press Ctrl or Shift as you click on the elements). Usually, the last-selected element is the reference element against which the others align; this element is indicated by a hatched border.

Facility	Description
Make Same Height	Click on this icon  to make all selected elements the same height as the reference element.
Make Same Width	Click on this icon  to make all selected elements the same width as the reference element.
Make Same Size	Click on this icon  to make all selected elements the same height and width as the reference element.
Align Vertically	Click on this icon  to align the centers of all selected elements vertically with the center of the reference element.
Align Horizontally	Click on this icon  to align the centers of all selected elements horizontally with the center of the reference element.
Bring to Top	Click on this icon  to move the selected elements to the top of the diagram relative to other elements (the top of the Z-Order).
Send to Back	Click on this icon  to move the selected elements to the back of the diagram relative to other elements (the bottom of the Z-Order).
Align Left	Click on this icon  to align the left edges of all selected elements vertically with the left edge of the reference element. Shortcut: Ctrl+Alt+Left Arrow
Align Right	Click on this icon  to align the right edges of all selected elements vertically with the right edge of the reference element. Shortcut: Ctrl+Alt+Right Arrow

Align Tops	<p>Click on this icon  to align the top edges of all selected elements horizontally with the top edge of the reference element.</p> <p>Shortcut: Ctrl+Alt+Up Arrow</p>
Align Bottoms	<p>Click on this icon  to align the bottom edges of all selected elements horizontally with the bottom edge of the reference element.</p> <p>Shortcut: Ctrl+Alt+Down Arrow</p>
Space Horizontally	<p>Click on this icon  to evenly separate the selected elements by the same amount horizontally.</p>
Space Vertically	<p>Click on this icon  to evenly separate the selected elements by the same amount vertically.</p>
Grid and Placement Options	<p>Click on this icon  to display a menu of options for the Standard Grid and Smart Placement features.</p> <p>Standard Grid: Standard Grid ensures that elements 'snap' to the nearest grid point when they are moved or resized.</p> <p>Smart Placement: When moving or resizing elements: automatically aligns element edges and centerlines with edges and centerlines of nearby elements, automatically spaces elements at equal distances from each other and spaces them evenly. For Sequence diagrams, this feature helps in aligning Notes on Messages.</p> <p>Please refer to <i>Move Elements Within Diagrams</i> for a full description of the options.</p>

Tools Panel

The 'Tools' panel provides a suite of facilities for aligning, viewing or filtering the elements in a diagram. These are tools that assist in working with large or detailed diagrams. Filters and Layers can be used to separate out elements that aren't relevant in a certain context. The Pan and Zoom window helps you change a diagram's magnification, and to quickly traverse a large diagram. The Diagram Layout facility can automatically change and organize the layout of elements in a diagram.

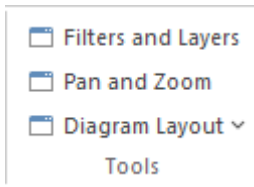

Available Facilities

Facility	Description
Filters and Layers	Click on this icon to display the 'Filters & Layers' window, which you use to create and apply filters for selectively muting parts of the diagram that are not relevant to an aspect you are investigating.
Pan and Zoom	Click on this icon to display the Pan & Zoom window, which helps you to scan across large diagrams and 'dive into' areas of interest.
Diagram Layout	<p>Click on this icon to display a menu of options that you can use to select, configure and apply a wide range of diagram layouts to the current diagram. These options include:</p> <ul style="list-style-type: none"> • Apply Default Layout - automatically apply the default standard Digraph layout to the current diagram • Open Diagram Layout Tools - display the 'Layout Tools' dialog, through which you can select, configure and apply one of the predefined diagram layouts to the current diagram • <diagram layouts> - the eleven predefined diagram layouts, each option automatically applies the current settings for that layout from the 'Layout Tools' dialog to the current diagram; note that the 'Digraph' option applies any settings you have adjusted, whereas the 'Apply Default Layout' option ignores such adjustments

Filter Panel

The 'Filter' panel helps in emphasizing aspects of the currently-open diagram, quickly filtering out elements outside a context so that only the relevant or important elements are clearly visible whilst the other elements are muted. The context can be derived from a variety of element properties (as defined in the Properties window), some of which can be set to an exact match, the presence of text strings or a date range. The tool is invaluable for quickly locating and visualizing particular elements in a diagram.

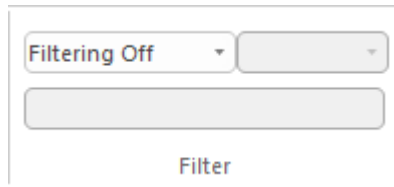

Fields

The three fields are unlabelled and are referred to by their position on the panel.

Field	Description
Top Left	<p>This field identifies the type of filter to apply. It defaults to the value 'Filtering Off'. Click on the drop-down arrow and select the filter type.</p> <p>To expose the full list of filter types, either use the vertical scroll bar or drag the 'dotted line' bar down as far as is necessary. The filter types include:</p> <ul style="list-style-type: none"> • Relationships - filters for elements that are the source or target of the same type of connector as the selected element • Hierarchy - filters for elements on the diagram in the same hierarchy as the selected element, both above and below that element in the hierarchy • Name / Alias - filters for elements having the specified text string in the 'Name' or 'Alias' fields • Alias - filters for or against elements having the specified text string in the 'Alias' field • Author - filters for or against elements created by the specified author(s) (as shown in the 'Author' field) • DateCreated - filters for or against elements created before, on or after the specified 'Created' date • DateModified - filters for or against elements modified before, on or after the specified 'Modified' date • Difficulty - filters for or against Requirement-type elements (Change, Feature, Issue) of the specified difficulty (see the element's 'Properties' dialog 'General > Main' page) • GenType - filters for or against elements of the specified code generation language (such as Java) specified in the 'Language' field • Filename - filters for or against elements having the specified code generation file path and name in the 'Filename' field • Keywords - filters for or against elements having the specified text in the 'Keywords' field • Name - filters for or against elements having the specified text string in the 'Name' field • Notes - filters for or against elements having the specified text string in the 'Notes' field (see the element's 'Properties' dialog, 'General' page)

	<ul style="list-style-type: none"> • ObjectType - filters for or against elements having the specified object type as defined in the 'Type' field • Phase - filters for or against elements having the specified phase as defined in the 'Phase' field • Version - filters for or against elements having the specified object type as defined in the 'Version' field • Priority - filters for or against Requirement-type elements (Change, Feature, Issue) of the specified priority (see the element's 'Properties' dialog 'General > Main' page) • RequirementType - filters for or against Requirement-type elements (Change, Feature, Issue) of the specified type (see the element's 'Properties' dialog 'General > Main' page) • Scope - filters for or against elements having the specified scope value, as defined in the 'Scope' field ('Details' page of the 'Properties' dialog, 'Advanced' section of the Properties window) • Status - filters for or against elements having the specified status, as defined in the 'Status' field • Stereotype - filters for or against elements having the specified stereotype as defined in the 'Stereotype' field • Selectable - filters for or against elements that have been flagged as selectable, using the element context menu • Printable - filters for or against elements that have been flagged as printable, using the element context menu <p>For some filter types, one or both of the remaining two fields might not be required and they will be grayed out.</p>
<p>Top Right</p>	<p>This field defines the operator to apply to any property or value you define; that is, whether the element property or text contains, is equal to, or is not equal to the defined value, or is within a specified range of values.</p> <p>Click on the drop-down arrow and select the appropriate operator.</p>
<p>Bottom</p>	<p>Type the value or range of values to be matched against the element property or text.</p>

Helpers Panel

The 'Helpers' panel contains a series of specialized tools for working with the elements in a diagram. These perform useful function that will save time, preserve layouts and enhance visualization. The 'Sweeper' and 'HV Lock' tools move multiple elements vertically, horizontally or diagonally in the diagram. The 'Presentation' tool can be used to show which element is in focus during a workshop or meeting. The 'Show Direction' tool indicates the direction of relationships connected to the selected element.

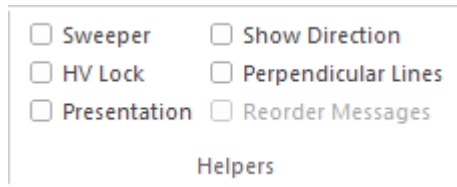

Available Facilities

To apply each of these tools to your diagram, click on the checkbox against the tool name. The options remain selected across diagrams and work sessions until explicitly turned off again.

Facility	Description
Sweeper	When the Sweeper is on, you can move sections of the diagram in one direction vertically, horizontally or diagonally. Click on the diagram and move the cursor; the section of diagram ahead of the cursor in its direction of movement is moved in the same direction.
HV Lock	When the HV Lock is on, when you click on an element and start to move it horizontally or vertically, the movement becomes restricted to that direction. So if you start to move the element vertically, you cannot move it horizontally until you release the mouse button and start another movement. The lock prevents any diagonal movement.
Presentation	When the 'Presentation' option is selected, the borders of selected elements are a simple solid colored line. There are no diagram icons (such as the Quick Linker arrow), movement handles or hatching. You cannot select and work on connectors. Whilst you can still move and resize the element(s), you might use this option when you are examining element content rather than element placement on the diagram, or using the diagram for display rather than change.
Show Direction	When this option is selected, the physical direction of connectors on the selected element are indicated by color: incoming relationships are red, and outgoing relationships are green. If the element is not selected, the connectors are not color coded.
Perpendicular Lines	When this option is selected, connectors are forced to adopt a vertical or horizontal position when they are adjusted. Connectors that are not adjusted when this option is selected will remain at whatever angle they present. Not all types of connector are affected by this setting.
Reorder Messages	This option enables and disables the ability to swap the order of messages on a Sequence diagram. When this option is enabled, if you drag a message up or down a lifeline beyond the position of the next or previous message, the messages swap positions. If this option is disabled, then dragging a message will only extend or reduce the spacing between the message being dragged and its preceding message.

Auto Refresh Panel

The 'Auto Refresh' panel provides access to the diagram Auto Refresh facilities, which assist in collaborative diagram design by providing improved support for multiple people giving input on the same diagram, and allowing those users to monitor changes on a specific diagram.

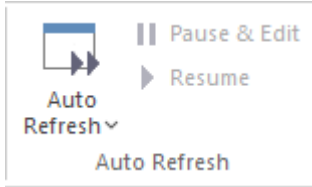

Available Facilities

Option	Description
Auto Refresh	Displays a menu of options to: <ul style="list-style-type: none"> • Disable Auto Refresh on this diagram (the default setting) • Enable Auto Refresh and poll for changes to the diagram every 7 seconds • Enable Auto Refresh and poll for changes to the diagram every 15 seconds • Enable Auto Refresh and poll for changes to the diagram every 30 seconds • Enable Auto Refresh and poll for changes to the diagram every 60 seconds • Pause Auto Refresh to enable you to edit the diagram • Resume Auto Refresh under the current interval after you have paused it to edit the diagram
Pause & Edit	Pauses Auto Refresh to enable you to edit the diagram.
Resume	Resumes Auto Refresh under the current interval after you have paused it to edit the diagram.

Develop Ribbon

The 'Develop' ribbon collects together all the tools for working with programming and database languages, including tools to reverse engineer, forward engineer and synchronize code and models. A system can be designed from requirements through to visual models of the components and code elements, and then generated to programming or database code.

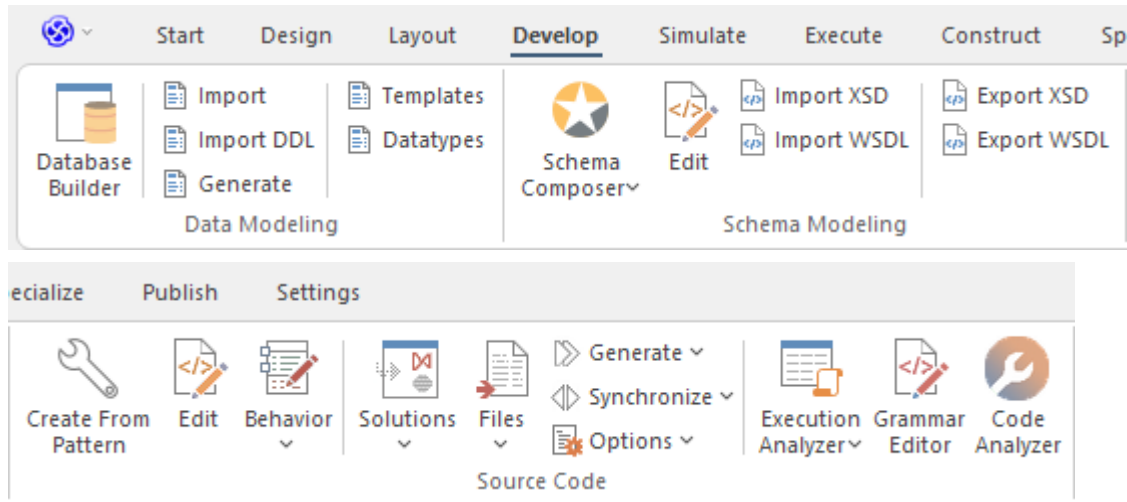

Panels

Panel	Description
Data Modeling	The 'Data Modeling' panel provides facilities for importing existing projects from other tools, to create or add to an Enterprise Architect project, and for importing code files in a range of programming languages into your model, creating new model elements that represent the classes in those files.
Schema Modeling	From the 'Schema Modeling' panel, you can access facilities for importing XSD files, WSDL files and DB Schema, and for generating XSD and WSDL files from your model. You can also edit XSL Transformations, and edit and debug language grammars.
Source Code	The 'Source Code' panel brings together a number of facilities for working with source code. Here, you can generate source code from the model and synchronize the model with updated source code. You can also locate, open, edit and merge source code files. Also available are the: <ul style="list-style-type: none"> • Execution Analyzer, in which you can specify how the model is used to generate a built product, including how an application will be compiled, debugged and simulated • Grammar Editor window, an advanced facility that allows you to view, add, edit and manage language grammars, used for importing source code, and • Code Analyzer that allows code metrics to be queried much faster than conventional methods

Data Modeling Panel

The 'Data Modeling' panel provides facilities for importing existing database projects from other tools, to create or add to an Enterprise Architect project, and for importing database schema and DDL files.

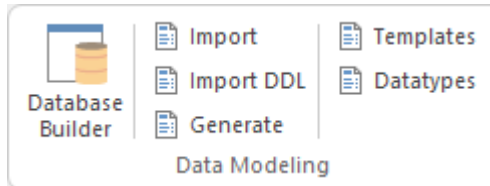

Available Facilities

Facility	Description
Database Builder	Click on this icon to add, edit and manage database models for a wide range of DBMS products, using the Database Builder.
Import	Click on this icon to display the 'Import DB schema' dialog, through which you can specify a database schema to import from a target DBMS.
Import DDL	Click on this icon to display the 'Import DDL Scripts' dialog, through which you can import DDL scripts from a specified directory in your file system, to create Database Model objects in your Enterprise Architect model.
Generate	Click on this icon to display the 'Generate DDL' dialog, from which you can export the current model selection as DDL script, targeting a particular DBMS.
Templates	Click on this icon to display the 'DDL Template Editor', in which you can edit the templates used to create DDL scripts for each DBMS.
Datatypes	Click on this icon to display the 'Database Datatypes' dialog to add, modify and delete database datatypes.

Schema Modeling Panel

From the 'Schema Modeling' panel, you can access facilities generating and importing DB Schema and for importing and exporting XSD files and WSDL files from your model.

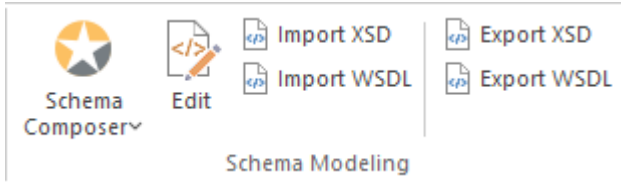

Available Facilities

Facility	Description
Schema Composer	<p>Click on the drop-down arrow to display options for creating and managing custom profiles for the generation of industry-specific XSD files.</p> <ul style="list-style-type: none"> Open Schema Composer - display the Schema Composer view, which you use to create Schema profiles and generate XSD files from them Import for Schema Composer - import a Schema Composer profile from an external file, using the 'Schema Importer' dialog Find Schema Composer Profiles - execute a standard search to locate all Schema Composer profiles in the project Help - display the <i>Schema Composer</i> Help topic
Edit	Displays an 'Open File' browser through which you locate and select an XSD/XML file to open in the Code Editor window.
Import XSD	Click on this icon to display the 'Import XML Schema' dialog for importing an XSD file to a model Package; choose a file to import and specify a range of options to apply when importing the file
Import WSDL	Click on this icon to display the 'Import WSDL' dialog, where you can choose a file to import into the selected Package
Export XSD	Click on this icon to display the 'Generate XML Schema' dialog for generating the current Package to an XSD file; specify a path for the export file and specify a range of options to apply when exporting the Package
Export WSDL	Click on this icon to generate either a «WSDLnamespace» stereotyped Package or a «WSDL» stereotyped Component (Document) to WSDL files

Source Code Panel

The 'Source Code' panel brings together a number of facilities for working with source code. Here you can import existing source code files into your model, creating new model elements that represent the classes in those files. You can select a Class in your model, then click a button to open the code editor window and automatically load the source code file associated with that Class. Facilities are also provided for:

- Issuing commands to generate source code from the model
- Synchronizing the model from the source code
- Performing code analysis
- Accessing tools such as the Debugger, Profiler, Execution Recorder and the Testpoints Window
- Working with language grammars
- Managing code templates and defining the way source code is imported into and generated from your model

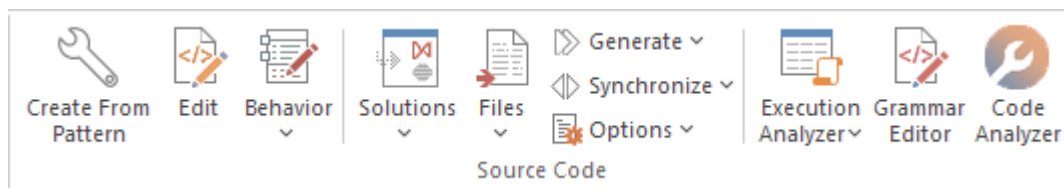

Available Facilities

Facility	Description
Create From Pattern	Click on this icon to display the Patterns window, through which you can generate: <ul style="list-style-type: none"> • Starter projects including model information, code and build scripts for one of several basic application types (on the 'Application Patterns' page) • Examples of key sections of code to generate Sequence diagrams, including a Class model, build scripts and related source code (from the 'VEA Examples' page)
Edit	Click on this icon to open a file browser through which you locate and open the required code file to edit.
Behavior	Click on this icon to display the Source Code editor, to create or edit Behavior code for the operations in the selected element, or in the parent of the selected operation. You have three options: <ul style="list-style-type: none"> • Edit Behavior • Edit Internal Code • Edit (or View) Source Code All three options display the Code Editor window, but show the appropriate features, code and editing options for the type of code identified by the option.
Solutions	Click on the drop-down arrow to display a list of options for importing project code from certain popular development products into the current project. For example: <ul style="list-style-type: none"> • Import a Visual Studio Solution • Import a Mono Solution • Import an Eclipse Project • Import a Netbeans Project

	<p>Having imported the material, you can perform a comparison between the external project source code and the Enterprise Architect model to check for Class differences, using the 'Compare with Model' option, and you can refresh the Enterprise Architect model to update it with any changes to the source.</p>
Files	<p>Click on the drop-down arrow to display a list of options for importing code files into the current model from a variety of sources, selecting from a range of popular coding languages.</p> <ul style="list-style-type: none"> • Edit New Source File - display the Code Editor window as a 'New File' document, enabling you to create and populate a new code file of whatever type and format you require • Import Directory - display the 'Import Source Directory' dialog, through which you import a complete directory tree in one pass; language and other options can be specified within the dialog • View Dry Run Log - If you have performed a source directory import with the 'Perform a Dry Run' option selected, a log file of that dry run is generated; this option displays that log file <p>You can also import:</p> <ul style="list-style-type: none"> • ActionScript Files • C Files • C# Files • C++ Files • Delphi Files • Java Files • PHP Files • Python Files • Visual Basic Files • VB .Net Files • Binary File - supported file types are: Java JAR files and .NET PE or IL format (exe, dll) • Windows .RC File (a Windows C/C++ .RC file), as a series of screen definitions <p>If you have developed model structures for any customized programming language, those languages are also included in the list.</p>
Generate	<p>Click on this icon to display options to generate source code for:</p> <ul style="list-style-type: none"> • The currently selected model element(s), or • A single element, with options, or • All elements in the current context <p>Source code is generated into the file that is associated with each individual element. Code is generated only for elements that are of type Class or Interface.</p>
Synchronize	<p>Click on this icon to display options to synchronize the currently selected model elements with their associated source code files, or to synchronize the whole Package containing the selected elements.</p>
Options	<p>Click on the drop-down arrow to display a list of options for managing templates, which determine the way source code is imported into and generated from your model.</p> <ul style="list-style-type: none"> • Edit Code Templates - display the Code Template Editor window, where you can review and edit the templates used for generating source code from your

	<p>model</p> <ul style="list-style-type: none"> • Set Package as Namespace Root - set the selected Package as the Namespace root, for code generation • Suppress Namespace - ignore the current subordinate Package when generating Namespaces and showing Package paths • Configure Local Paths - display the 'Local Paths' dialog, where you can set up and manage a list of Local Path definitions, used for path substitutions in collaborative environments • Configure Code Engineering Datatypes - manage the list of Datatypes that are used in Code Engineering • Define Preprocessor Macros - manage a list of preprocessor macros that will be used when C and C++ code is imported into the model • Reset Source Language - display the 'Manage Code Generation' dialog to change the source language and other generation options for all Classes in the selected Package • Set Live Code Generation - update your source code instantly as you make changes to your model
Execution Analyzer	<p>Click the drop-down arrow to access a menu of Analyzer tools.</p> <ul style="list-style-type: none"> • Edit Analyzer Scripts - display the Execution Analyzer window, where you can create and manage scripts that define the build, run, test, deploy and simulate functions for the current Package • Edit Active Script - display the Analyzer script editor to edit the currently-active Analyzer script • Show Testpoints Window - display the Analyzer Test Points window, to configure, execute and work with dynamic test suits and test cases • Find Test Suites and Test Sets - search the model for Test Suites and Test Sets • Open Debugger - display the Analyzer Debug window to facilitate debugging and testing of the current application • Open Profiler - display the Analyzer Profiler window, from which you can perform application performance profiling and execution inspection of the current application • Open Recorder - display the Analyzer Recording window, from which you can set recording points, record program execution and create diagrams based on recordings • Open Object Workbench - open a simple Object Testing window, from which you can make ad hoc calls on Object methods; available for Java and .NET objects
Grammar Editor	<p>Display the Grammar Editor window, an advanced facility that allows you to view, add, edit and manage language grammars, used for importing source code.</p>
Code Analyzer	<p>The Code Analyzer can perform very complex queries on source code repositories at lightning speed either locally or on a Sparx Intel Cloud service, allowing code metrics to be queried much faster than conventional methods.</p>

Simulate Ribbon

The 'Simulate' ribbon presents a range of tools for configuring, building and running simulations of models, in particular models of executable states, decision analysis, business process analysis and system behavior. The definition of a simulation is further supported by the facility to create JavaScript to control a simulation, including the use of mathematical solvers such as MATLAB and Octave.

Enterprise Architect also provides the ability to start, pause and resume execution of a simulation, as well as set break points and view Call Stacks or local variables. A number of pre-defined model searches are also provided to assist with locating model artifacts related to your simulations.

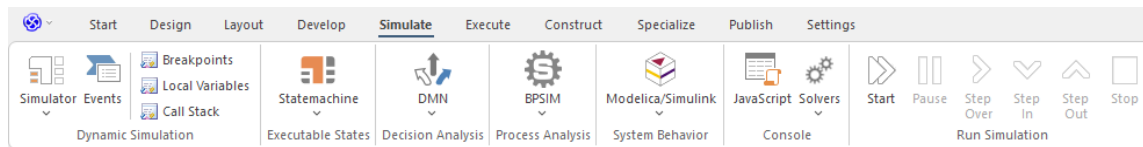

Panels

Panel	Description
Dynamic Simulation	The 'Dynamic Simulation' panel brings together a range of tools for working with Behavioral Model simulations. It provides access to a number of windows that allow you to control a simulation, set up simulation triggers and signals, set breakpoints, inspect local variables or view the Call Stack. It also offers a number of pre-defined model searches for retrieving recently modified StateMachines and Activity Graphs, and enables you to apply the appropriate Perspective and Work Space for the simulation you are performing.
Executable States	Executable StateMachines provide a means of rapidly generating, executing and simulating complex state models. In contrast to dynamic simulation of State Charts using Enterprise Architect's Simulation engine, Executable StateMachines provide a complete language-specific implementation that can form the behavioral 'engine' for multiple software products on multiple platforms. The 'Executable States' panel provides a number of facilities for working with Executable StateMachines. You can access facilities to configure Analyzer Scripts that determine how code is generated, compiled and executed for the Executable StateMachine. There are commands for you to generate, build and execute the code that runs the simulation, as well as a facility to view the generated code in the built-in code editor.
Decision Analysis	The 'Decision Analysis' panel helps you to perform simulations of models created under Enterprise Architect's implementation of the Decision Modeling and Notation (DMN) facility, developed by the Object Modeling Group (OMG). This facility enables you to open a DMN Simulation and set up DMN Expressions, and to locate and work from DMN Configuration Artifacts.
Process Analysis	The 'Process Analysis' panel provides facilities to manage and run BPMN simulation models, based on the BPSim standard.
System Behavior	The 'System Behavior' panel provides access to the 'SysML Simulation Configuration Manager' view, where you can configure and manage SysML-based simulations as well as access a pre-defined search to retrieve SysML Configuration Artifacts.

Console	The 'Console' panel provides options for working on JavaScript code, and specifically on the code for MATLAB and Octave Solvers.
Run Simulation	The 'Run Simulation' panel provides a number of buttons to control execution of an active simulation, namely Start, Pause, Step Over, Step In, Step Out and Stop.

Dynamic Simulation Panel

The 'Dynamic Simulation' panel brings together a number of tools for working with Behavioral Model simulations. It provides access to a range of windows that allow you to control a simulation, set up simulation triggers and signals, set breakpoints, inspect local variables or view the Call Stack. It also offers a number of pre-defined model searches for retrieving recently modified StateMachines and Activity Graphs, and enables you to apply the appropriate Perspective and Work Space for the simulation you are performing.

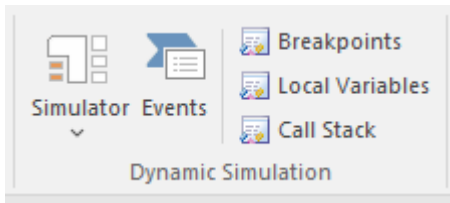

Available Facilities

Facility	Description
Simulator	<p>Click on this icon to display a short menu providing these options:</p> <ul style="list-style-type: none"> • Open Simulation Window - display the Simulator control window, from which you can manage, activate and control simulations • Find Simulations - opens the Start Page 'Search in Project' tab with the 'Simulation > StateMachine Diagrams' search loaded for execution (click on the 'Run' arrow); you can change the search to locate Activities, Executable StateMachines, Interactions, BPSim configurations and other objects related to running simulations • Recent StateMachines - opens the Start Page 'Search in Project' tab with the 'Simulation > Recent StateMachine Diagrams' search executed • Recent Activity Graphs - opens the Start Page 'Search in Project' tab with the 'Simulation > Recent Activity Diagrams' search executed • Apply Perspective - Displays the Model Builder, in which you select the Perspective to apply model structures appropriate to the simulations you intend to perform • Apply Workspace - apply the Simulation Workspace, which opens all of the relevant windows (Simulation, Simulation Events, Local Variables, Call Stack and Execution Analyzer windows) for Dynamic Simulation, and arranges them around the screen for ease of use • Help - display the <i>Dynamic Simulations</i> Help topic. <p>In the searches you can specify the time period (number of days prior to today) from which to draw the results.</p>
Events	Click on this icon to open the Simulation Events window, to work with signals and triggers that are used as input to the currently active simulation.
Local Variables	Click on this icon to display a list of Local Variables and their values from the current simulation. The simulation must be halted at a break point in order to display variables.
Call Stack	Click on this icon to display the Call Stack for the current simulation.

Executable States Panel

Executable StateMachines provide a valuable means of rapidly generating, executing and simulating complex State models. In contrast to dynamic simulation of State Charts using Enterprise Architect's Simulation engine, Executable StateMachines provide a complete language-specific implementation that can form the behavioral 'engine' for multiple software products on multiple platforms.

The 'Executable States' panel provides a number of facilities for working with Executable StateMachines. You can access facilities to configure Analyzer Scripts that determine how code is generated, compiled and executed for the Executable StateMachine. There are commands for you to generate, build and execute the code that runs the simulation, as well as a facility to view the generated code in the built-in code editor.

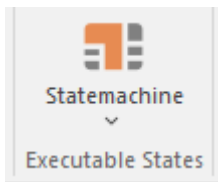

Available Facilities

Facility	Description
Statemachine	<p>Click on the drop-down arrow to display a list of options for working with Executable StateMachine Artifacts to configure, generate and run code-based simulations.</p> <ul style="list-style-type: none"> • Generate, Build and Run - generate, build and run the current Executable StateMachine Artifact, according to the Analyzer Script configuration • Generate - generate the current Executable StateMachine Artifact, according to the Analyzer Script configuration • Build - build the current Executable StateMachine Artifact, according to the Analyzer Script configuration • Run - start a simulation of the current Executable StateMachine Artifact, according to the Analyzer Script configuration • Find Executable Statemachines - run a pre-defined search to locate all Executable StateMachine Artifacts in the model • View Source - view the source code generated for the current Executable StateMachine Artifact • Analyzer Scripts - display the 'Execution Analyzer' dialog, where you can configure Analyzer Script options for the current Executable StateMachine Artifact • Apply Perspective - apply the Perspective for Executable StateMachines to your modeling environment; the Model Builder dialog displays, presenting the Executable StateMachine Patterns • Apply Workspace - apply the Simulation Workspace, which opens all of the relevant windows (Execution Analyzer, Simulation, Simulation Events, Locals and Call Stack windows) for Executable State simulation, and arranges them around the screen for ease of use • Help - display Help information about Executable StateMachines

Decision Analysis Panel

The 'Decision Analysis' panel helps you to perform simulations of models created under Enterprise Architect's implementation of the Decision Modeling and Notation (DMN) facility, developed by the Object Modeling Group (OMG). This facility enables you to open a DMN Simulation, set up DMN Expressions and locate and work from DMN Configuration Artifacts.

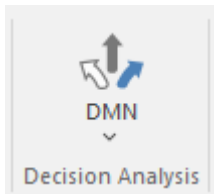

Available Facilities

Facility	Description
Open DMN Simulation	Select this option to open the DMN Simulation window, through which you can create and edit DMNSimConfiguration Artifacts, run a DMN simulation and generate and test a DMN Server.
DMN Expression	Select this option to display the DMN Expression window. The content of this window depends on the DMN component you select in a diagram or the Browser window. If you have not selected any component, the window is blank.
Find DMN Configuration Artifacts	Select this option to immediately execute a search for DMNSimConfiguration Artifacts in the model. The results of the search are listed on the Find in Project window.
Apply Perspective	Select this option to apply the Perspective for DMN to your modeling environment. The Model Builder dialog displays, presenting the DMN Patterns.
Apply Workspace	Select this option to apply the DMN Simulation Workspace, which opens the relevant windows (DMN Simulation, DMN Expression) for Decision Analysis simulation, and arranges them around the screen for ease of use
Help	Select this option to display the <i>DMN Decision Models</i> Help topic.

Process Analysis Panel

The 'Process Analysis' panel provides access to the Configure BPSim window, and also a pre-defined search to retrieve BPSim configuration Artifacts.



Available Facilities

Facility	Description
BPSIM	<p>Click on the drop-down arrow to display a short menu providing these options:</p> <ul style="list-style-type: none"> • Open BPSim Manager - display the Configure BPSim window, through which you can configure, execute and analyze simulations of BPSim models • Find BPSim Configuration Artifacts - open the Start Page 'Search in Project' tab and load a pre-defined set of search parameters to find Business Process Simulation configuration Artifacts containing simulation parameters for executing BPMN 2.0 simulations • Apply Perspective - apply the Perspective for BPSim to your modeling environment; the 'Model Builder' dialog displays, presenting the BPSim Patterns • Apply Workspace - apply the Process Analysis Simulation Workspace, which opens all of the relevant windows (Toolbox, Properties, Notes and Configure BPSim windows) for Process Analysis Simulation, and arranges them around the screen for ease of use • Help - display the <i>BPSim Business Simulations</i> Help topic

System Behavior Panel

The 'System Behavior' panel provides access to the Configure SysML Simulation view, where you can configure and manage SysML-based simulations as well as access a pre-defined search to retrieve SysML Configuration Artifacts.

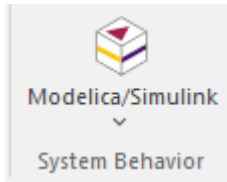

Available Facilities

Facility	Description
Modelica/Simulink	<p>Click on the drop-down arrow to access the SysML Simulation configuration and management view, or to access a pre-defined model search that retrieves SysML Configuration Artifacts.</p> <ul style="list-style-type: none"> • SysMLSim Configuration Manager - display the Configure SysML Simulation view to build and run simulations using SysML and OpenModelica or Simulink • Find SysMLSim Configuration Artifacts - open the Start Page 'Search in Project' tab and load a pre-defined set of search parameters to find SysMLSim Configuration Artifacts • Apply Perspective - apply the SysML Perspective to your modeling environment; the Model Builder dialog displays, presenting the SysML 1.5 Patterns, OpenModelica Case Studies and SysPhS elements • Apply Workspace - apply the System Behavior Simulation Workspace, which opens all of the relevant windows (Toolbox, Properties, Notes and Configure SysML Simulation windows) for System Behavior Simulation, and arranges them around the screen for ease of use • Help - display the (SysPhS Simulation) <i>Simulation</i> Help topic

Console Panel

The 'Console' panel provides options for working on JavaScript code for Dynamic Simulation, and specifically on the code for MATLAB and Octave Solvers in Mathematical Simulation.

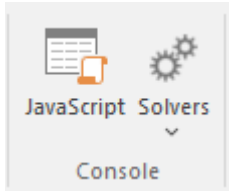

See the *Model Simulation* topics [Dynamic Simulation with JavaScript](#) and [Solvers](#).

Run Simulation Panel

The 'Run Simulation' panel provides a number of buttons to control execution of the active simulation.

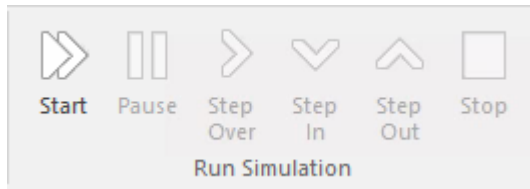

Available Facilities

Facility	Description
Start	Begin or continue execution of the currently active simulation.
Pause	Pause execution of the current simulation
Step Over	Step over a transition or a control path that enters a different process or StateMachine space
Step In	Step into a sub-process in the current simulation
Step Out	Step out of a sub-process or sub-machine state and return to the parent process or StateMachine
Stop	Halt execution of the current simulation at the current execution point.

Execute Ribbon

The 'Execute' ribbon provides a comprehensive set of facilities for running units of code and analyzing how the code executes, checking system use and data use and whether there are errors. If there are errors in the code, you can isolate them and correct them, testing those corrections as well.

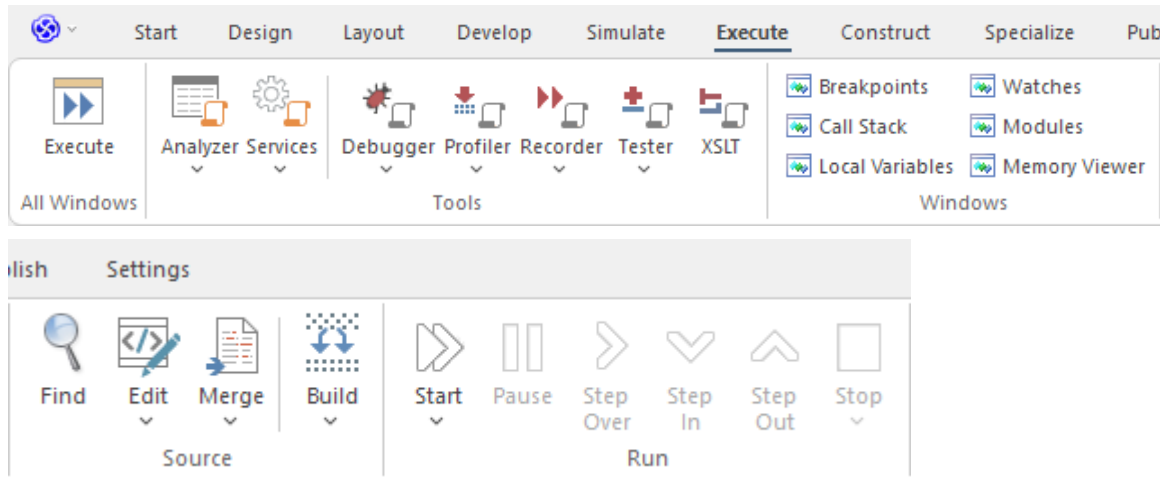

Panels

Panel	Description
All Windows	You can use the 'All Windows' panel to access a range of Window Selectors to select and open a window or a workspace.
Tools	The 'Tools' panel brings together a collection of tools for analyzing the execution of an application. The tools available are a fully featured Debugger, an execution Profiler and a stack trace Recorder. There are also facilities for running the application and recording Test Point output, for subsequent analysis. The 'Services' icon provides options to start, stop and test Satellite and Agent services, and to make use of the Code Miner.
Windows	The 'Windows' panel provides access to a suite of windows associated with the debugging process, each of which provides information on an aspect of the application being debugged, particularly at a breakpoint.
Source	The 'Source' panel provides a set of buttons for building an application that is being analyzed. The active Analyzer Script defines the behavior of the Analyze tools, by specifying the commands that are executed and the settings and parameters for those commands. After making modifications to the code base, you can simply click on 'Build'.
Run	The 'Run' panel provides the commands for running an application that is being analyzed. You simply click on buttons to begin execution of the updated application, pausing or stepping through code as required.

All Windows Panel

You can use the 'All Windows' panel to access a range of Window Selectors to select and open a window or a workspace.

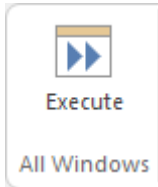

Available Facilities

Facility	Description
Execute	Click on this icon to display the Execute Window Selector. The Execute Window Selector provides access to the Simulation, Source Code, Visual Analysis and Process Execution windows and tabs. Click on the name of the required window to immediately open it.

Tools Panel

The 'Tools' panel brings together a collection of tools for analyzing the execution of an application. The tools available are a fully featured Debugger, an execution Profiler and a stack trace Recorder. There are also facilities for running the application and recording Test Point output, for subsequent analysis.

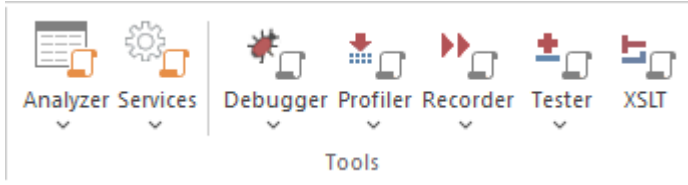

Available Facilities

Facility	Description
Analyzer	<p>Displays the Execution Analyzer window, which lists - by Package - all Analyzer Scripts defined in the model. From this window, you can create, edit and manage scripts that specify the commands and parameters required to build, test, run, debug, deploy and simulate your applications. The window's toolbar buttons provide for control of script tasks such as build, run, test and deploy, and also provide access to a range of debugging facilities.</p> <p>The icon also provides access to the Job Queue window. This window streamlines the process of working with Analyzer Scripts; when an Analyzer Script context menu option is executed (for example, 'Build') it is placed in a job queue; multiple jobs can be queued, and other work performed while the jobs are processed.</p>
Services	<p>These options enable you to start, stop and test local supporting VEA services. Those services might run a native Linux program, for example, or build a project.</p> <ul style="list-style-type: none"> • View Status of all Services - displays a window that lists the status of each Enterprise Architect service named in the config file, and its state • Satellite Service <ul style="list-style-type: none"> - Start - Stop - Test (Satellite service status) • Agent Service <ul style="list-style-type: none"> - Start - Stop - Test (Agent service status) • Code Miner Service <ul style="list-style-type: none"> - Start - reads the current service configuration and starts services that are configured to run and stops services that are not configured - Stop All - stops any services that are currently running - Edit Configuration File - prompts for the service config file to use, then opens it in an Enterprise Architect text editor - Auto Start with EA - automatically starts services having the 'status:ON' attribute when the model opens - Auto Stop on Close - automatically stops running services when Enterprise Architect is closed

Debugger	<p>Click on the drop-down arrow to display a list of options for starting and using the Debugger.</p> <ul style="list-style-type: none"> • Open Debugger - open the Debug window; this window provides a toolbar for controlling Debugger operations such as run, step-into, step-over, pause and also displays debug output messages • Start Debugging - start the application, according to the debug options of the active analyzer script • Attach to Process - display a list of executing processes - select and attach to a process for debugging purposes • Create Stack Diagram - create an Interaction diagram based on the current execution stack; available only when execution is halted at a breakpoint • Create marker set for class - creates a set of breakpoint markers for methods of the selected Class • Switch to Profiler - switch dynamically from the Debugger to the Profiler, allowing performance monitoring and execution tracing • Set as JIT Debugger - set Enterprise Architect as the default Just In Time debugger; for Windows systems only • Set as JIT Model - set the current model as the default on which to perform Just In Time debugging; for Windows systems only • Process First Chance Exceptions - enable processing of First Chance Exceptions • Apply Debug Layout - apply a workspace layout containing windows useful for debugging, set out in a convenient arrangement
Profiler	<p>The Profiler is used to record stack trace information for an application that is being analyzed, at pre-determined sampling intervals.</p> <p>Click on the drop-down arrow to display a list of commands for starting and working with the application Profiler.</p> <ul style="list-style-type: none"> • Open Profiler - open the Profiler window; this window provides a toolbar for controlling Profiler operations and displays a summary of the collected sample data • Attach to Process - display a list of executing processes - select and attach to a process to enable execution profiling and activity monitoring of that process • Start - reattach the Profiler to the last profiled application process (where available), otherwise start the application specified in the debug options of the active analyzer script and attach the Profiler to that application process • Resume - begin or resume collection of profiling data • Stop - detach the Profiler from the application process; the application process will continue to run - click on the Start button to re-attach to that process • Switch to Debugger - dynamically switch from Profiling to Debugging to allow finer grained inspection of application behavior • Create Report from Current Data - create a detailed execution call graph and overall summary, showing functions called and number of times a function was active when the Profiler inspected execution • Load Report from File - load a profiler report from a saved file • Save Report to File - save the collected profile data to a file • Stop Process on Exit - an option to stop the application process when the Profiler is detached from that process • Show Debug Output - optionally show debug output as the Profiler executes • Discard Fragments - discard partial stacktraces from samples • Discard Current Data - discard all collected sample data in preparation for a

	<p>new run</p> <ul style="list-style-type: none"> • Apply Profiler Layout - apply a workspace layout containing windows useful for application profiling, set out in a convenient arrangement
<p>Recorder</p>	<p>The Recorder is used to record information about function calls made by an application that is being analyzed.</p> <p>Click on the drop-down arrow to display a list of commands for starting and working with the Recorder.</p> <ul style="list-style-type: none"> • Open Recorder - open the Record & Analyze window; this window provides a toolbar for controlling Recorder operations such as run (the application), manual record, auto record, stop recording and also displays the recorded function call information • Attach to Process - attach the Recorder to an executing process • Start Recorder - start the application specified the debug options of the active analyzer script and attach the Recorder to that application process; recording will begin when execution hits a recording marker that has been set in the source code • Stop Recording - stop recording the execution trace of the application process; the application process will continue to run • Auto Record - automatically begin recording an execution trace, without manual intervention, once execution hits a recording marker that has been set in the source code • Manual Record - use the manual record functions to start and stop recording while stepping through source code in the Debugger • Step Thru - step through executing code while recording an execution trace • Save Recording to Model (Artifact) - save the recorded execution trace to a model artifact • Save Recording to File - save the recorded execution trace to a file in the local file system • Load Recording - load a recorded execution trace from a previously saved file • Clear Recording Data - discard any recorded execution trace in preparation for recording a new trace • Create Sequence Diagram - create a Sequence (Interaction) diagram from the current execution trace; requires that model and code are synchronized • Create Call Graph - create a Call Graph from the current execution trace; requires that model and code are synchronized • Create Class Diagram - create a Class diagram using the elements that are instantiated and accessed in the current recording • Create Test Point Diagram - create a Test Point diagram and Test Sets based on the elements and their active members that were hit during the recorded session • Synchronize Model to Source Code - synchronize the source code of the current application with the model, to ensure correct recording and creation of diagrams • Show/Hide Execution Point - show or hide the current execution point during the recording process; hiding this results in a faster recording time • Apply Recording Layout - apply a workspace layout optimized for use of the Recorder
<p>Tester</p>	<p>Test Points are a scheme by which rules and constraints governing the behavior of objects can be taken from the model to create Test Cases to verify the application.</p> <p>Click on the drop-down arrow to display a list of options for working with Test Points and Test Cases.</p>

	<ul style="list-style-type: none">• Show Testpoint Window - open the Test Points window to manage, configure and run Test Points and associated Test Cases, Sets and Suites• Find Test Suites and Test Sets - search the current model for Test Suites, Test Sets and related elements used in managing Test Point based verification• Open Object Workbench - open a simple Object testing environment for Java and .Net; instantiate objects and dynamically call their methods
XSLT	Opens the XSLT Debugger, to debug an XSL Transformation.

Windows Panel

The 'Windows' panel provides access to a suite of windows associated with the debugging process, each of which provides information on an aspect of the application being debugged, particularly at a breakpoint.

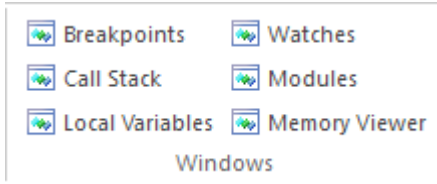

Available Facilities

Facility	Description
Breakpoints	Click on this icon to open the Breakpoints & Markers window, which you use to manage and configure source code breakpoints and other markers.
Call Stack	Click on this icon to open the Call Stack window, which displays all the currently-running threads in a process, at a breakpoint.
Local Variables	Click on this icon to open the Locals window, which displays the local application variables at a breakpoint.
Watches	Click on this icon to open the Watches window, which lists the customer variables by name when the application is at a breakpoint.
Modules	Click on this icon to open the Modules window, which lists the modules an application has loaded and is using at run time.
Memory Viewer	Click on this icon to open the Memory Viewer window to view a piece of memory when the application is paused at a breakpoint.

Source Panel

The 'Source' panel provides a set of buttons for building an application that is being analyzed. The active Analyzer Script defines the behavior of the Analyze tools, by specifying the commands that are executed and the settings and parameters for those commands. After making modifications to the code base, you can simply click on 'Build'.

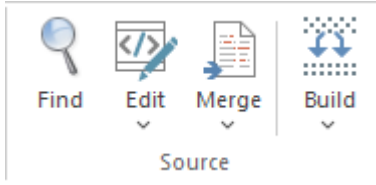

Available Facilities

Facility	Description
Find	Open the Find in Files window to search the local file system for source files that contain particular text.
Edit	<p>This icon provides a collection of tools for viewing and editing source code files associated with elements in the current model. Also provided are tools that generate source code for a particular element or synchronize an element to reflect changes in its associated source code file.</p> <ul style="list-style-type: none"> • Open Source File - display a 'File Chooser' dialog to browse for a source code file to open in the code editor window • Search in Files - display the 'Find in Files window, to locate files of a selected type containing a specified code string • Edit Element Source - open the code editor window and load the source code file associated with the currently selected element • Edit New Source File - create and populate a new source code file • Open in External Editor - launch the configured External Editor and load the source code file associated with the currently selected element
Merge	<p>Click on this option to display a short menu of user-defined commands defined in the currently active Analyzer script, to integrate with your source Version Control provider. Click on the command type to execute the command and perform the defined operation:</p> <ul style="list-style-type: none"> • Merge • Changes • History • Commit • Working Copy • Repository <p>If a command has not been defined, the option is grayed out.</p>
Build	<p>Click on the drop-down arrow to display a short menu of commands for building application source code:</p> <ul style="list-style-type: none"> • Build - build the current application, according to the currently active Analyzer script

	<ul style="list-style-type: none">• Deploy - execute the 'Deploy' command of the selected script.• Clean - run the Analyzer Clean command to delete intermediate files from the current application• Rebuild - run the Analyzer Clean and Build commands as defined in the currently active Analyzer script• Cancel Build - cancel the currently executing build
--	---

Run Panel

The 'Run' panel provides a set of buttons for building and running an application that is being analyzed. After making modifications to the code base, you can simply click on 'Build', then click on buttons to begin execution of the updated application, pausing or stepping through code as required. The active Analyzer Script will determine the behavior of the debugger tools, by specifying the commands that are executed as well as the settings and parameters for those commands.

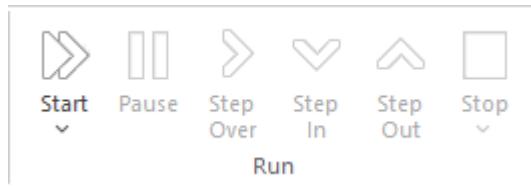

Available Facilities

Facility	Description
Start	<p>Click on the drop-down arrow to display a short menu of commands:</p> <ul style="list-style-type: none"> • Debug - start the application, according to the debug options of the active Analyzer Script • Run - resume execution of the application process that is currently being debugged - if no process is currently being debugged, then start the application specified in the debug options of the active Analyzer Script and attach the Debugger to that application process • Attach to Process - display a list of executing processes, select and attach to a process for the purpose of debugging • Test - execute the Test command configured in the current Analyzer Script • Show Execution Point - display and highlight the line of source code that corresponds to the current execution point
Pause	Pause execution of the application being debugged.
Step Over	Execute the next line of source code, without pausing inside any methods called by that line. The execution point will move to the next source line in the current context.
Step In	Execute the next line of source code, stepping into any method that is called. Execution is paused before executing the first executable line in the called method. If source code for the called method is not available, the debugger will return immediately to the calling code.
Step Out	Automatically run to the end of the current context/method and return to the calling context. Execution will pause again, upon return to the calling context.
Stop	Clicking on the drop-down arrow displays a short menu providing options to terminate debugging the application.

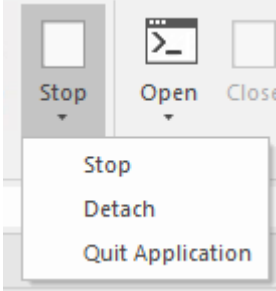
	 <ul style="list-style-type: none">• Stop - stops the Debugger and stops the process that is being debugged (the default when you just click on the ribbon icon)• Detach - stops the Debugger but leaves the process running• Quit Application - stops the Debugger and posts a WM_QUIT message to the main window of the process, if it has one
--	---

Construct Ribbon

The 'Construct' ribbon presents the tools and facilities for visualizing and managing the tasks and the resources needed to construct a system, from the allocation of human resources to tasks, to the Kanban boards and Gantt chart for visualizing the progress of work done. Teams can collaborate directly in the tool and manage a wide range of variations to model elements - including Issues and Defects - and tests can be defined and results recorded.

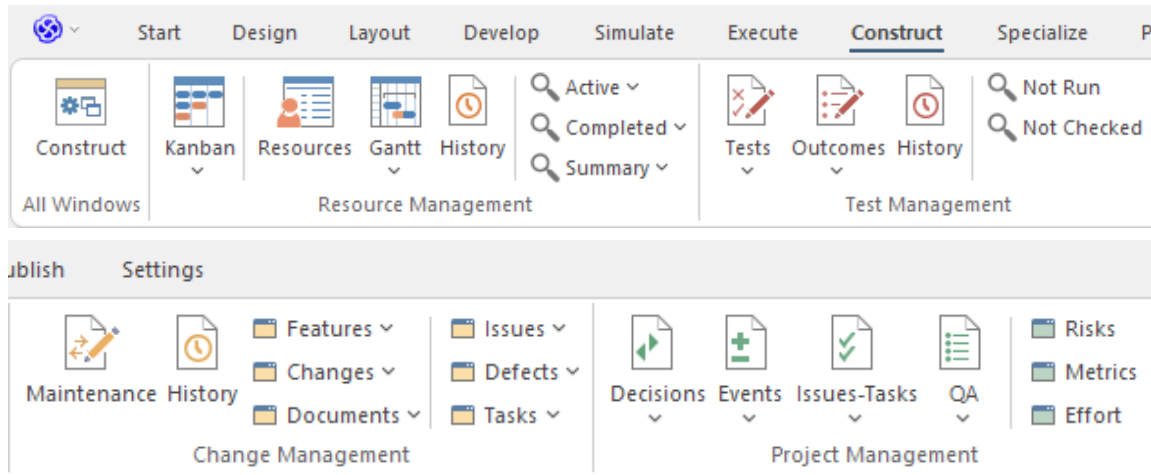

Panels

Panel	Description
All Windows	You can use the 'All Windows' panel to access a range of Window Selectors to select and open a window or a workspace.
Resource Management	The 'Resource Management' panel is a collection of tools for managing human resources and their allocation to elements that represent tasks to be completed. Kanban diagrams can be used to visualize boards of elements and Gantt charts show the duration of assigned tasks and other important views. The Resource Allocation window is used to assign resources to elements representing work to be done. There are several searches that list a variety of useful views, such as Overdue Tasks, Tasks Starting Today, and more.
Test Management	The 'Test Management' panel is used for creating and managing all aspects of testing. The Test Cases window conveniently collects all the tests for an element, and allows new tests to be created and existing ones to be managed. The tests can be fully described and Inputs, Acceptance Criteria, Results, Status and more can be defined for each test. There are several predefined searches that can be run to find recent test results, such as recent tests that have passed. A configurable Test Report can also be generated, creating a single document that describes all tests or any combination of tests.
Change Management	The 'Change Management' panel is used for define and record important items that apply to an element. Enterprise Architect is a platform for managing any initiative and can keep track of variations in the life time of any element. Regardless of the methods or processes that are being used, elements such as Requirements, User Stories, Business Rules, Components and others will change, have issues, require tasks and have defects. All of these variations can be created and managed and a series of useful searches are conveniently made available to find items such as recently requested changes, incomplete tasks and many more.

Project Management	The 'Project Management' panel provides facilities for managing project-level items such as issues, events, tasks and decisions, for defining project risks, effort and metrics, and for obtaining an overview of the project status, including Quality Assurance reports and project statistics.
--------------------	---

All Windows Panel

You can use the 'All Windows' panel to access a range of Window Selectors to select and open a window or a workspace.

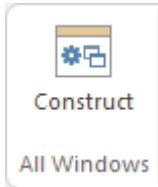

Available Facilities

Facility	Description
Construct	Click on this icon to display the Construct Window Selector. The Construct Window Selector gives access to tools for managing resources, changes, testing and project metrics. Click on the name of the required window to immediately open it.

Resource Management Panel

The 'Resource Management' panel is a collection of tools for managing human resources and their allocation to elements that represent tasks to be completed. Kanban diagrams can be used to visualize boards of elements, and a Gantt chart shows the duration of assigned tasks and other important views. The Allocation window is used to assign resources to elements representing work to be done. There are several searches that list a variety of useful views, such as Overdue Tasks, Tasks Starting Today, and more.

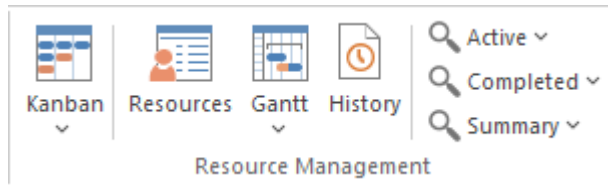

Available Facilities

Facility	Description
Kanban	<p>Click on the drop-down arrow to display a list of options for using Kanban diagrams to effectively manage tasks and work assignments necessary to construct the model and its deployable artifacts.</p> <ul style="list-style-type: none"> • Find Kanban Diagrams - open the 'Find in Project' tab containing an executed search for finding Kanban diagrams in the model; double-click on an entry to open that Kanban diagram • Open My Kanban - if a Kanban diagram has been set up with your work assignments and tasks, open that diagram • Manage - (for user settings) provides these options: <ul style="list-style-type: none"> - Set Current as Default - set the currently-open Kanban diagram as your user default - Choose Default - display a browser through which you locate and select a Kanban diagram to be your user default (you can also select <none> to clear the setting) - Clear - clear the setting of the user default Kanban so that there is no user Kanban defined • Open Project Kanban - if a Kanban diagram has been set up with the work assignments and tasks for the overall project, open that diagram • Manage - (for model settings) provides these options: <ul style="list-style-type: none"> - Set Current as Default - set the currently-open Kanban diagram as the Model or Project Kanban diagram - Choose Default - display a browser through which you locate and select a Kanban diagram to be your Model or Project Kanban diagram (you can also select <none> to clear the setting) - Clear - clear the setting of the model default Kanban so that there is no model Kanban defined • New Standard Kanban - create a new standard Kanban diagram to contain active work assignments and tasks, which you can customize as required • New Backlog Kanban - create a new Kanban diagram to contain work assignments and tasks that have not yet been allocated to a resource • New Iteration Kanban - create a new Kanban diagram to contain active work

	<p>assignments and tasks associated with the current iteration or sprint</p> <ul style="list-style-type: none"> • New Complete Kanban - create a new Kanban diagram to contain work assignments and tasks that have been completed and are processing through to deployment and maintenance • One Stage Workflow - create a single-stage Kanban workflow diagram from a Pattern • Two Stage Workflow - create a two-stage Kanban workflow diagram from a Pattern, including a Backlog Kanban and an Iteration Kanban • Three Stage Workflow - create a three-stage Kanban workflow diagram from a Pattern, including a Backlog Kanban, an Iteration Kanban and a Complete Kanban
Resources	<p>Click on this icon to display the Resource Allocation window to assign resources to Task, Issue, Change and other project-level elements.</p>
Gantt	<p>Click on this icon to list options to display:</p> <ul style="list-style-type: none"> • Your personal Gantt view, showing the breakdown of work specifically assigned to you • The Project Gantt View, to review the breakdown of work for the project and for specific sections of the project; the display defaults to the 'Resource View' tab, but you can also select the 'Element View' and 'Report View' tabs
Active	<p>Click on this icon to display a short menu of options for searching for and charting tasks within the model.</p> <ul style="list-style-type: none"> • Active Tasks - open the Find in Project view and execute a pre-loaded search for Active tasks; click on an item to display the resource allocation details in the 'Assigned Resources' dialog • Chart of Active Tasks - create a Chart within the selected open diagram showing the currently active tasks • Tasks Ending Today - open the Find in Project view and execute a pre-loaded search for tasks scheduled to complete today • Tasks Starting Today - open the Find in Project view and execute a pre-loaded search for tasks scheduled to begin today • Overdue Tasks - open the Find in Project view and execute a pre-loaded search for tasks that are now overdue • Chart of Overdue Tasks - create a Chart within the selected open diagram showing the currently overdue tasks
Completed	<p>Click on this icon to display a short menu of options for searching for and charting completed tasks within the model.</p> <ul style="list-style-type: none"> • Recently Completed - open the Find in Project view and execute a pre-loaded search for recently-completed tasks; click on an item to display the resource allocation details in the 'Assigned Resources' dialog • Chart of Completed Tasks - create a Chart within the currently-active diagram showing the recently-completed tasks • Chart for Time Period - create a Chart within the currently-active diagram showing the tasks completed during a defined period • All Completed - open the Find in Project view and execute a pre-loaded search for all tasks completed within the lifetime of the project
Summary	<p>Click on this icon to display a menu of options for searching for and charting the deployment of resources over various periods of time.</p> <ul style="list-style-type: none"> • 30 Day Task Summary (Brief) - provide a brief summary of the tasks

	<p>performed by resources over the previous month</p> <ul style="list-style-type: none">• 30 Day Task Summary (Full) - provide a full summary of the tasks performed by resources over the previous month• 30 Day Resources - search the project for tasks that have started in the last 30 days where the resource name matches (fully or partially) the text in the <Search Term>• 30 Day Roles - search the project for tasks that have started in the last 30 days where the role name matches (fully or partially) the text in the <Search Term>• 30 days grouped by resource (Chart) - create a chart within the currently-active diagram showing the tasks started during the last month, grouped by resource• 30 Day Task Summary (Chart) - create a chart within the currently-active diagram showing the tasks started during the last month
--	--

Test Management Panel

The 'Test Management' panel is used for creating and managing all aspects of testing. The Test Cases window conveniently collects all the tests for an element, and allows new tests to be created and existing ones to be managed. The tests can be fully described and Inputs, Acceptance Criteria, Results, Status and more can be defined for each test. There are several predefined searches that can be run to find recent test results, such as the recent tests that have passed. A configurable Test Report can also be generated, creating a single document that describes all tests or any combination of tests.

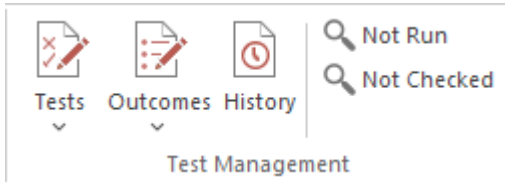

Available Facilities

Facility	Description
Tests	<p>Click on this icon to display a menu of types of Test that you can define for the current element, using the Test Cases window.</p> <ul style="list-style-type: none"> • All - display the Test Cases window listing tests of any class; you might select this option if you are developing a test but not yet certain of what type it should be, or if you are creating a suite of tests of different types • Inspection - display the Test Cases window set to work on Inspection tests • Unit - display the Test Cases window set to work on Unit tests • Integration - display the Test Cases window set to work on Integration tests • System - display the Test Cases window set to work on System tests • Acceptance - display the Test Cases window set to work on Acceptance tests • Scenario - display the Test Cases window set to work on Scenario tests
Outcomes	<p>Click on this icon to display a list of options for generating reports on recently-performed tests, and to represent the results of those tests in various forms of chart.</p> <ul style="list-style-type: none"> • Recent Test Results - open the Find in Project view and execute a pre-loaded search for tests that have been run within the last 7 days • Tests on Recently Modified Elements - open the Find in Project view and execute a pre-loaded search for tests that have defined for recently-modified elements (defaulting to modification within the last 7 days) • Add Pie Chart - generate, in the currently-open diagram, a Pie Chart of the test status statistics from the last seven days, per status type • Add Bar Chart - generate, in the currently-open diagram, a vertical Bar Chart of the test status statistics from the last seven days, per status type • Test Results from last week - generate, in the current diagram, a horizontal, stacked Bar Chart showing the test status statistics for each day of the last week • Test Results from last 30 days - generate, in the currently-open diagram, a horizontal, stacked Bar Chart showing the test status statistics for each day of the last 30 days, the most recent date being at the bottom of the chart • Test Results weekly summary - generate, in the currently-open diagram, a

	<p>horizontal, stacked Bar Chart showing the test status statistics for each week of the current year</p> <ul style="list-style-type: none">• Recent Test Passes - open the Find in Project view and execute a pre-loaded search for tests that have been given a Pass status within the last 7 days• Recent Test Failures - open the Find in Project view and execute a pre-loaded search for tests that have been given a Fail status within the last 7 days• Recently Deferred Tests - open the Find in Project view and execute a pre-loaded search for tests that have been given a Deferred status within the last 7 days• Report - Click on this icon to display the 'Generate Test Documentation' dialog, which you use to generate a report on the test records of one or more test types lodged against the elements of the current Package.
Not Run	Click on this icon to open the Find in Project view and execute a pre-loaded search for tests that are currently open but have not been run within the last 7 days.
Not Checked	Click on this icon to open the Find in Project view and execute a pre-loaded search for tests that are currently open but have not been checked within the last 7 days.

Change Management Panel

The 'Change Management' panel is used for describing important model management items that apply to an element. Enterprise Architect is a platform for managing any initiative and can keep track of variations in the life time of any element. Regardless of the methods or processes that are being used, elements such as Requirements, User Stories, Business Rules and Components will change, have issues, require tasks and have defects. All of these variations can be recorded and managed, and a series of useful searches are conveniently made available to find items such as recently requested changes and incomplete tasks.

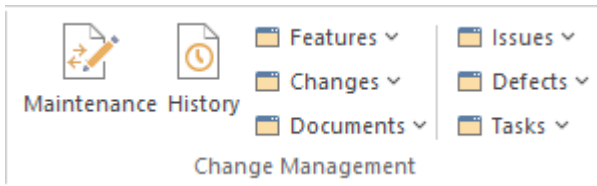

Available Facilities

Facility	Description
Maintenance	Click on this icon to display the Maintenance Overview tab of the Maintenance window, listing all the current Maintenance items on the selected element.
Features	<p>Click on the drop-down arrow to display a menu of options for performing searches manage and visualize records of features against elements in the model.</p> <ul style="list-style-type: none"> • Show Features Window - display the Features window, which you use to record and manage specific features of the selected element • New Features - open the Find in Project view and execute a pre-loaded search for elements that have new Feature items • Last Week - open the Find in Project view and execute a pre-loaded search for elements having Feature items that have been recorded within the last 7 days • Last Month - open the Find in Project view and execute a pre-loaded search for elements having Feature items that have been recorded within the last 30 days • Last 90 days - open the Find in Project view and execute a pre-loaded search for elements having Feature items that have been recorded within the last 90 days • Recently Completed Features - open the Find in Project view and execute a pre-loaded search for elements having Change items that have been completed within the last 7 days • Incomplete Features - open the Find in Project view and execute a pre-loaded search for Feature items that have not been completed
Changes	<p>Click on the drop-down arrow to display a menu of options for performing searches and generating charts to manage and visualize changes to elements in the model.</p> <ul style="list-style-type: none"> • Show Changes Window - display the Changes window, which you use to record and manage specific requests for changes to the selected element • New Changes - open the Find in Project view and execute a pre-loaded search for elements that have new Change items • Last Week - open the Find in Project view and execute a pre-loaded search for elements having Change items that have been recorded within the last 7 days • Last Month - open the Find in Project view and execute a pre-loaded search for elements having Change items that have been recorded within the last 30 days

	<ul style="list-style-type: none"> • Last 90 days - open the Find in Project view and execute a pre-loaded search for elements having Change items that have been recorded within the last 90 days • Chart Requested Changes - create a chart in the currently-open diagram, showing recently-requested changes • Recently Completed Changes - open the Find in Project view and execute a pre-loaded search for elements having Change items that have been completed within the last 7 days • Chart Completed Changes - create a chart in the currently-open diagram, showing recently-completed changes • Incomplete Changes - open the Find in Project view and execute a pre-loaded search for Change items that have not been completed
<p>Documents</p>	<p>Click on the drop-down arrow to display a menu of options for performing searches to manage and visualize records of documents opened against elements in the model.</p> <ul style="list-style-type: none"> • Show Documents Window - display the Documents window, which you use to record and manage specific documents of the selected element • New Documents - open the Find in Project view and execute a pre-loaded search for elements that have new document items • Last Week - open the Find in Project view and execute a pre-loaded search for elements having document items that have been recorded within the last 7 days • Last Month - open the Find in Project view and execute a pre-loaded search for elements having document items that have been recorded within the last 30 days • Last 90 days - open the Find in Project view and execute a pre-loaded search for elements having document items that have been recorded within the last 90 days • Recently Requested Documents - open the Find in Project view and execute a pre-loaded search for elements having document items that have been requested within the last 7 days • Recently Completed Documents - open the Find in Project view and execute a pre-loaded search for elements having document items that have been completed within the last 7 days • Incomplete Documents - open the Find in Project view and execute a pre-loaded search for Document items that have not been completed
<p>Issues</p>	<p>Click on the drop-down arrow to display a menu of options for performing searches and generating charts to manage and visualize records of issues raised against elements in the model.</p> <ul style="list-style-type: none"> • Show Issues Window - display the Issues window, which you use to record and manage specific reports of issues with the selected element • New Issues - open the Find in Project view and execute a pre-loaded search for elements that have new Issue items • Last Week - open the Find in Project view and execute a pre-loaded search for elements having Issue items that have been recorded within the last 7 days • Last Month - open the Find in Project view and execute a pre-loaded search for elements having Issue items that have been recorded within the last 30 days • Last 90 days - open the Find in Project view and execute a pre-loaded search for elements having Issue items that have been recorded within the last 90 days • Recently Reported Issues - open the Find in Project view and execute a pre-loaded search for elements having Issue items that have been recorded within the last 7 days

	<ul style="list-style-type: none"> • Chart Reported Issues - create a chart in the currently-open diagram, showing recently-reported Issue items • Recently Resolved Issues - open the Find in Project view and execute a pre-loaded search for elements having Issue items that have been resolved within the last 7 days • Chart Resolved Issues - create a chart in the currently-open diagram, showing recently-resolved Issue items • Unresolved Issues - open the Find in Project view and execute a pre-loaded search for Issue items that have not been resolved
<p>Defects</p>	<p>Click on the drop-down arrow to display a menu of options for performing searches and generating charts to manage and visualize records of defects raised against elements in the model.</p> <ul style="list-style-type: none"> • Show Defects Window - display the Defects window, which you use to record and manage specific reports of defects in the selected element • New Defects - open the Find in Project view and execute a pre-loaded search for elements that have new Defect items • Last Week - open the Find in Project view and execute a pre-loaded search for elements having defect items that have been recorded within the last 7 days • Last Month - open the Find in Project view and execute a pre-loaded search for elements having defect items that have been recorded within the last 30 days • Last 90 days - open the Find in Project view and execute a pre-loaded search for elements having defect items that have been recorded within the last 90 days • Recently Reported Defects - open the Find in Project view and execute a pre-loaded search for elements having Defect items that have been recorded within the last 7 days • Chart Reported Defects - create a chart in the currently-open diagram, showing recently-reported Defect items • Recently Resolved Defects - open the Find in Project view and execute a pre-loaded search for elements having Defect items that have been resolved within the last 7 days • Chart Resolved Defects - create a chart in the currently-open diagram, showing recently-resolved Defect items • Unresolved Defects - open the Find in Project view and execute a pre-loaded search for Defect items that have not been resolved
<p>Tasks</p>	<p>Click on the drop-down arrow to display a menu of options for performing searches and generating charts to manage and visualize records of tasks opened against elements in the model.</p> <ul style="list-style-type: none"> • Show Tasks Window - display the Tasks window, which you use to record and manage specific reports of tasks opened against the selected element • New Tasks - open the Find in Project view and execute a pre-loaded search for elements that have new tasks • Last Week - open the Find in Project view and execute a pre-loaded search for elements having task items that have been recorded within the last 7 days • Last Month - open the Find in Project view and execute a pre-loaded search for elements having task items that have been recorded within the last 30 days • Last 90 days - open the Find in Project view and execute a pre-loaded search for elements having task items that have been recorded within the last 90 days • Recently Requested Tasks - open the Find in Project view and execute a pre-loaded search for elements having tasks that have been recorded within the

	<p>last 7 days</p> <ul style="list-style-type: none">• Chart Requested Tasks - create a chart in the currently-open diagram, showing recently-requested tasks• Recently Completed Tasks - open the Find in Project view and execute a pre-loaded search for elements having tasks that have been completed within the last 7 days• Chart Completed Tasks - create a chart in the currently-open diagram, showing recently-completed tasks• Incomplete Tasks - open the Find in Project view and execute a pre-loaded search for tasks that have not been completed
--	---

Project Management Panel

The 'Project Management' panel provides facilities for managing project-level items such as issues, events, tasks and decision, for defining project risks, effort and metrics, and for obtaining an overview of the project status, including Quality Assurance reports and project statistics.

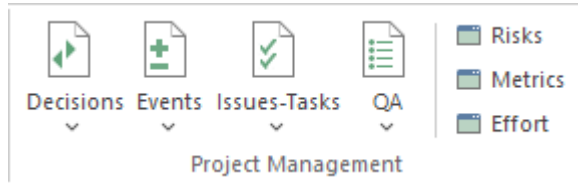

Available Facilities

Facility	Description
Decisions	<p>Click on the drop-down arrow to display a menu of options for performing searches and generating charts to manage and visualize records of decisions associated with elements in the model.</p> <ul style="list-style-type: none"> • Show Decisions Window - display the Decisions window, which you use to record and manage specific records of decisions associated with the selected element • Verified Decisions - open the Find in Project view and execute a pre-loaded search for elements having decisions with the status 'Verified' • New Decisions - open the Find in Project view and execute a pre-loaded search for elements that have new decisions • Recently Created Decisions - open the Find in Project view and execute a pre-loaded search for elements having decisions that have been recorded within the last 7 days • Chart Created Decisions - create a chart in the currently-open diagram, showing recently-created decisions • Recently Effective Decisions - open the Find in Project view and execute a pre-loaded search for elements having decisions for which the Effective date has passed within the last 7 days (that is, the decision has become effective) • Chart Effective Decisions - create a chart in the currently-open diagram, showing recently-effective decisions • Decisions with no Effective date - open the Find in Project view and execute a pre-loaded search for elements that have no Effective date recorded
Events	<p>Click on the drop-down arrow to display a menu of options for performing searches and generating charts to manage and visualize records of events reported against elements in the model.</p> <ul style="list-style-type: none"> • Show Events Window - display the Events window, which you use to record and manage specific reports of events lodged against the selected element • High Priority Events - open the Find in Project view and execute a pre-loaded search for elements that have events with the status High Priority • Recently Reported Events - open the Find in Project view and execute a pre-loaded search for elements having events that have been reported within the last 7 days • Chart Reported Events - create a chart in the currently-open diagram, showing recently-reported events

	<ul style="list-style-type: none"> Recently Completed Events - open the Find in Project view and execute a pre-loaded search for elements having events that have been marked as complete within the last 7 days Chart Completed Events - create a chart in the currently-open diagram, showing events that were recently marked as complete Open Events - open the Find in Project view and execute a pre-loaded search for events that are currently open
Issues-Tasks	<p>Click on the drop-down arrow to display two menu options:</p> <ul style="list-style-type: none"> Project Tasks - select this option to display the Project Tasks window, which provides a convenient 'To Do' list of major project work items that are not recorded elsewhere; it can be used to track events such as requests or corrections Project Issues - select this option to display the Project Issues window, on which you can record any identified issues against the current project
QA	<p>Click on this icon to display two options:</p> <ul style="list-style-type: none"> QA Reports Statistics <p>Select the first option 'QA Reports' to display the QA Reports view, which has separate tabs that enable you to run and display these system-provided status reports:</p> <ul style="list-style-type: none"> Testing Details Maintenance Details Dependency Details Implementation Details Use Case Metrics <p>Select the second option 'Statistics' to display the 'Project Statistics' sheet, which lists the numbers of Packages, diagrams, elements, connectors, elements of each type and element features of each type in the project. For certain items, such as element risks, metrics and effort, if there are no instances of that particular object type it is still listed but with a count of 0.</p>
Risks	<p>Click on this icon to display the Risks window, on which you create and maintain records of Risks to the work on the selected element.</p>
Metrics	<p>Click on this icon to display the Metrics window, on which you create and maintain records of metrics that have an influence on the work on an element.</p>
Effort	<p>Click on this icon to open the Effort window, on which you can create and maintain Effort records for the currently-selected element.</p>

Specialize Ribbon

The 'Specialize' ribbon provides facilities to enable and access Add-Ins (extensions written in COM) and MDG Technologies that interact with the Enterprise Architect user interface to extend and specialize the product's capabilities.

When an Add-In is added to Enterprise Architect, either by inclusion with the installer or by subsequently importing into Enterprise Architect, it can be assigned to the particular area of functionality that it supports (using the EA_GetRibbonCategory function), and is represented by an icon in an 'Add-In' panel in the appropriate ribbon. Icons for unassigned Add-Ins are shown on this 'Specialize' ribbon, in the 'Add-Ins' panel.

The contents of this ribbon therefore depend on what Add-Ins and Technologies you have installed and enabled, and whether they have been assigned to a particular functional area of Enterprise Architect.

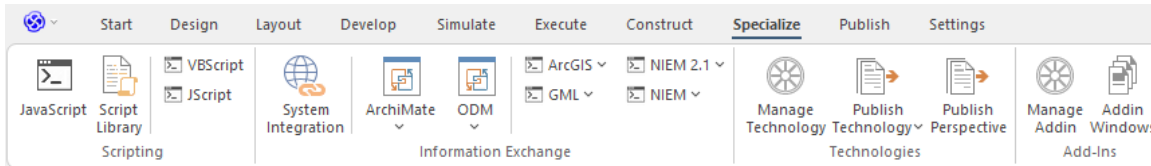

Panels

Panel	Description
Scripting	This panel provides access to the model Scripting window, which provides the means to manage, create and edit automation scripts to work with your model. It also provides icons that will open scripting consoles for each of the supported scripting languages.
Information Exchange	This panel provides access to external data sources through the Cloud Server. Click on the 'System Integration' icon to display the 'External Data' window to access external data sources through the Cloud Server. It also provides an icon for each enabled MDG Technology available in your installation of Enterprise Architect. Each Technology icon displays a drop-down list of options for working with the Technology.
Technologies	This panel provides the icons for managing and publishing MDG Technologies in Enterprise Architect Click on the 'Manage Technology' icon to open the 'MDG Technologies' dialog. This dialog helps you to add and configure paths to additional technology files and to activate or deactivate the built-in technologies. Click on the 'Publish Technology' icon to access options for working with MDG Technologies in general. Click on 'Publish Perspective' to publish a Model Perspective.
Add-Ins	This panel provides two icons for enabling and configuring Add-Ins: <ul style="list-style-type: none"> Manage Addin - display the 'Manage Add-Ins' dialog, which you use to enable or disable Add-Ins for use; an Add-In that is disabled is not loaded when you start up Enterprise Architect, and no icon appears for it in the ribbons Addin Windows - display the Add-In window containing any window that has been defined to display in this space, for the currently active Add-In If your system includes unassigned Add-Ins, an icon for each one is also included in this panel.

Scripting Panel

The 'Scripting' panel provides access to the model Scripting window, which provides the means to manage, create and edit automation scripts to work with your model. It also provides icons that will open scripting consoles for each of the supported scripting languages.

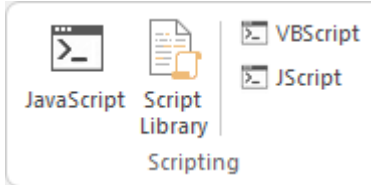

Available Facilities

Facility	Description
JavaScript	Click on this icon to display the JavaScript console, a command line interpreter that accepts single line JavaScript commands that will be executed one at a time.
Script Library	Click on this icon to display the Scripting window, through which you can add, edit and manage model-based scripts in JavaScript, JScript and VB.Net.
VBScript	Click on this icon to display the VBScript console, a command line interpreter that accepts single line VBScript commands that will be executed one at a time.
JScript	Click on this icon to display the JScript console, a command line interpreter that accepts single line JScript commands that will be executed one at a time.

Information Exchange Panel

The 'Information Exchange' panel provides an icon for displaying the 'External Data' window, through which you gain access to external data sources via the Cloud Server.

It also provides an icon for each enabled MDG Technology available in your installation of Enterprise Architect. This topic identifies some of the Technologies that might be represented here. Each Technology icon displays a drop-down list of options for working with the Technology. These options might include:

- Help - open the Help file for the Technology
- About - display a short panel of information on your installation of the Add-In
- Connect to External Model - connect to a project created in another application, to which the Technology provides a bridge
- Import <data> - import data defined in the Technology into Enterprise Architect
- Export <data> - export data from Enterprise Architect to data structures specific to the Technology

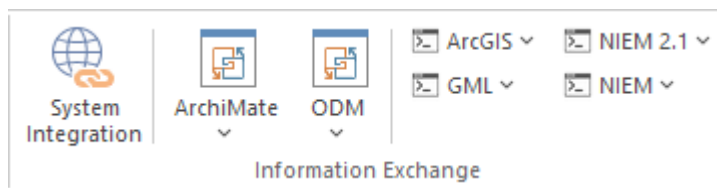

Available Facilities

Not all of these Technologies will be shown, and others might be available in the panel.

Facility	Description
System Integration	This icon opens the External Data facility for defining how the data from external sources is represented in Enterprise Architect. When developing a model in Enterprise Architect you could connect to an external application such as TFS or JIRA as the data source. You would then indicate how data items in one application are reflected in the other. Subsequently, you can check the pairings of data items from separate external tools, using the 'Show All Linked Items' menu option.
ArchiMate	Provides access to the facilities of ArchiMate 3, one of the business modeling tools integrated with Enterprise Architect. It offers a common language for describing the construction and operation of business processes, which you can use to describe, analyze and visualize clearly the relationships between business domains.
ODM	Provides access to the facilities of the Object Management Group's Ontology Definition Metamodel (ODM) for Enterprise Architect, with ontology modeling capabilities that enable you to develop large-scale ontologies within the fully-integrated modeling environment, for your project domain.
ArcGIS	Provides access to facilities that help you create ArcGIS models; the ArcGIS system supports the development and management of geodatabases.
GML	Provides access to the facilities of Enterprise Architect's integration with the Open Geospatial Consortium's Geography Markup Language (GML) 3.3 application schemas, providing an XML grammar for geographical feature modeling capabilities.

NIEM 2.1	Provides access to the facilities of the National Information Exchange Model (NIEM) release 2.1 in Enterprise Architect, which provides a common framework that is used to define how information can be shared between systems, government agencies and organizations.
NIEM	Provides access to the facilities of National Information Exchange Model (NIEM), releases greater than 2.1, in Enterprise Architect.
Eclipse	<p>The MDG Link™ for Eclipse is designed to support simultaneous UML development in both Enterprise Architect and Eclipse, adding extra functionality to the code generation abilities of Enterprise Architect and merging the changes with minimal effort. Click on the icon to display a short menu of options for using the Add-In.</p> <ul style="list-style-type: none"> • View Project Connections - display the 'Eclipse Connections' dialog, to review the connections between Enterprise Architect Packages and Eclipse Projects • Options - display the 'Options' dialog on which you set up the Eclipse installation path for Enterprise Architect to use to access Eclipse • Help - open the integrated Help for the MDG Link for Eclipse • About - display a panel of information on your installation of the MDG Link for Eclipse
Visual Studio	<p>The MDG Link™ for Visual Studio.NET is designed to support simultaneous UML development in both Enterprise Architect and Visual Studio, adding extra functionality to the code generation abilities of Enterprise Architect and merging the changes with minimal effort. Click on the icon to display a short menu of options for using the Add-In.</p> <ul style="list-style-type: none"> • View Project Connections - display the 'Visual Studio Connections' dialog, to review the connections between Enterprise Architect Packages and Visual Studio Projects • MDG Options - display the 'MDG Link Options' dialog to set or cancel Enterprise Architect as the tool for editing source code, and to automatically check for changes on merge (or not) • Import Build Scripts - import build scripts into Enterprise Architect from Visual Studio • Export Linked Package List - export a linked-Package list from Enterprise Architect into Visual Studio • Import Linked Package List - import a linked-Package list into Enterprise Architect from Visual Studio • Help - open the integrated Help for the MDG Link for Visual Studio • About - display a panel of information on your installation of the MDG Link for Visual Studio

Technologies Panel

The 'Technologies' panel provides the icons for managing and publishing MDG Technologies in Enterprise Architect

Click on the 'Manage Technology' icon to open the 'MDG Technologies' dialog. This dialog helps you to add and configure paths to additional technology files and to activate or deactivate the built-in technologies.

Click on the 'Publish Technology' icon to access options for working with MDG Technologies in general.

Click on the 'Publish Perspective' icon to publish a Model Perspective.

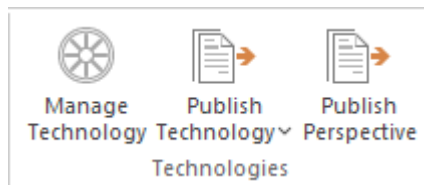

Available Facilities

Facility	Description
Manage Technology	Click on the 'Manage Technology' icon to open the 'MDG Technologies' dialog. This dialog helps you to add and configure paths to additional technology files and to activate or deactivate the built-in technologies.
Publish Technology	Click on the 'Publish Technology' icon to access these options for working with MDG Technologies in general: <ul style="list-style-type: none"> • Publish Diagram as Pattern - create a Pattern file from the currently-open diagram, using the 'Save Diagram as Pattern' dialog • Publish Diagram as UML Profile - create and export a Profile file based on the currently-open diagram, using the 'Save UML Profile' dialog • Publish Package as UML Profile - create and export a Profile file based on the current Package, using the 'Save UML Profile' dialog • Generate MDG Technology - open the MDG Technology Creation Wizard to guide you through the process of creating and integrating the structures and resources appropriate to an MDG Technology of your own design • Import MDG Technology - import an MDG Technology into the model either for your own use or for all users of the model; the 'Import MDG Technology' dialog displays • Import Package as UML Profile - generate a UML Profile from the selected <<profile>>package and import it into the current model as an MDG Technology • Import Package as MDG Technology - generate an MDG Technology from the selected <<mdg technology>> package and any <<profile>>, <<toolbox profile>> and <<diagram profile>> packages that it owns, and import it into the current model
Publish Perspective	Click on the 'Publish Perspective' icon to open the Perspective Sets dialog.

Add-Ins Panel

The 'Add-Ins' panel provides the facilities for enabling Add-Ins and displaying any windows that they define. The panel also provides icons to access unassigned Add-Ins.

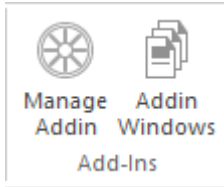

Available Facilities

Facility	Description
Manage Addin	Displays the 'Manage Add-Ins' dialog, which you use to enable or disable Add-Ins for use; an Add-In that is disabled is not loaded when you start up Enterprise Architect, and no icon appears for it in the ribbons.
Addin Windows	Displays the Add-In window, which contains any window that has been defined to display in this space, for the currently active Add-In.
<unassigned Add-Ins>	An Add-In that is not assigned to an 'Add-Ins' panel in a specific ribbon will have an icon in this 'Specialize > Add-Ins' ribbon panel.

Publish Ribbon

The 'Publish' ribbon brings together all the tools for publishing, documenting and importing and exporting valuable model assets in a wide range of formats and styles, ranging from publications for corporate audiences to spreadsheets, XML schemas, Patterns, Reusable Assets and much more. The model is the repository of valuable organizational information and knowledge, and people who don't access the model directly can still get access to this knowledge through this panel of tools.

The publishing system provides a great deal of flexibility, and outputs and inputs can be tailored to exactly what an audience requires. This includes the flexible Documentation engine, with its in-built and user defined templates and styles that can produce high quality corporate publications directly from the model. Elements and diagrams can be imported and exported, including exchanging information with spreadsheet tools and saving to reusable Patterns and assets.

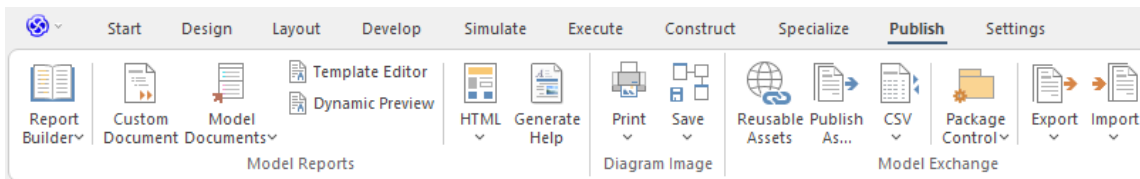

Panels

Panel	Description
Model Reports	The 'Model Reports' panel groups together a set of tools used to extract information from the model in a variety of useful formats, including customized documents and templates, Model Documents, docx, pdf and HTML.
Diagram Image	The 'Diagram Image' panel provides facilities to generate both hard and electronic copies of diagrams from the model, and to scale images of the diagrams when they are generated.
Model Exchange	<p>The 'Model Exchange' panel contains tools for controlling Packages and importing and exporting parts of the model in the XML based model exchange format XML, and to formats that can be opened in a spreadsheet. The Reusable Asset Server (RAS) is a valuable resource for either sourcing existing model fragments or saving parts of the current model for reuse on future initiatives.</p> <p>The panel also provides options that enable you to generate files from the Enterprise Architect model in a format that can be used specifically in one of a range of supported technologies, and to import files from the same range of technologies and convert them for use in Enterprise Architect.</p>

Model Reports Panel

The 'Model Reports' panel provides a set of tools for extracting information from the model for output in a variety of useful formats, including DOCX, PDF and HTML.

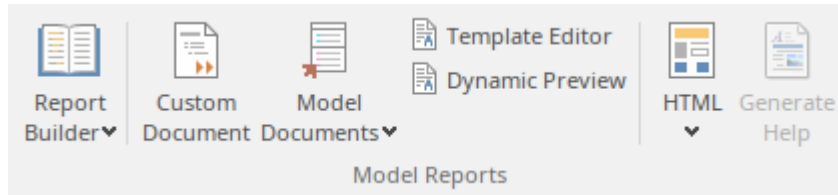

Available Facilities

Facility	Description
Report Builder	<p>Click on this icon to access a short menu of documentation options:</p> <ul style="list-style-type: none"> • Generate Documentation - generate a document from the content of the model; generate rtf, pdf or docx format, from built-in or customized templates • Generate Documentation from Selected Objects - generate a document from a selection of objects (Ctrl+click on each) in the Browser window or in a diagram • Simple Diagram Report - generate a 'Diagram Only' report to capture images of all diagrams in the current Package - the 'Generate Documentation' dialog displays, defaulted to a Diagram Report template; specify the 'Output to File' path, including the file extension to set the file format • Open a Document File - open an existing document file in RTF or DOCX format, for manual editing • Create a New Document File - create a new document for manual editing and export it in RTF or DOCX format
Custom Document	<p>Click on this icon to start to generate a custom linked document, which can contain any of a range of document objects from the model, each formatted with their own document templates.</p>
Model Documents	<p>Click on this icon to access a short menu of Model Document options:</p> <ul style="list-style-type: none"> • New - create a new Model Document element using the 'New Element' dialog; the 'Toolset' and 'Type' fields default to the values for creating a Model Document element • New from Pattern - create the Model Document from a base pattern, using the 'Create from Pattern' tab of the Start Page; the tab defaults to the Document Publishing perspective, and you can select the appropriate pattern from the list • Find Model Documents - run a search in the Find in Project view, to locate all Model Documents existing in the model; you can use the context menu options to operate on one or more elements, including generating a documentation report • Find Document Packages - run a search in the Find in Project view, to locate all Packages with the stereotypes 'Master Document' or 'Report Package', which are designed to contain Model Document elements; again, you can select context menu options to generate documentation from the contents of one or more Packages • Help - select this option to display the <i>Model Documents</i> Help topic

Template Editor	Click on this icon to manage, create and modify the templates used in generating documents in RTF, PDF or DOCX format.
Dynamic Preview	Click on this icon to display the Dynamic Preview window, which displays a document instantly generated from the current element.
HTML	Click on this icon to select from two options for publishing documents on the web: <ul style="list-style-type: none">• Standard HTML Report - publish a document to an internal or internet website as static web pages, in standard HTML• Publish to Joomla! - generate an HTML document to a Joomla! database, for internet distribution
Generate Help	Click on this icon to display the <i>Generate Help</i> dialog. From the <i>Generate Help</i> dialog, you can specify generation templates, output folders and other options for generating HTML pages, suitable for use on a web site. This icon is enabled when a package with the stereotype <<HelpPackage>> or a class with the stereotype <<HelpTopic>> is selected in the Browser window.

Diagram Image Panel

The 'Diagram Image' panel provides facilities to generate both hard and electronic copies of the currently-open and selected diagram from the model.

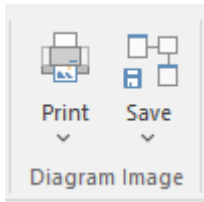

Available Facilities

Facility	Description
Print	<p>Click on this icon to display a short menu of options for printing the diagram:</p> <ul style="list-style-type: none"> • Print - print the diagram directly on the default printer • Preview - display an image of how the diagram will appear if it is printed • Setup - display the 'Print Setup' dialog to configure the default printer on which the diagram will be printed, which you would have selected on the Windows 'Control' panel • Print to PDF - print the diagram to a PDF file instead of to a printer - a browser displays to select the PDF file name and directory path; by de-selecting the 'Printable' option on an element on a diagram, you can omit that element and its connectors from the diagram in the PDF output
Save	<p>Click on this icon to save an image of the current diagram. A small menu displays from which you can select to:</p> <ul style="list-style-type: none"> • Save to File - a browser displays in which you select where to save the file, and the format in which to save the file • Save to Clipboard - the image is immediately saved to the Enterprise Architect clipboard • Scale Image - a list displays of percentage scale options from 100% to 400%, to apply to the diagram images saved to file <i>in bitmap format</i>, with a tick beside the current setting (likely to be the default of 137%); this list and the 'Scale Saved Bitmaps to' field on the 'Diagram' page of the 'Preferences' dialog are parallel and changes to one are automatically reflected in the other. Images saved in any format other than bitmap are not scaled. On the 'Diagram' page of the 'Preferences' dialog, selecting the 'Apply scale to clipboard' checkbox also applies the selected scale to bitmap images saved to the clipboard

Model Exchange Panel

The 'Model Exchange' Panel contains tools for controlling Packages and for importing and exporting parts of the model both in the XML-based model exchange format, and in other formats that can be opened in a spreadsheet. The Reusable Asset Server (RAS) is a valuable resource for either sourcing existing model fragments or saving parts of the current model for reuse on future initiatives.

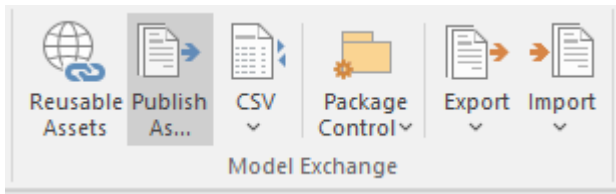

Available Facilities

Facility	Description
Reusable Assets	Click on this icon to open the Reusable Asset Service (RAS) view in the central work area. The RAS provides a simple and convenient mechanism for modelers to distribute or download reusable model structures, information, corporate directives and standards. The shared repository is accessible via a Pro Cloud Server connection, making it accessible for distributed teams.
Publish As...	Click on this icon to publish a Package at any level in the model as an external file in one of several XML formats, including XMI 1.1, XMI 2.1, Enterprise Architect's Native XML, ArcGIS and BPMN 2.0 XML. The 'Publish Model Package' dialog displays.
CSV	Click on this icon to access the CSV Import and Export facilities, and to create and maintain the CSV specifications that define how the imports and exports proceed. You can also display the summary Help topic for CSV transfers.
Package Control	Click on this icon to display a menu of options for storing and managing Packages by creating XMI files from them (Package Control), supporting lightweight version management and model exchange. <ul style="list-style-type: none"> Package Control - configure Package Control using the 'Package Control Options' dialog Save to File - save the Package to its configured XMI file (from the 'Package Control' option), using the 'Export to Native/XMI File' dialog Load from File - replace the Package from its saved XMI file, using the 'Import Package from Native/XM File' dialog View XMI File for Controlled Package - review the content of the (exported) XMI file for the Package, in the Code Editor Compare Package to XMI - compare the current version of the Package with the exported XMI file for the Package (the 'Compare Model to File' option in Managing Baselines)
Export	Click on this icon to display options for exporting the current Package to a Native File or XMI file for use in other models and/or different modeling tools. <ul style="list-style-type: none"> Native Format (or XMI Format) - export the Package to a file in one of several Native or XMI formats, using the 'Export to Native/XMI File' dialog

	<ul style="list-style-type: none"> • (Batch) Export Controlled Packages - export a number of controlled Packages to Native/XMI format in a batch process, using the 'Batch Export Controlled Packages' dialog <p>A range of other output formats is supported, and you can further tailor the output by including or excluding diagram information, Enterprise Architect specific extensions and so on. You would tailor your published file for the capabilities of the tool or process expected to consume it.</p> <p>The 'Normative XMI 2.4.2' option provides a quick means of exporting model information in the latest UML/XMI combination with no Enterprise Architect extension information or diagram information. This format is most useful for standards development and for base interoperability with other UML based tools.</p>
<p>Import</p>	<p>Click on this icon to display options for importing a Native/XMI file to update one or more Packages in the model.</p> <ul style="list-style-type: none"> • Native File, or XMI File - import a Package from a file in one of several Native/XMI formats, using the 'Import Package from Native/XMI File' dialog • Merge Model XML into Current Package - import an XML file for the Package and merge the content of the file with the Package; you might do this with a sequence of XML files for the Package, such as when a number of people are working on the same Package offline and storing their work in separate XML files • Batch Import Controlled Packages - import model Packages from an import set for controlled Packages, using the 'Batch Import Controlled Packages' dialog <p>The menu provides options for importing XMI/XML from a variety of other formats. ArcGIS, EMX/UML2, Rhapsody, OWL/RDF, BPMN 2.0, DMN 1.1 and MDZIP are specifically supported, but a range of other tools' XML output can be imported into Enterprise Architect using the 'Other Tools/Formats' menu option.</p>

Settings Ribbon

The 'Settings' ribbon is used for managing the way a repository is used, from setting up reference data, security and Version Control to audits and integrity checks. Enterprise Architect is a flexible platform and can be configured to suit any enterprise, business or technical team.

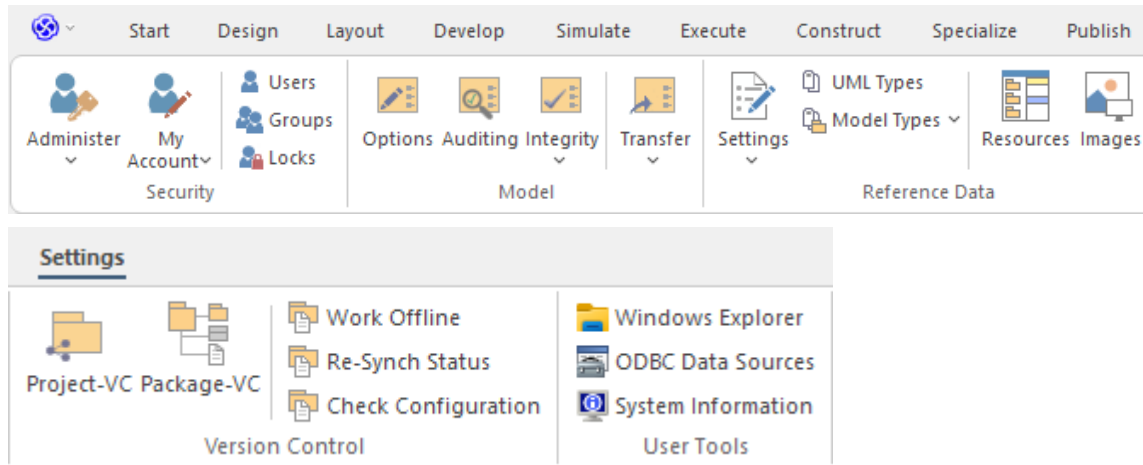

Panels

Panel	Description
Security	The 'Security' panel collects together a set of facilities for using and managing security in the model. Security helps teams collaborate by allowing individuals to intentionally signal that they are working on a part of the model.
Model	The 'Model' panel provides facilities to configure options for the current model, to check and repair the integrity of the model database, to transfer project data from one database to another and to configure auditing settings for recording changes to the model database.
Reference Data	The 'Reference Data' panel is used to set up and manage the metadata for a model. Reference Data is typically created when the model is initiated, but some of this data such as Resources and Images will be added to as the model evolves. There is a wide range of options, from setting up auto naming counters for elements, creating Stereotypes, Tagged Value Types and Cardinalities, to setting up people, Status, Priority and much more. Resources store a wide range of additional model content such as Templates, Profiles, Patterns and Relationship Matrices. Images can be saved in the model and used to replace the conventional geometric representations with descriptive and compelling images that resonate with non-technical audiences.
Version Control	The 'Version Control' panel is used for working with the Version Control facility in the tool, allowing you to manage changes and versions of model content for individual Packages or the entire model. Version Control Configurations can be defined using the 'Project-VC' or 'Package-VC' options, and checked for all versioned Packages using the 'Check Configuration' option. There is a range of options to view the history of changes and to revert the model to a previous version if desired. There are also options to work offline and to compare the status reported by the model and the Version Control provider.

User Tools	<p>The 'User Tools' panel provides access to a series of external tools useful to you while working on the model. Windows Explorer can be useful when working with importing and exporting content from the model, including CSV files for exchange with a spreadsheet tool, XML Schema files, Database and Source code files and the generation of Documentation. Open Database Connectivity (ODBC) settings can be accessed to assist when working with live databases, and system information can be viewed.</p>
------------	---

Security Panel

When Security is enabled on a project, users are required to provide a User ID and password to login to that project. Project Security helps teams to collaborate by allowing individuals or groups to intentionally signal that they are working on specific parts of the model.

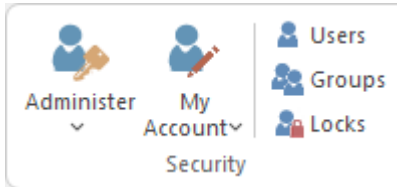

Available Facilities

The 'Security' panel collects together a set of facilities for managing security in the model, such as enabling Project Security, specifying which security mode to use, defining the lists of authorized users and user groups, and assigning permissions to users and groups to grant access to various aspects of Enterprise Architect's functionality.

Facility	Description
Administer	<p>Click on the drop-down arrow to display a selection of commands for configuring security in the model.</p> <ul style="list-style-type: none"> Apply Locks to Connectors - extends all locks on source elements to the connectors owned by those elements, so that those connectors cannot be deleted and their properties cannot be edited; new connectors cannot be created on those elements Require User Lock to Edit - enables 'pessimistic' locking on the current project; in this mode, users must apply a personal lock to model elements and diagrams before any modifications can be made Group Workflow - select to set up the workflow from one status to another, for each security group Enable Security - toggles (either enable or disable) the state of Project Security for the current project; you are prompted to supply an Authorization Key before the security state is changed Show User Avatars - displays (or, if unselected, hides) all user avatars in Chat and Discussion entries, in your work sessions
My Account	<p>Click on the drop-down arrow to display a selection of commands for configuring security on your user ID.</p> <ul style="list-style-type: none"> Manage My Locks - displays a dialog that lists all locks you have applied under your user ID; you can review and release locks using this dialog Remember Me - when set, this stores your credentials and applies them automatically each time you log in Change Password - displays the 'Change Password' dialog in which you can change the password for your own, currently logged in, user ID Set Avatar - assigns an avatar image (from a selected Image Asset Artifact) to your user ID Hide OpenID login window - displays (unselected) or hides (selected) the 'OpenID Authentication' dialog; also resets the 'Don't show this window again' checkbox on the 'OpenID Authentication' dialog Login as Another User - displays the login dialog to enable you to log in to the Enterprise Architect project as another user

	(Some of these options are also available from the <user name> drop-down in the top right corner of the Enterprise Architect screen.)
Users	This command displays the 'Security Users' dialog, where new users can be defined and permissions can be granted to those users. Users can be added to existing User Groups. The dialog also provides for import of user definitions from Windows Active Directory lists.
Groups	This command displays the 'Security Groups' dialog, where new User Groups can be created and users can be added to those groups. Permissions can be granted to User Groups using this dialog.
Locks	This command displays the 'Manage Locks' dialog. The dialog shows a list of all elements and diagrams within the model that have active locks. You can also filter to show only items with User Locks or Group Locks. The list of items can be sorted by lock type, item name, locking user, locking group, or the time of lock application. The dialog can be used to select some or all of the locked items, and then to unlock the selected items.

Model Panel

The 'Model' panel provides facilities to configure options for the current model, to check and repair the integrity of the model database, to transfer project data from one database to another and to configure auditing settings for recording changes to the model database.

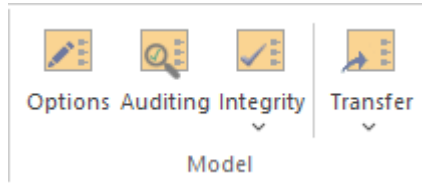

Available Facilities

Facility	Description
Options	Displays the 'Manage Model Options' dialog, through which you configure options for the current model, including required and restricted MDG Technologies, code generation and general options.
Auditing	Opens the Audit View to configure and view audit management information for the current model.
Integrity	<p>Occurrences such as network crashes or failed XMI imports can sometimes compromise the integrity of information in the model database. Clicking on the 'Integrity' drop-down arrow displays a list of commands for addressing these kinds of issue and for general database maintenance.</p> <ul style="list-style-type: none"> • Project Integrity - displays the 'Project Integrity Check' dialog; used for examining database records to check for 'orphaned' records or inaccurate or unset identifiers • Project Compare - displays the 'Project Compare' dialog, with which you can compare one model database against another, at a table record level • Manage .QEA/.QEAX File - clicking on this item displays a pop-up menu with these options: <ul style="list-style-type: none"> - Compact .QEA/.QEAX File - removes deleted records from the database tables - Compact .QEA/.QEAX File to new file - removes deleted records from the database tables and stores the compacted model to a new file • Manage .EAPX/.EAP File - clicking on this item displays a pop-up menu with these options: <ul style="list-style-type: none"> - Repair .EAPX/.EAP File - use this option to repair a .EAPX or .EAP file that has become damaged due to system or network outages - Compact .EAPX/.EAP File - removes deleted records from the database tables - Update .EAPX/.EAP File Indexes - updates the selected .EAPX or .EAP file to the latest set of indexes (schema 1558) • Manage Firebird <ul style="list-style-type: none"> - Update Index Statistics - optimize indexes on Firebird databases • Run Patch - displays the 'Run Patch' dialog, which provides a means to run patches that could be provided by Sparx Systems, to update the database structure of the current model

Transfer	<p>Clicking on the drop-down arrow displays a menu of facilities for copying or sharing project data between one project and another.</p> <ul style="list-style-type: none">• Full Project Transfer via Connection - display the 'Project Transfer' dialog; use this dialog to copy the tables and records of one project database to another• Full Project Transfer via Native XML - export or import a complete project in the native XML format• Migrate EAP/EAPX Project to QEA - migrate a complete project from an EAP or EAPX file to another repository• Copy QEA Project to Firebird (FEAP) - copy the project data from a .qea file (in Enterprise Architect release 16.0 upwards) to a legacy .FEAP file (for use in Release 15.2 or earlier)• Perform project file replication work on either a .eap project file or a .qea project file:<ul style="list-style-type: none">- Make Design Master - prepare a .EAPX/.EAP file or a .QEA file for the creation of database replicas- Create New Replica - create database replicas from the Design Master file- Synchronize Replicas - merge the changes made to each replica with the Design Master- Remove Replication - remove from the database the additional information that is required for managing database replication- Resolve Replication Conflicts - where two users have made conflicting changes to the model database, manually decide which change will override the other (not for QEA Replication)• Shared Repository - set up a shared repository for basic reference data to be shared between multiple implementation models• Export Reference Data - display the 'Export Reference Data' dialog; used to select specific types of Reference Data for export to an XML file• Import Reference Data - display the 'Import Reference Data' dialog; used to import Reference Data from an XML file into the current model
----------	---

Reference Data Panel

The 'Reference Data' panel is used to set up and manage the metadata for a model. Reference data such as Resources and Images is generally added as the model evolves. A wide range of additional model content such as Templates, Profiles, Patterns and Relationship Matrices can be stored as Resources. Images can be saved in the model and used as alternatives to the conventional geometric representations of elements, to appeal to non-technical audiences.

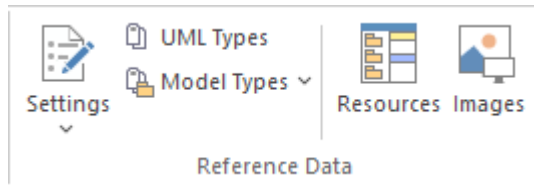

Available Facilities

Facility	Description
Settings	<p>Click on the drop down arrow to display a menu of options for setting a wide range of project-level parameters.</p> <ul style="list-style-type: none"> • Auto Names and Counters - set up and manage the use of automatic name generation • Project Template Package - specify a Package that holds diagrams and elements that will be used as templates for all new elements • Database Datatypes - manage the list of Datatypes that are used in Database Engineering • Namespace Roots - manage a list of Namespace roots for the current model; used mainly for code generation • Coding Datatypes - manage the list of Datatypes that are used in Code Engineering • Preprocessor Macros - manage a list of preprocessor macros that will be used when C and C++ code is imported into the model • Colors - provides options to define and manage a set of standard colors for use in the current project <ul style="list-style-type: none"> - Get Project Custom Colors - Set Project Custom Colors
UML Types	<p>Displays the 'UML Types' dialog, from which you can manage basic model information, such as Stereotypes, Tagged Value types and Cardinality settings.</p>
Model Types	<p>Provides a range of facilities for managing various Types of reference data used in a project.</p> <ul style="list-style-type: none"> • People - manage the list of people associated with the model, including authors, resources, roles and clients • General Types - manage project factors, such as Status types, Constraints, Difficulty and Priority • Project Indicators - configure indicators such as Metric, Risk and Effort types • Maintenance - define and manage Test types • Estimation Factors - set up and manage a list of estimation factors used for Use Case Estimation

Resources	Click on this icon to display the 'Resources' tab of the Browser window, from which you can manage a variety of custom resources, model Patterns, templates and technologies.
Images	Click on this icon to display the 'Image Manager' dialog. The Image Manager provides facilities for storing images in the current model, that can then be used as alternatives to the standard geometric shapes normally used to represent elements on your model diagrams. Stored images can be previewed, renamed and updated using this facility.

Version Control Panel

The 'Version Control' panel provides facilities for configuring and managing the Version Control facility in the tool. Version Control Configurations can be defined using the 'Project-VC' option and validated for all versioned Packages using the 'Check Configuration' option. There are options to work offline and also to compare the status recorded in the model against that reported by the Version Control provider.

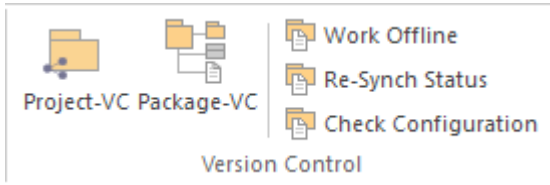

Available Facilities

Facility	Description
Project-VC	Displays the 'Version Control Settings' dialog, in which you can define new Version Control Configurations, or re-specify the Working Copy Folder of an existing Version Control Configuration.
Package-VC	Configure a single Package for Version Control. Display the 'Package Control Options' dialog to specify the Version Control Configuration and the name of the file to use in controlling the selected Package.
Work Offline	Toggles Version Control in and out of 'Offline' mode. The 'Offline' mode allows modelers to work with Version Controlled Packages, even when there is no connection to the Version Control server. Packages can be 'checked-out' offline and modified, but can only be 'checked-in' once a connection to the Version Control server has been re-established.
Re-Synch Status	Query the Version Control server to retrieve the check-out status of the file associated with each of the Version Controlled Packages in the current project. Where it is necessary and appropriate to do so, the status of the Package is updated in the project database to match the status reported by the Version Control system. For example, if a Package is marked in the project database as checked-out to the current user, but the Version Control server reports the associated file as not checked-out, then the Package flags will be updated to show 'not checked-out'.
Check Configuration	This command scans all Version Controlled Packages within a project, checking the validity of the Version Control settings for each Package. The validation process scans the model database and verifies that the Version Control Configuration associated with each Version Controlled Package is fully specified in the current model. It also queries the corresponding Version Control provider to find the status of the Package file associated with each Version Controlled Package. The results of the validation process are sent to the System Output window.

User Tools Panel

The 'User Tools' panel provides access to external tools. A pre-defined selection of tools includes Windows Explorer, ODBC Data Sources and System Information. You can extend this list with any other tools of your choice.

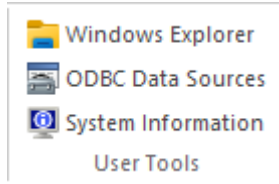

Available Facilities

Which user tools appear in the list depends on what has been configured on your workstation. For example, you might add 'WINE Console' for the purpose of setting up Subversion clients for Enterprise Architect under WINE.

Facility	Description
Windows Explorer	Launches 'Windows Explorer'.
ODBC Data Sources	Launches the 'ODBC Data Source Administrator' dialog, from which you can set up ODBC drivers for various DBMSs, thereby enabling Enterprise Architect to connect to repositories hosted in the selected DBMS.
System Information	Displays System Information pertaining to your personal workstation.

Specification - Specify Ribbon

The 'Specification - Specify' ribbon provides a selection of facilities that you might use when creating and editing model elements as a text-based specification, using the Specification Manager. The ribbon becomes available when the Specification Manager is open.

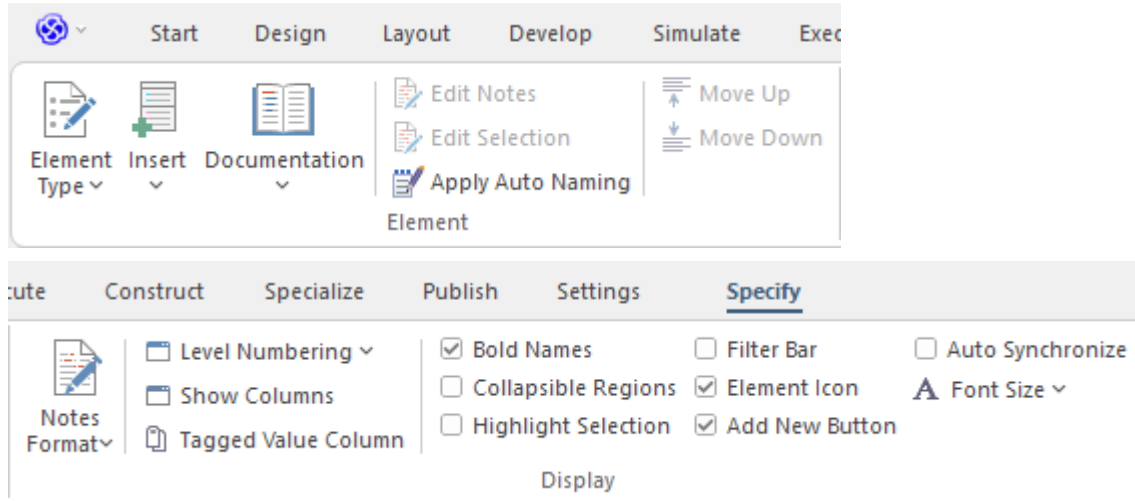

Panels

Panel	Description
Element	The 'Element' panel offers a range of facilities for working with the elements that are displayed in the Specification Manager view. There are facilities for adding new elements and viewing and editing element properties.
Display	The 'Display' panel provides a range of options that make it possible to tailor the appearance of the Specification Manager view, to better display the information you want to examine. There are options providing visual cues, such as highlighting the selected element and using bold fonts to emphasize element names, as well as options to filter the list of elements that are displayed.

Element Panel

The 'Element' panel brings together a range of facilities for working with the elements that are displayed in the Specification Manager view. There are facilities for adding new elements, and for viewing and editing the Properties of elements, as well as for generating documentation in a number of formats.

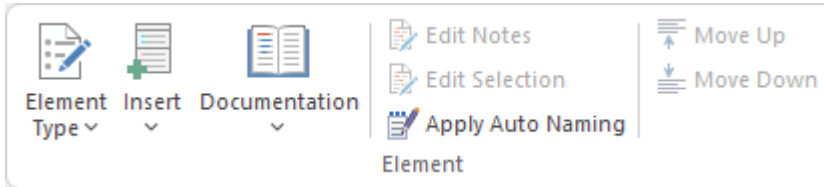

Available Facilities

Facility	Description
Element Type	<p>Click on the drop-down arrow to display a range of options for filtering the type of element created when you select to add a new element using the Specification Manager Add New button (not the drop-down arrow):</p> <ul style="list-style-type: none"> • <Any> - when selected, and when you click on the Add New button, the 'New Element' dialog displays from which you select the type of element to create • Other - displays the full list of work sets from which you select a specific element to add to the list in the <element types> section of the drop-down • <element types> - a list of element types that you have selected to create, using the 'Other' option; click on one of these, and every time you click on the Add New button an element of that type is created, until you specifically select a different type • Clear Recent Items - clears the <element types> list; a prompt displays to confirm the operation, as it can be a lengthy job to reconstruct the list of selected element types Note that if you have a specific element type selected, that type is not cleared from the list; selecting the <Any> option allows you to clear the final element type from the list • Use Last Created Type - sets the type of element created to the type of the last-created element • Limit Display to Selected Type - filters the Specification Manager display to only show elements of the selected type
Insert	<p>Click on the drop-down arrow to display a short menu of options for adding elements:</p> <ul style="list-style-type: none"> • Add Default - add a new element of the default element type, which is the currently-selected type of those set using the 'Element Type > Other' option. Alternatively, if no element type is selected, the 'New Element' dialog displays; use this to create an element, the type of which becomes the default type • Add Child - add a new element as a child of the currently selected element; if a default element type has been specified, an element of that type is created, otherwise the 'New Element' dialog is displayed, prompting you to choose a type • Repeat Previous - repeat the previous element insertion action, creating a new element of the same type, as a sibling to the previously inserted element • Show Toolbox - open and display the Diagram Toolbox showing the Common, Artifact and other 'pinned' pages, or switch focus to the currently opened

	<p>Toolbox; you can drag element icons from the Toobox to create elements in the Specification Manager, switching to other Toolbox pages if necessary</p> <ul style="list-style-type: none"> • Add Other - display the 'New Element' dialog, prompting you to choose an element type and create an element of that type • Add Multiple Elements - display the 'Create Multiple Elements' dialog, through which you can add several elements to the Specification Manager in one operation
Documentation	<p>Clicking on the drop-down arrow displays a list of commands for generating documentation and reports based on the current Package, in a range of different formats. Also available is a facility for spell-checking the notes of elements belonging to the current Package.</p> <ul style="list-style-type: none"> • Generate Documentation (RTF/PDF/DOCX) - displays the 'Generate Document' dialog, where you can specify a range of parameters and options that control generation of a report document; you can select document templates that control which elements are included in the report, choose from a range of cover pages and style sheets, and specify the file output path and file format • Publish as HTML - displays the 'Publish as HTML' dialog, from which you can create a report on the current Package for display as a web page; the dialog allows you to specify a range of parameters and options to control the report generation, such as style templates, diagram themes, image formats and the output file path name • Publish as Joomla! Article - opens the 'Publish as Joomla! Article' dialog; use this dialog to specify connection details for the Joomla! database, the content template and diagram theme to use, as well as which element information to include, then initiate the generation • CSV Import/Export - opens the 'CSV Import/Export' dialog from which you can import and export element data from Enterprise Architect, using CSV files for exchange with spreadsheet tools; the 'CSV Import/Export' dialog allows you to define file specifications that control which element properties are exported and imported, as well as specifying the actual file to use for the export or import • QA Reports and Metrics - open the QA Reports window, which provides a number of pages, each of which provides facilities for reporting on a particular aspect of the elements in the current Package, namely Testing, Maintenance, Dependency Details, Implementation Details and Use Case Metrics; each page provides a particular set of parameters and options to control that type of report generation • Spell Check Current Package - display the 'Spell Check' dialog, which is used to run the spell checker to review the notes of all elements within the current Package
Edit Notes	<p>Click on this button to begin editing the element's Notes. If the Notes are hidden, or displayed in Preview mode, the Notes window will be used for editing, otherwise the Notes field or column within the Specification Manager will be used. With the element selected, the Space bar can be used as a keyboard shortcut to begin editing.</p>
Edit Selection	<p>Click on this button to begin editing the current element's name. With the element selected, the Enter key can be used as a keyboard shortcut to begin editing.</p>
Apply Auto Naming	<p>Display the dialog 'Apply Auto Naming to Elements'. If you have set up auto-naming conventions for the names and/or Aliases of specific types of elements, you can apply those naming conventions to all of the elements of those types in the currently selected Package, in one operation. The dialog groups by type those elements that have defined auto-naming conventions, and shows the effects of</p>

	applying the conventions to the element names and/or Aliases. You can update the names of all the elements in the Package, or select only certain elements to update. The facility for configuring auto-naming conventions can be accessed via this dialog.
Move Up	Click on this button to move the selected element up in the Specification Manager list. The element's position is also reflected in the Browser window.
Move Down	Click on this button to move the selected element down one place in the Specification Manager list. The element's position is also reflected in the Browser window.

Display Panel

The 'Display' panel provides a range of options that make it possible to tailor the appearance of the Specification Manager view, to better display the information you want to examine. There are options providing visual cues, such as highlighting the selected element and using bold fonts to emphasize element names, as well as options to filter the list of elements that is displayed.

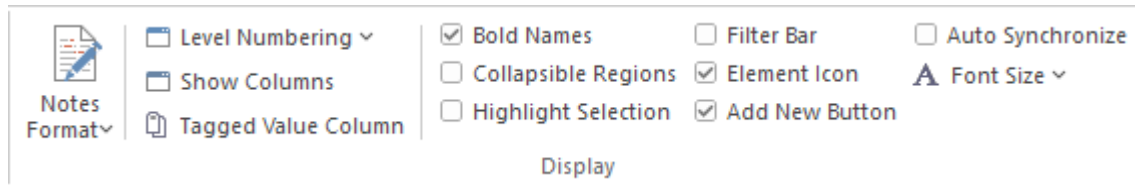

Available Facilities

Facility	Description
Notes Format	<p>Click on the drop-down arrow, to a display a brief menu of commands for customizing the visibility and style of displayed element notes:</p> <ul style="list-style-type: none"> Preview - show the Notes in Preview mode; this limits the Notes displayed to a maximum size and uses the Notes window for editing Full Notes Inlined - show the complete Notes text for each element underneath the element name; in this mode you can create, edit and delete Notes text in the Specification Manager and perform the same operations as are available in the Notes window context menu Full Notes in Column - show the complete Notes text for each element in a new column next to the element names; you have the same freedom to edit the text as for 'Full Notes Inline' Document View - columns are hidden and Notes are displayed inline; use the Enter key as a keyboard shortcut to begin editing. Hide - show no Notes at all; to edit or view the Notes, open the Properties window or docked Notes window
Level Numbering	<p>Clicking the drop-down arrow displays options for applying level numbering and indenting notes for elements contained within the current Package.</p> <ul style="list-style-type: none"> Enable - toggle the display of automatically applied level numbering within the Specification Manager and the Browser window, for elements within the currently displayed Package Indent Description - if you have enabled level numbering, this option is available to indent the element description under each element name, to align with the element name
Show Columns	<p>The Specification Manager can display a wide range of properties for the elements in the selected Specification Package, with each property being shown in a separate column. This command opens the 'Field Chooser' dialog, allowing you to customize the display of the columns so that you show as many or as few as you need, in an appropriate sequence.</p>
Tagged Value Column	<p>Display the 'Add Tag Value Column' dialog. This dialog allows you to add a specific Tagged Value to the list of columns displayed by the Specification Manager. If the current element already has the named Tagged Value, the value can be edited, otherwise the Tagged Value must first be added to that element.</p>

Bold Names	<p>Use this option to turn on or off, the use of Bold element names in the Specification Manager view.</p> <p>When on, all element names, including the names of child elements, are displayed using bold font.</p>
Collapsible Regions	<p>Use this option to enable the use of Expansion boxes on parent elements.</p> <p>If an element has child elements, you can configure the Specification Manager to either:</p> <ul style="list-style-type: none"> • Hide the child elements but provide an expansion box that you can click on to open and collapse the element hierarchy (select the 'Collapsible Regions' option), or • Automatically display the child elements indented underneath the parent element (deselect the 'Collapsible Regions' option)
Highlight Selection	<p>Use this option to actively highlight the currently selected row. When you click on an element name or property, the Specification Manager defaults to indicating the selection with side bars and/or underlines. You can, if you prefer, also highlight the entire row of data for the element, by selecting the 'Highlight Selected Row' option. This is only relevant when columns are visible.</p>
Filter Bar	<p>Use this option to show or hide the Filter Bar, which allows filtering of the visible items in the Specification Manager view.</p> <p>The Filter Bar displays underneath the column headings and consists of a row of fields, one field per column. As you type a value into one of these filter fields, element rows in the Specification Manager list are hidden unless the value in the corresponding column contains the value in the filter field.</p>
Element Icon	<p>This option defaults to selected, to display an element icon in front of each element name in the Specification Manager. The icon is a pictorial representation of the element type, and matches the element type icon shown against the element in the Browser window. Deselect the checkbox to hide the element icons.</p>
Add New Button	<p>This option defaults to selected, to display the Add New button and its associated drop-down menu at the bottom of the Specification Manager display. Deselect the option to hide the button.</p>
Auto Synchronize	<p>Select this checkbox to automatically synchronize the Specification Manager display to the Package selected in the Browser Window. As you click on different Packages in the Browser window, the Specification Manager changes to display the content of the currently-selected Package.</p> <p>If you do not select the checkbox and you move around the model structure the Package displayed remains as the one originally selected by clicking on the 'Design > Package > Specification View' option.</p>
Font Size	<p>Across the Specification Manager view, the various display components such as parent element names, child element names, Notes/property values and column headings each have their own font size. You can select to increase or decrease the font sizes as a set across the display, relative to the current sizes.</p> <p>Specify the default font size based on preference:</p> <ul style="list-style-type: none"> • Small • Medium • Large

Document - Edit Ribbon

The 'Document - Edit' ribbon provides a set of tools and facilities for working with documents such as imported document files and Linked Documents. It becomes available when you open an editable document within Enterprise Architect.

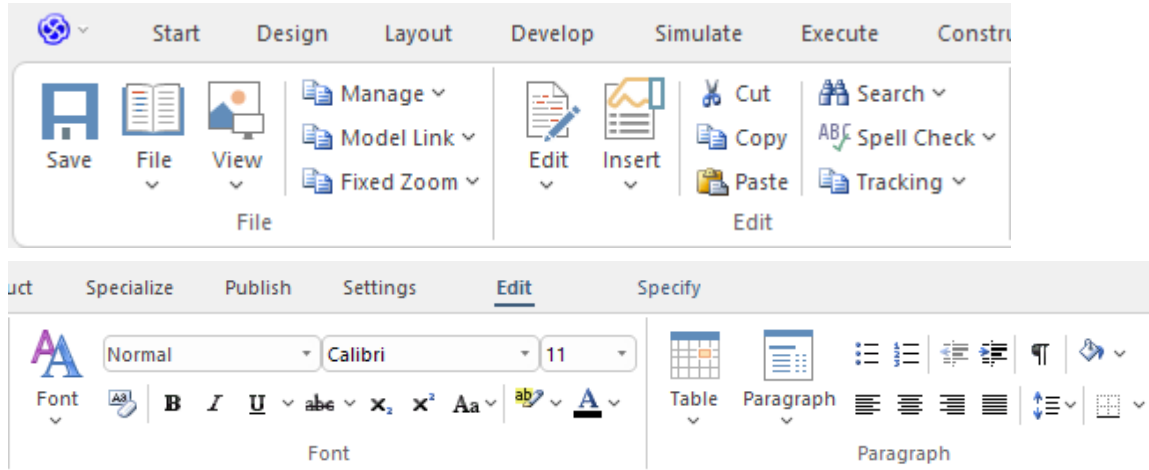

Panels

Panel	Description
File	The 'File' panel helps you to manage internal document files, the way the content displays, file security and objects you can add to the content (such as hyperlinks).
Edit	The 'Edit' panel provides a wide range of facilities for manipulating and checking the text within a document, and searching the content for specific text strings. It also provides facilities for tracking and managing document changes.
Font	The 'Font' panel helps you to completely control the Fonts in a document, including setting Bold, Italics and font types and size. The color of text and background can be altered to create visually attractive documents.
Paragraph	The 'Paragraph' panel helps you to format all aspects of paragraphs in a document including left, right and center alignment and justification. Text indentation, bullets and numbered lists can be added to create well formatted documents. Line spacing, document styles and table borders can be set to facilitate reading.

File Panel

The 'File' panel helps you to manage internal document files, the way the content displays, file security and objects you can add to the content (such as hyperlinks).

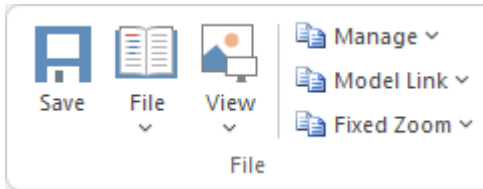

Available Facilities

Facility	Description
Save	Click on this icon to save any changes you have made to the document file. (The icon is not available if no changes are pending).
File	<p>Click on the drop-down arrow and select from a number of options for manipulating the file contents as a whole.</p> <ul style="list-style-type: none"> • Import File - import the contents of an existing document into the current file • Save As (Export to File) - save your document to a different document file • New (Clear Document) - clear the current contents of the document for redesign • Reload from Repository - reload the file contents from the previously-saved version • Page Layout - display the 'Page Setup' dialog and set the page margins for the file • Printer Setup - display the 'Print Setup' dialog and confirm or reselect the core parameters such as page size, or click on the Properties button to define more advanced settings • Print - display the 'Print' dialog to define the print job for the document • Print Preview - display the document as it would appear when printed
View	<p>Click on the drop-down arrow to display options for displaying the document content on the screen.</p> <ul style="list-style-type: none"> • Page Mode - display a full-screen view of the content as pages with borders • Page Mode - Borderless - display a full-screen view of the content with no borders • Fitted Mode - fit the document to the display area • Horizontal Ruler - display or hide the ruler at the top of the page, showing tab stops and paragraph indentation marks • Vertical Ruler - display or hide the ruler against the left edge of the page, indicating the depth of the top and bottom margins of the page • Status Ribbon - display or hide the status ribbon at the bottom of the editing panel, showing the current page number, line number and column number • Hidden Text - show text marked as 'Hidden' using the 'Font Hidden Text' option • Field Names - toggle between displaying field names in the text and displaying

	<p>the field values</p> <ul style="list-style-type: none"> • Hyperlink Cursor - toggle the cursor icon when you 'mouse over' a hyperlink, between the default image (a line or arrow) and a pointing hand • Page Header/Footer - display or hide the text of page headers and footers
Manage	<p>Click on this icon to select from a set of options for protecting the document from being edited or deleted, so that it is safe from accidental change. The Document Editor defaults to locking against protection, so you first turn off the lock and then protect either the whole document or a selected block of text.</p> <ul style="list-style-type: none"> • Protect Document - toggle between setting a lock to prevent any editing or deletion of the entire document, and removing protection so that changes can be made • Text Selection Lock - remove the lock against setting protection on the text of the document • Snap to Grid - (defaults to on) applies a grid to the tab markers and paragraph indents, so that they snap to the nearest sixteenth of an inch • Watermark Picture - display an image file browser and select an image to use as a watermark in the document • Remove Unused Lists - clear unused list formats from the file when you save it, to reduce file size
Model Link	<p>Click on this icon to select from options to create a link between a text string that you highlight in the document and a new or existing object in the model.</p> <ul style="list-style-type: none"> • Glossary Definition - display the 'Glossary Detail' dialog, to create a Project Glossary entry for the highlighted text string • New Model Element - display a short list of types of object to create (or select the 'Other' option to access a wider range of object types) to generate an object of that type from the highlighted text string, in the current Package; the object is linked to the highlighted text in the document • Link to Existing Element - display the 'Select Classifier' dialog, through which you browse for and select an element to link to a highlighted text string • Hyperlink - create a hyperlink from the highlighted text to an existing object in the model; the 'Hyperlink Details' dialog displays, through which you specify the type of object to link to, and its location
Fixed Zoom	<p>Click on this icon to display a list of page magnification options between 75% and 400%, and an option to set a custom magnification of the page anywhere between 10% and 500%.</p>

Edit Panel

The 'Edit' panel provides a wide range of facilities for manipulating and checking the text within a document, and searching the content for specific text strings.

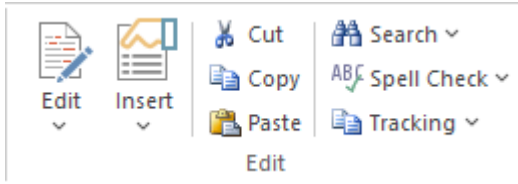

Available Facilities

Facility	Description
Edit	<p>Click on this icon to display and select from a list of editing operations you can perform within your document. This list includes facilities for tracking changes, setting the direction of text flow, and setting up list overrides.</p> <ul style="list-style-type: none"> • Cut - remove a highlighted text string and hold it in the clipboard • Copy - copy a highlighted text string and hold it in the clipboard • Paste - paste a text string from the clipboard into the document at the cursor position • Paste Special - paste a specially-formatted object from the clipboard into the document, such as formatted text or an OLE object • Edit Picture - open the appropriate graphics editor for the selected image, to edit the image • Undo - roll back the last unsaved change made; you can undo a succession of unsaved changes • Redo - re-establish the last unsaved change that has been undone; you can redo a succession of undone changes • Select All - highlight the text of the whole document for performing an operation on it • Repaginate - repaginate the document, and update the 'Page Number' and 'Page Count' fields and the Table of Contents • Edit Section - display the 'Section Parameters' dialog, on which you set up the document properties to apply to the text between two section breaks • Edit Style - display the 'Edit Stylesheet' dialog, through which you create and edit styles to apply to either paragraphs of text or characters • Edit Input Field - display the 'Input Field Parameters' dialog, through which you create or edit a field at the cursor position in the document, for the document users to enter data in • Edit Frame/Drawing Object - display a short list of options for editing or re-positioning a frame or drawing object, including setting the direction of text flow within the object • List and Overrides - display a list of options for setting up paragraph numbering list items, overrides and levels • Page Header/Footer - display a hierarchy of menus for creating, editing and deleting the page headers and footers of the document • Edit Footnote/Endnote - select to add or edit either an end-note or the footnotes

	<p>of the current page</p> <ul style="list-style-type: none"> • Edit OLE Object - open the appropriate editor to edit the embedded OLE object • Inline IME - set the document to accept both single-byte characters and double-byte characters, without having to switch to an external Input Method Editor (IME) application (double-byte characters are complex characters used in languages such as Japanese and Cyrillic) • Document Text Flow - display the 'Document Text Flow' dialog, on which you set the text flow for the whole document to left-to-right, right-to-left, or the default for the system
Insert	<p>Click on this icon to display and select from a list of text breaks, objects, special text structures and special characters to insert in the document at the cursor position.</p> <ul style="list-style-type: none"> • Insert Break - display a short menu from which you select to insert a page break, section break or column break • Embed Picture - insert an image file as a picture in the document • Link Picture - insert a link to an image file in the document • OLE Object - display the 'Insert Object' dialog, from which you can select the appropriate application to create the OLE object in the document • Insert RTF File - insert the complete contents of another document file • Frame - inserts a small frame at the cursor position, which you can then drag to the appropriate size • Drawing Object - display the 'Select Drawing Object' dialog and select to insert a text box, rectangle or line, which you can then drag to the appropriate size • Page Number - insert a page number field at the cursor position • Page Count - insert a page count field at the cursor position • Date and Time - display the 'Insert Current Date and Time' dialog, which you use to create data and/or time fields in the page layout, in one of a selection of formats • Footnote/Endnote - select to insert a footnote or an endnote linked to a marker in the text; a dialog displays in which you enter the marker character and the note text • Bookmark - display the 'Bookmark' dialog, which you can use to create, locate and delete bookmarks in your document • Table of Contents - display a short dialog in which you define the highest and lowest heading levels to reflect in the Table of Contents (you must define the appropriate Table of Contents level styles before doing this); when you click on the OK button, the Table of Contents generates • Data Field - display the 'Data Field Parameters' dialog, in which you enter the field name and the data value of your own data field to insert in the document • Text Input Field - display the 'Input Field Parameters' dialog, in which you enter the field name and characteristics of a field in which the document users can enter their own information • Checkbox Field - display the 'Checkbox Field Parameters' dialog, in which you define a checkbox that the document users can select or clear • Selection Field - display the 'Selection Field Parameters' dialog in which you define a drop-down list field for which the document users can select one of a set of values to display • Hyperlink - display the 'Insert Hyperlink' dialog, on which you enter the hyperlink text and the identifier for the object being linked to, either within the model or external to it

	<ul style="list-style-type: none"> • Non-breaking Space - insert a non-breaking space at the cursor position, so that if the document text flows to a new page at that point, the words linked by the space are kept together • Non-breaking Dash - insert a non-breaking dash at the cursor position, so that if the document text flows to a new page at that point, the words linked by the dash are kept together • Optional Hyphen - insert a hyphen at the cursor position
Cut	Click on this option to remove a highlighted text string and hold it in the clipboard.
Copy	Click on this option to copy a highlighted text string and hold it in the clipboard.
Paste	Click on this option to paste a text string from the clipboard into the document at the cursor position.
Search	<p>Click on this icon to display a short menu of options for locating a text string in the document.</p> <ul style="list-style-type: none"> • Search - open the 'Search Text' dialog, to specify the text string to locate and the initial search parameters • Search Forward - continue the search forwards towards the end of the document, to the next occurrence of the defined text string • Search Backward - continue the search back towards the start of the document, to the next occurrence of the defined text string • Replace - open the 'Replace Text' dialog to search for a text string and replace it with another, in selected text or throughout the document • Go to Line - display a short dialog in which you specify the number of a line in the document to 'jump' the cursor to
Spell Check	<p>Click on this icon to display a set of simple options for checking the spelling in the document.</p> <ul style="list-style-type: none"> • Spell Check - start a spell check on the document, and respond to all apparent spelling errors • Auto Spell Checking - set the system to automatically check all existing text and new text as it is typed or imported into the document, underlining apparent errors in red • Thesaurus - display the 'Thesaurus' dialog in which you can check for alternative or opposite terms for the selected text string • Spelling Options - display the 'Spelling Options' dialog, on which you identify the text features to include or ignore in the check, the language dictionary to apply, what speed and accuracy of check to accept
Tracking	<p>Click on this icon to display a menu of options for enabling and using Change Tracking in the document. These options include:</p> <ul style="list-style-type: none"> • Enable Tracking - turn Change Tracking on and off • Find Next Change - locate and highlight the next tracked change, moving towards the end of the document • Find Previous Change - locate and highlight the previous tracked change, moving towards the start of the document • Accept Change - update the document with the currently-selected change • Accept All Changes - update the document with all changes • Reject Change - remove the change from the document

- | | |
|--|---|
| | <ul style="list-style-type: none">• Reject All Changes - remove all changes from the document• Hide Changes - hides or reveals deleted text and the highlighting on added text in the document• Apply Comment - helps you create a comment on the selected text, which displays in the outside page margin |
|--|---|

Font Panel

The 'Font' panel helps you to completely control the Fonts in a document, including setting Bold, Italics and font types and size. You can alter the color of the text and highlighting to create visually compelling documents.

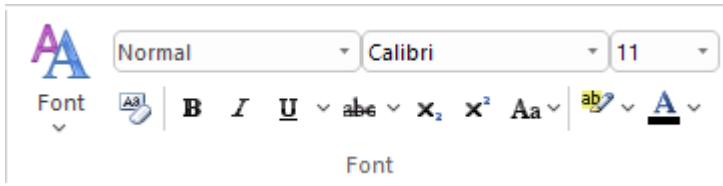

Available Facilities

For many of these facilities, you can either select an icon from the panel or an equivalent option from the 'Font' drop-down menu.

Facility	Description
Font	<p>Click on this icon to display a list of options for changing the appearance of a selected string of characters. These options include:</p> <ul style="list-style-type: none"> • Normal - return changed text to the Normal, unformatted style • Bold - display and print the selected text in bold • Underline - underline the selected text with a single line • Double Underline - underline the selected text with a double line • Italic - italicize the selected text • Subscript - make the selected text a subscript on the immediately preceding text • Superscript - make the selected text a superscript on the immediately preceding text • Strike - run a single line through the selected text • Double Strike - run a double line through the selected text • All Caps - change all selected characters to upper case • Small Caps - change all selected characters to small capitals • Fonts - display the 'Font Selection' dialog, from which you select the typeface and point size to apply to the selected characters • Style - display the 'Select a Style' dialog, from which you select a defined style to apply to the selected characters • Text Highlight - display the 'Color' dialog from which you select and apply a background highlight color for the selected text string • Spacing - display the 'Character Spacing' dialog, on which you select to expand or compress the spacing between characters to a number of Twips that you define, or return the spacing to Normal • Horizontal Scaling - display the 'Horizontal Character Scaling' dialog, on which you set the width of the selected characters to less than or greater than 100% • Hidden - hide the selected text and close up the remaining text; you can reveal the hidden text using the 'View > Hidden Text' option on the 'File' panel • Boxed - place a simple rectangular frame around the selected text • Protect - prevent any changes to the selected text; available if the 'Manage >

	<p>Protection Lock' option is deselected on the 'File' panel</p> <ul style="list-style-type: none"> • Hyperlink - make the selected text into a hyperlink
<style> field	Click on the drop-down arrow and click on the text style to apply to the selected text.
<typeface> field	Click on the drop-down arrow and click on the name of the typeface to apply to the selected text.
<point size> field	Click on the drop-down arrow and click on the point size to apply to the selected text. You can also type a point size into the field.
Clear Formatting	Click on this icon to clear any formatting you have applied to the selected text using the other facilities of the 'Font' panel.
Bold	Toggle the selected text between bold and normal type.
Italic	Toggle the selected text between italics and normal type.
Underline	<p>Click on the icon to underline the selected text with a single line, or to remove the underline. Click on the drop-down arrow and select:</p> <ul style="list-style-type: none"> • Double Underline - underline the selected text with two lines, or to remove the double underline • Underline Color - display a color palette from which you can select a color for the <i>existing</i> underlines, or define a color not presented in the palette
Strikethrough	Click on the icon to put a single strike-through line across the selected text, or to remove the line. Click on the drop-down arrow and select the 'Double Strikethrough' option to do the same with a double line through the text.
Subscript	Click on this icon to toggle the selected text between a subscript (below the level of the adjacent text) and normal.
Superscript	Click on this icon to toggle the selected text between a superscript (above the level of the adjacent text) and normal text.
Character Case	<p>Click on the drop-down arrow and select an option for changing the case of the selected text:</p> <ul style="list-style-type: none"> • lowercase - convert all characters of the selected text to lower case • UPPER CASE - convert all characters of the selected text to upper case
Highlight Text	Click on the drop-down arrow to display the 'Color Palette', and select or define a color to show behind the selected text as a highlight.
Text Color	Click on the drop-down arrow to display the 'Color Palette', and select or define a color in which to display the selected text.

Paragraph Panel

The 'Paragraph' panel helps you to format all aspects of paragraphs in a document to help make the text look attractive and comfortable to read. Formatting options include left, right and center alignment and justification, text indentation, bullets and numbered lists, line spacing, document styles and defining table borders.



Available Facilities

For many of these facilities, you can either select an icon from the panel or an equivalent option from the 'Paragraph' drop-down menu.

Facility	Description
Table	<p>Click on this icon to display a list of facilities for setting up and formatting a table in your document. For options that apply to cells, you can apply the settings to the whole table, just the selected cells, just the column(s) containing the selected cells, or just the rows(s) containing the selected cells.</p> <ul style="list-style-type: none"> • Insert Table - display the 'New Table' dialog and specify how many rows and columns to create; the table defaults to showing the gridlines • Insert Row - add a row above the current row, with the same row properties • Insert Column - add a column to the left of the current column, with the same column properties • Merge Cells - merge the selected cells into one cell, across or down the table, or both • Split Cell Horizontally - split the selected cell into two columns within the row • Split Cell Vertically - split the selected cell into two rows within the column • Delete Cells - display the 'Delete Table Cells' dialog, in which you specify whether to delete just the selected cells, the rows containing the selected cells, or the columns containing the selected cells • Row Position - display the 'Table Row Alignment' dialog, in which you align the row borders with the left margin, the page center or the right margin, either just for the selected row or for the whole table • Row Height - display the 'Row Height' dialog, in which you set the row height to automatically adjust to the row contents, or to only adjust above a minimum height or to always be an exact height (which you specify, in Twips), for just the selected row or for all rows in the table; content that exceeds a fixed row height is not visible in the table • Header Row - set the first row of the table as a header row, which will be duplicated at the top of each section of the table flowing onto a new page • Keep Row Together - set the selected rows to stay together if the table would be split by an automatic page break at those rows • Row Text Flow - display the 'Table Text Flow' dialog, on which you specify whether the text should flow left-to-right or right-to-left, or the direction of the system default; you can apply the setting to selected rows or to the whole table, and the rows are aligned with the left or right margins of the page to match the text flow

	<ul style="list-style-type: none"> • Cell Width - display the 'Set Cell Width' dialog, on which you specify the width of the selected cells and the indent of text within the cells, in Twips • Cell Border Width - display the 'Set Cell Border' dialog on which you set the width of the lines at any or all of the top, bottom, left and right of the selected cells, with the border around either the selected cells as a block or around each individual cell • Cell Border Color - display the 'Set Cell Border Color' dialog, on which you select one color for all the lines of the cell borders or a color for each or any of the border lines, clicking on the border-name button to select the color to apply • Cell Shading - display the 'Cell Shading' dialog, on which you select a shading of the background of the selected cells, from 0% (no shading) darkening to 100% (black) • Cell Color - display the 'Cell Color Selection' dialog, on which you click on the Set Color button and on a background color for the selected cells • Cell Vertical Align - display the 'Cell Vertical Alignment' dialog, on which you align the text in the cells to the top, center or bottom of the cell, or the baseline of the lowest top line of text (if you have applied special formatting to a cell within the selection) • Cell Rotate Text - display the 'Cell Text Rotation' dialog, in which you set the text to display horizontally (as normal), rotated by 90 degrees anticlockwise to flow from the bottom of the cell to the top and left to right, or rotated by 90 degrees clockwise to flow from the top of the cell to the bottom and right to left; this is especially useful when the cells are in the outside columns and act as labels for the content of the body of the table • Select Current Column - select the whole column containing the currently-active cell • Show Gridlines - display or hide the pale blue table and cell borders on the screen, so that you can visualize the layout of the table; the grid is not printable - if you intend to print the table, you must define the borders as having at least minimum width
<p>Paragraph</p>	<p>Click on this icon to display a list of facilities for formatting the selected paragraphs of text in your document.</p> <ul style="list-style-type: none"> • Normal - align the text so that new lines begin parallel with the left margin of the page and flow to the right • Center - align the text so that new lines begin at the center of the page and flow equally towards the left and right margins of the page • Right Justify - align the text so that new lines begin parallel with the right margin of the page and flow to the left • Justify Both - align the text so that lines begin and end parallel with the left and right margins respectively • Double Space - separate the lines within the selected paragraph with double line spacing • Indent Left - indent the selected paragraph one tab space in from the left margin; each selection indents the text one more tab space • Indent Right - indent the selected paragraph one tab space in from the right margin; each selection indents the text one more tab space • Hanging Indent - indent the paragraph except for the first line one tab space • Keep Together - if there is a possibility that the selected text will be split by a page break, set the text to be moved to the top of the next page as a single unit • Keep With Next - if there is a possibility that the selected paragraph will be separated from the next by a page break, set the paragraph to move onto the same page as the next paragraph

	<ul style="list-style-type: none"> • Widow/Orphan Control - prevent the first and last lines of the selected paragraph from being separated from the rest of the text by a page break; at least one other line will stay with or move with the separated text • Page Break Before - set the selected paragraph to print at the top of a new page • Border and Shading - display the 'Paragraph Box' dialog, on which you select to add borders above, below, to the sides and - for multiple-column text - between the columns of the selected text, to format the borders as a single or double thin line or thick line, to set the color of the borders, and to add a shaded background to the selected text; as you increase the percentage shading, the text color changes to contrast with the background • Paragraph Spacing - display the 'Paragraph Spacing' dialog, on which you set the line spacing within the paragraph to one of three standard spacings, or to a point-spacing that you define, or to a multiple line spacing that you define; you can also set extra spacing to apply before and/or after the paragraph • Background Color - displays the 'Color' dialog, on which you select a color as the background of the selected text; note that the text color does not automatically change to contrast with the background, and if this option is used with the 'Border and Shading' option it blocks that text change • Bullet - convert the selected lines of text to a bullet list, or to convert a bulleted list to unbulleted paragraphs • Numbering - convert the selected lines of text to a numbered list, or to convert a numbered list to un-numbered paragraphs • Increase Level - increase the indent of the selected text and move it further in from the left margin • Decrease Level - if the selected text is indented from the left margin, reduce the indent and draw the text closer to the margin • List Numbering - display the 'Apply paragraph numbering using Lists' dialog, which you use to apply a hierarchical numbering system to the paragraphs in the document • Set Tab - display the 'Set a Tab Position' dialog, on which you set the interval for tab points, the type of tab point, and what kind of lead-in line the tab has, if any • Clear Tab - display the 'Clear a Tab Position' dialog and select a single tab from the list to clear • Clear All Tabs - clear all tab settings from the document • Style - display the 'Select a Style' dialog, on which you select a pre-set style to apply to the selected text • Text Flow - display the 'Paragraph Text Flow' dialog, on which you select the direction in which text flows from the opening words - Left-To-Right, Right-To-Left, or the system default direction
<p>Bullets</p>	<p>Click on this icon to convert the selected lines of text to a bullet list, or to convert a bulleted list to unbulleted paragraphs.</p>
<p>Numbers</p>	<p>Click on this icon to convert the selected lines of text to a numbered list, or to convert a numbered list to un-numbered paragraphs.</p>
<p>Decrease Indent</p>	<p>If the selected text is indented from the left margin, click on this icon to reduce the indent and draw the text closer to the margin.</p>
<p>Increase Indent</p>	<p>Click on this icon to increase the indent of the selected text and move it further in from the left margin.</p>

Show Paragraph Markers	Click on this icon to toggle the display of paragraph markers (¶) throughout the document.
Fill	Click on this icon to display a selection of colors, and select one to use as the background color for the selected block of text. If you want to clear the background color, select the 'Default Color' option. If you want to use a color that is not offered in the selection, click on the 'More Colors' option and select or define the color you require.
Left Alignment	Click on this icon to align the left ends of the selected lines of text with the left margin of the page.
Center Alignment	Click on this icon to align the centers of the selected lines of text with the vertical center of the page.
Right Alignment	Click on this icon to align the right ends of the selected lines of text with the right margin of the page.
Left and Right Alignment	Click on this icon to align the ends of the selected lines of text with the left and right margins of the page.
Line Spacing	<p>Click on this icon to display a list of conventional line spacings, and options to customize line spacing and paragraph spacing.</p> <ul style="list-style-type: none"> • 1.0) • 1.5) set the line spacing in the highlighted text to the selected value • 2.0) • 3.0) • Line Spacing Options - display the 'Paragraph Spacing' dialog, on which you set the line spacing within the paragraph to one of three standard spacings, or to a point-spacing that you define, or to a multiple line spacing that you define; you can also set extra spacing to apply before and/or after the paragraph
Borders and Shading	<p>Click on this icon to display a list of options for adding borders to the table cells you have selected - individual cells, groups of cells, rows, columns or the whole table. Other table-formatting options are available from the 'Table' option.</p> <ul style="list-style-type: none"> • Bottom Border - convert the gridline to a black border along the bottom of the selected cell(s) • Top Border - convert the gridline to a black border along the top of the selected cell(s) • Left Border - convert the gridline to a black border along the left edge of the selected cell(s) • Right Border - convert the gridline to a black border along the right edge of the selected cell(s) • No Border - remove any borders around and between the selected cells • All Borders - convert the gridline to a black border around the selected cell(s) and - for multiple cells - between the selected cells • Outside Borders - convert the gridline to a black border around but not between the selected cells • Inside Borders - convert the gridline to a black border between but not around the selected cells • Insert Table - display the 'New Table' dialog and specify how many rows and columns to create in a new table starting at the cursor position; the table

	<p>defaults to showing the gridlines</p> <ul style="list-style-type: none">• View Gridlines - toggle between showing and hiding the pale blue table outlines on the screen display; the gridlines are not printable, so if you want to show borders on the table in the printed document, add cell borders• Borders and Shading - display the 'Cell Shading' dialog, through which you identify which grouping of table cells to shade and the depth of shading to apply
--	---

Customizing Ribbon Sets

The Enterprise Architect ribbons provide access to the functions and facilities of the system, grouped according to work area. If you only work with the facilities of a certain area, such as Coding or Simulation, you can create a Ribbon Set to present just those facilities and hide other facilities that you do not use. You might hide certain panels of a ribbon, or the whole ribbon.

When you open Enterprise Architect, the Start ribbon is expanded in the ribbon bar by default. You can also set a different ribbon to be the default expanded on opening the system.

If you have user security enabled on a model or project, as an administrator you can also define sets of ribbons to be shown or hidden for other users in each of the security user groups. See the *Perspectives for Security Groups* Help topic.

Access

Ribbon	Start > All Windows > Workspace > Workspace Tools > My Ribbon Sets
--------	--

Create a Ribbon Set

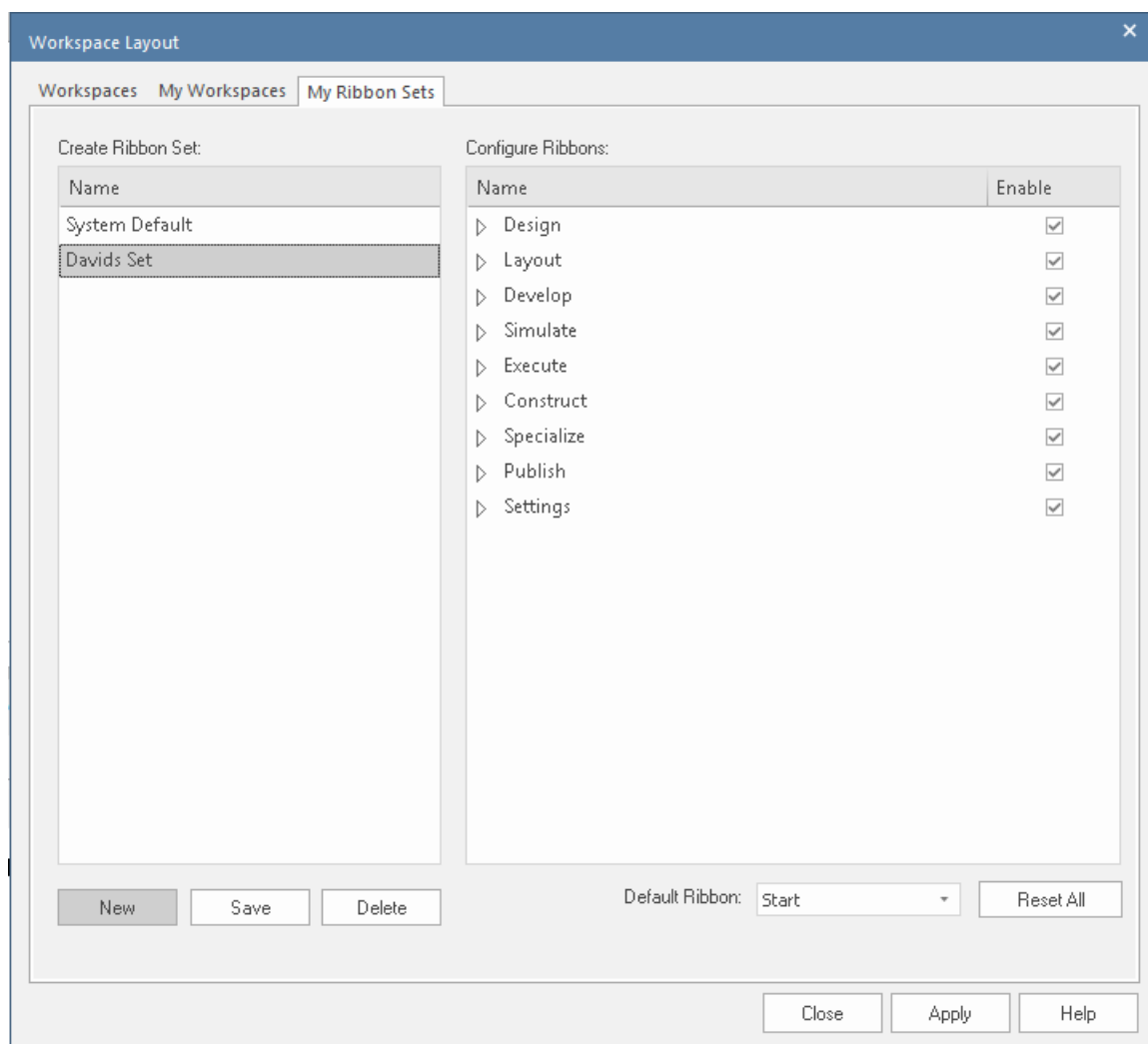

Step	Action
1	On the 'My Ribbon Sets' tab of the Workspace Layout window, the 'Create Ribbon Set' and 'Configure Ribbons' panels display.
2	Click on the New button, and in the 'Create New Ribbon Set' dialog type a name for the Ribbon Set. Click on the OK button to add the new name to the 'Create Ribbon Set' panel and to make it the focus of the 'Configure Ribbons' panel.
3	<p>To hide a complete ribbon, clear the 'Enable' checkbox against the ribbon name.</p> <p>To hide selected panels within a ribbon, click on the white arrowhead to the left of the ribbon name, to display a list of panels that the ribbon contains. For each panel to hide, clear the 'Enable' checkbox against the panel name.</p> <p>Clearing all the panel checkboxes for a ribbon also hides the complete ribbon (you cannot display an empty ribbon).</p>
4	<p>If you want to redisplay a panel or ribbon, select the corresponding 'Enable' checkbox. Selecting a panel within a hidden ribbon shows the ribbon again. Selecting to show a hidden ribbon selects the checkboxes against all its panels; you can then clear individual panels as required.</p> <p>If you have cleared a number of ribbons and/or panels, you can restore the complete set of ribbons and panels by clicking on the Reset All button.</p>
5	<p>If you want to change the default ribbon expanded on opening Enterprise Architect, click on the drop-down arrow in the 'Default Ribbon' field at the foot of the page and select the appropriate ribbon name.</p> <p>If you have hidden a complete ribbon in the 'Configure Ribbons' panel, that ribbon is not available for selection in the 'Default Ribbon' field.</p> <p>The Reset All button also sets the field back to the 'Start' ribbon.</p>
6	Click on the Save button to save your settings, and on the Close button to close the Workspace Layout window.

Notes

- You cannot hide the 'Start' ribbon, 'Specification - Specify' ribbon or 'Document - Edit' ribbon, or any panels that they contain
- If you no longer want to keep a Ribbon Set, click on the name in the 'Create Ribbon Set' panel and click on the Delete button and on the OK button in the confirmation prompt; if there are no Ribbon Sets left, the system reverts to the default of a full set of ribbons with all panels

The Window Selectors

There are many useful windows in Enterprise Architect, through which you can create, review and process data in your model. Each window can be accessed through one of several paths, such as ribbon options, menu options and shortcut keys. However, the fastest way to open either any single window or a succession of windows is through the Window Selectors. You simply press the appropriate Alt key combination and click on the name of the window you require in a grouped list.

Another Alt key combination provides access to lists of workspaces, each of which opens a complete suite of related windows simultaneously.

Each window that you open remains displayed until you specifically close it again.

As you gain experience in working in Enterprise Architect, you will find these Window Selectors invaluable for opening the windows you immediately require, to display or update information on the object currently in focus.

The Window Selectors

Window	Description
Alt+1 - Design Window Selector	The Design Window Selector provides access to the windows for locating, creating and working on objects on the model, including within diagrams. Click on the name of the required window to immediately open it.
Alt+2 - Properties Window Selector	The Properties Window Selector lists the windows for editing the properties, features, structural elements and internal structures of an element. Click on the name of the required window or tab to immediately open it. This window selector can be displayed from both the 'Start > All Windows' panel and the 'Design > Element' panel.
Alt+3 - Collaborate Window Selector	The Collaborate Window Selector provides access to the Collaboration facilities such as Discussions, Reviews, Journal entries, personal conversations and information concerning the overall model.
Alt+4 - Execute Window Selector	The Execute Window Selector provides access to the Simulation, Source Code, Visual Analysis and Process Execution windows and tabs.
Alt+5 - Construct Window Selector	The Construct Window Selector gives access to tools for managing resources, changes, testing and project metrics.
Alt+6 - Publish Window Selector	The Publish Window Selector provides access to facilities for generating static and dynamic reports, exchanging models in part or entire, and keeping the model data accurate and up to date.
Alt+7 - Workspace Window Selector	The Workspace Window Selector is slightly different from the other Window Selectors, in that it lists workspaces for a number of areas of work or tasks. Each workspace opens a suite of related windows together, so that you have all the necessary tools to work on the task. The panel provides workspaces for model design and construction, software analysis and simulation, and whatever you have customized to support your own working requirements

The Design Window Selector

The Design Window Selector provides immediate access to a range of windows for locating, creating and working on objects on the model, including within diagrams. Each window name is a command that, when you click on it, opens that window.

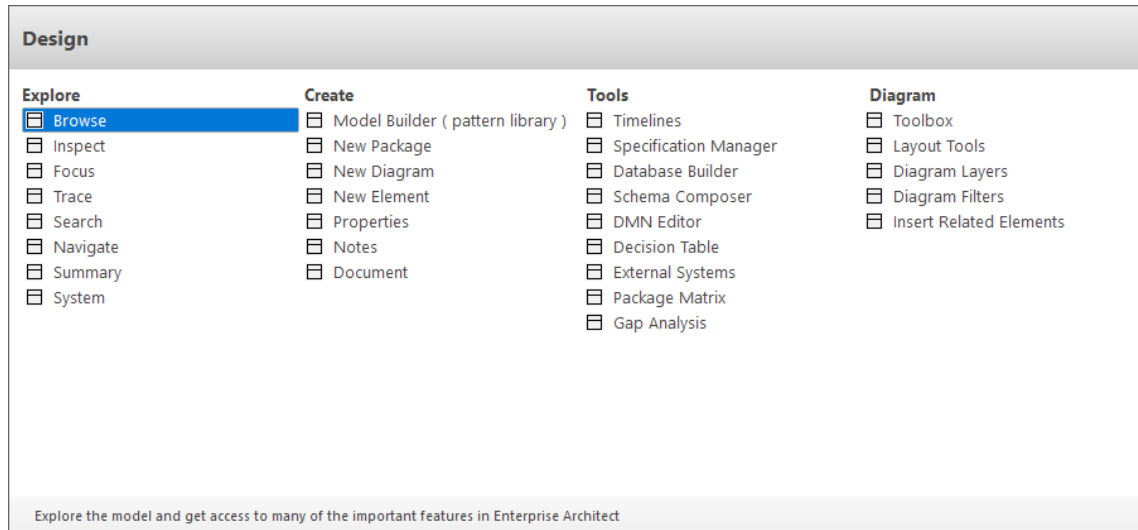

The windows are organized into four sets, as described in the tables of this topic.

Explore

The 'Explore' group of windows help you to locate and display information on the structures of your model.

Option	Description
Browse	Opens or returns focus to the Browser window at the 'Project' tab. The Browser window displays your model objects and features in a number of arrangements, reflecting the content and structure of your model. The Browser window is the primary mechanism for browsing and exploring your model and is the jumping off point for many of the most important features in Enterprise Architect. The 'Project' tab displays the full structure and content of your model
Inspect	Displays the Inspector window at the 'Details' tab. The Inspector window provides the facility of examining the details of an individual element, whether held in the current model or in an external data source. The 'Details' tab lists all the features and characteristics of the element, appropriate to the element type.
Focus	Displays the Focus window, a valuable tool for locating and examining items of importance from anywhere in the overall model. This window provides access to Model Views, Working Sets, and recently opened diagrams and screens.
Trace	Displays the Traceability window, in which you can quickly see what elements are immediately linked to the selected element and in what relationships, and what elements are indirectly linked via a chain of relationships. You can also select a diagram and explore the relationships of all elements in that diagram. The window is mirrored in the 'Trace' tab of the Inspector window.
Search	Opens the Find in Project window, through which you can run a wide range of system and user-defined searches to extract and collate information on aspects of

	your model.
Navigate	Toggles the display of the Navigator toolbar, which identifies the location of the Package or diagram you are currently working in, and provides options to change the focus to another level of the Package's branch, perform relevant operations on the Package, and locate other Packages in the model.
Summary	Displays the Summary window, a brief, read-only summary of the general properties of the currently selected: <ul style="list-style-type: none"> • Element (including Packages) • Attribute • Operation • Test • Maintenance item or • Resource
System	Displays the System Output window, which shows the data that Enterprise Architect generates during each of a range of processes. The data from each type of operation generally has its own tab of this window.

Create

The 'Create' group of windows help you to develop new structures and supporting documents in your model.

Option	Description
Model Builder (pattern library)	Displays the 'Model Builder' window, which offers a range of model structures and patterns from various modeling domains, that can be imported into your project, providing a starting point for your own modeling endeavors.
New Package	Displays the 'New Package' dialog, through which you can create a new Package as a child of the current node.
New Diagram	Displays the 'New Diagram' dialog, through which you can create a new diagram under the current Package, from a range of diagram templates.
New Element	Displays the 'New Element' dialog, through which you can create new elements within specific tool-sets.
Properties	Displays the Properties window, which provides all the properties and characteristics of the selected object such as an element, diagram, connector or operation.
Notes	Displays the Notes window, on which you can add brief notes or longer descriptions and supporting information on the model object.
Document	Displays the Document window, in which you can read, create or edit a more formal or lengthy document on the current element - a Linked Document. You can also run searches to locate other elements that have Linked Documents, and work on those documents as necessary.

Tools

The 'Tools' group of windows help you to create and develop design and analysis structures in your model, such as specifications, databases and schemas.

Option	Description
Timelines Window	Displays the Timelines window, which comprises a number of tabbed pages, that allow the user to display and manage snapshots and baselines of diagrams, packages and elements. This facilitates performing comparisons of the various states of those items, as they change over time throughout the development of the model.
Specification Manager	Displays the Specification Manager window, a simple document-based interface to a selected Package or diagram in the model, providing the means of creating and reviewing elements as text representations of objects in the model.
Database Builder	Displays the Database Builder window, a tailored interface for the data modeler, allowing all database-related modeling tasks to be performed in a single location.
Schema Composer	Displays the Schema Composer window, a versatile tool for quickly and easily defining a variety of formal schema from a model, without needing to use a profile or stereotyped elements when building the definition of an XSD (or other) document.
DMN Editor	Displays the DMN Expression Editor, through which you edit DMN Expressions such as Decision Table, Literal Expression, Boxed Context, Relation, Invocation, etc. and apply the Decision Model and Notation (DMN) standard to model how a decision is made, and generate code for the decisions.
Decision Table	Displays the Decision Table Editor, through which you use the Decision Tables facility as a simple method of modeling how a decision is made.
External Systems	Displays the External Data window, which you can use to integrate the data from external providers such as Jira and Polarion into an Enterprise Architect model.
Package Matrix	Displays the Relationship Matrix, a spreadsheet display of relationships between model elements within a Package, or between elements in two different Packages. You can filter the selection of relationships shown.
Gap Analysis	Displays the Gap Analysis Matrix, which you use to analyze model artifacts to identify potential gaps between solutions. It helps you highlight shortfalls between the original or current solution and the proposed improvement - items that have been deliberately omitted, accidentally left out, or not yet defined.

Diagram

The 'Diagram' group of windows help you to add objects to the diagrams in your model, and format the diagrams.

Option	Description
--------	-------------

Toolbox	<p>Opens the Diagram Toolbox, a panel of icons that you can use to create elements and connectors on a diagram. There are numerous pages available in the Toolbox, each page providing the icons for elements, connectors or patterns for a specific type of diagram under a specific Toolset or Perspective. You can also use the Toolbox icons to add elements to:</p> <ul style="list-style-type: none">• A Package through the Specification Manager and• A Package or an element in the Browser window
Layout Tools	<p>Displays the Layout Tools window, which helps you to set the elements on a diagram in one of a number of regular arrangements such as a circle, a box or a fan.</p>
Diagram Layers	<p>Displays the Filters & Layers window at the 'Layers' tab, which helps you to hide or expose parts of any diagram in segments that represent any concept that is the basis for separating or grouping the elements on that diagram. The layers can be compared to transparencies laid on top of one another in a stack, each transparency showing one grouping of elements on the diagram.</p>
Diagram Filters	<p>Displays the Filters & Layers window at the 'Filters' tab, which helps you to modify the display of diagram components so that the required items are immediately identified, without damaging the structure and integrity of the model.</p>
Insert Related Elements	<p>When a diagram is open this option displays the 'Insert Related Elements' dialog, which helps you to add a group of elements to a diagram based on a defined relationship type and element types.</p>

The Properties Window Selector

The Properties Window Selector provides immediate access to a range of windows for creating, examining and working on the properties of objects in the model, both from the Browser window and in diagrams. Each window name is a command that, when you click on it, opens that window.

You can display this Window Selector from both the 'Start > All Windows' ribbon panel and the 'Design > Element' ribbon panel.

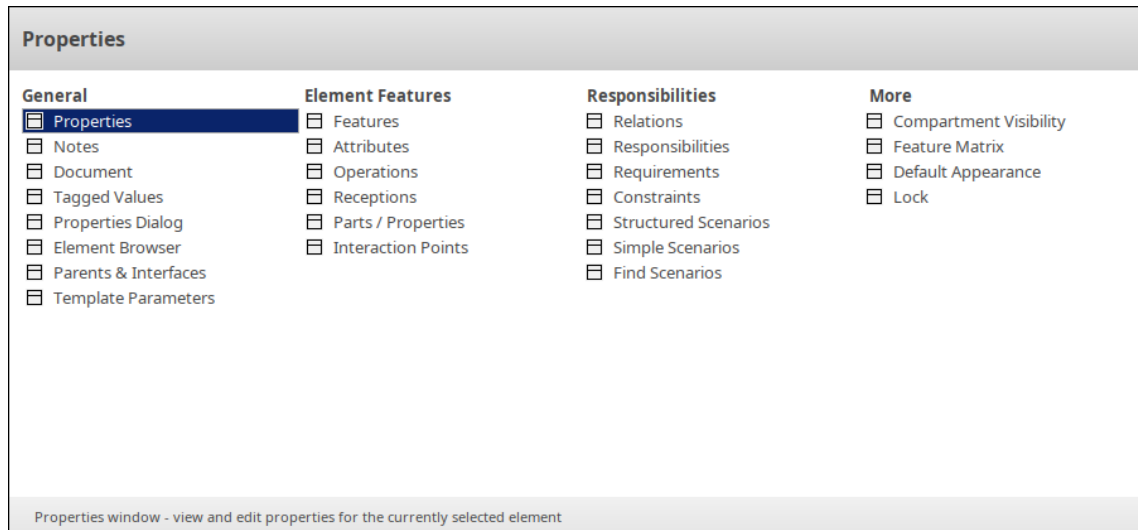

The windows are organized into four sets, as described in the tables of this topic.

General

The options listed in this group provide access to the windows through which you define the nature and purpose of a selected element.

Option	Description
Properties	Displays or returns focus to the Properties window. This window provides a convenient and immediate way to view and edit the properties of a range of modeling objects, including elements.
Notes	Displays or returns focus to the Notes window for the element, in which you can record useful information on the purpose, design and development of the element.
Document	Displays the Document window, in which you can read or edit the contents of a Linked Document on the current element.
Tagged Values	Displays the 'Tags' tab of the Properties window, on which you can: <ul style="list-style-type: none"> Assign a Tagged Value to an Item Modify Tagged Values Assign Notes to a Tagged Value Perform advanced tag management Note that Tagged Values from stereotypes are not displayed on the 'Tags' tab, but in a segment of the 'Element' tab of the window.
Properties Dialog	Displays the 'Properties' dialog for the currently selected element, which helps you

	to define and review a wide range of properties of that element. The tabs and properties shown on the dialog depend on the type of element selected.
Element Browser	Displays the 'Details' tab of the Inspector window, showing all the added-on features and characteristics of the selected element.
Parents & Interfaces	Displays the 'Set Parents and Interfaces' dialog, on which you define the parent element(s) for a generalizable element, or an interface it realizes (implements).
Template Parameters	Displays the 'Templates' dialog, on which you can define: <ul style="list-style-type: none"> • Parameterized Class template parameters and • Binding expressions on a Binding Class

Element Features

The options listed in this group display specific tabs of the Features window, to enable you to manage those features of a selected element.

Option	Description
Features	Displays the Features window, a versatile and seamless tool for creating and editing the features of the selected element. The window has a number of tabs that help you to view, create, delete and manage: <ul style="list-style-type: none"> • Attributes • Operations and, for State elements, operation behaviors • Reception elements • On a State element, Internal Triggers • Structural elements, such as the Parts and Properties added to elements • Edge-mounted elements (Interaction Points) such as ActionPins and Ports that form the primary interaction points of complex, composite elements • Entry Points and Exit Points (Connection Points) on a State element
Attributes	Displays the Features window at the 'Attributes' tab, which enables you to create and manage attributes of a selected element. Attributes define the properties or internal data elements of an element.
Operations	Displays the Features window at the 'Operations' tab, which enables you to create Operations and manage their basic properties. Operations are features of an element that represent the behavior or services an element supports.
Receptions	Displays the Features window at the 'Receptions' tab, which enables you to manage any Receptions on the element. A Reception is a feature of a Classifier, and is derived from a Signal element.
Parts/Properties	Displays the Features window at the 'Parts/Properties' tab, which helps you to define certain constructs and events as structural elements, specifically Part and Property elements in this case.
Interaction Points	Displays the Features window at the 'Interaction Points' tab, which helps you to define certain constructs and events with structural elements, specifically

	Interaction Points or Ports, in this case.
--	--

Responsibilities

The options listed in this group help you to identify, create and delete the entities that define the operating or processing rules applied to an element.

Option	Description
Relations	Displays the Relationships window for the current element, listing the connectors issuing from and linking to the selected element.
Responsibilities	Displays the Responsibility window, which provides a convenient method of quickly identifying, creating and deleting rules applied to an element. The window shows the name and main properties of the entities that impose such rules or restrictions on the element, namely Requirements, Constraints, Scenarios and files.
Requirements	Displays the 'Requirements' tab of the Responsibility window, helping you to sketch out an element's internal requirements (you can switch from this tab to the 'Properties' dialog to add detail to the requirement).
Constraints	Displays the 'Constraints' tab of the Responsibility window, which helps you to sketch out the element's constraints (you can switch from this tab to the 'Properties' dialog to add detail to the constraint). Typical constraints are pre- and post-conditions, which indicate things that must be true before the element is created or accessed and things that must be true after the element is destroyed or its action is complete.
Structured Scenarios	Displays the Scenarios View, offering a wide range of facilities for generating and modifying scenarios, which you can use to quickly and easily define the structure, actions and interactions of the scenarios defined for an element such as a Use Case. These scenarios can be the main (basic) path, alternate paths or exception paths.
Simple Scenarios	Displays the 'Scenarios' tab of the Responsibility window; this is the simplest of the three screens on which you can create and manage scenarios for an element. You use this tab to create a Basic Path scenario or, if a Basic Path already exists, an Alternate Path scenario. A scenario is a real-world sequence of operations that describes how the functional behavior, business workflows and end-to-end business processes represented by an element work in real-time.
Find Scenarios	Executes a search across the model to locate all elements that have defined scenarios.

More

Option	Description
Compartment Visibility	If you have selected an element on an open diagram, this option displays the

	Compartment Visibility window in which you can set a collection of options to display or hide the features of that element on that diagram.
Feature Matrix	Displays the Feature Matrix, on which you create display and manage relationships between two elements where the source and/or target is an element attribute, operation or reception.
Default Appearance	Displays the 'Default Appearance' dialog, on which you can change the global default appearance settings for an element type to a default appearance for a specific selected element wherever it is used in any diagram. The default appearance is the: <ul style="list-style-type: none">• Fill, border and font colors• Font styles, including font face and size• Border thickness
Lock	If you have selected an element, diagram or Package, this option displays the 'Lock Element' dialog on which you set or release a lock against other users being able to update the object.

The Collaborate Window Selector

The Collaborate Window Selector provides immediate access to a range of windows for collaborating with other members of your modeling team. Each window name is a command that, when you click on it, opens that window.

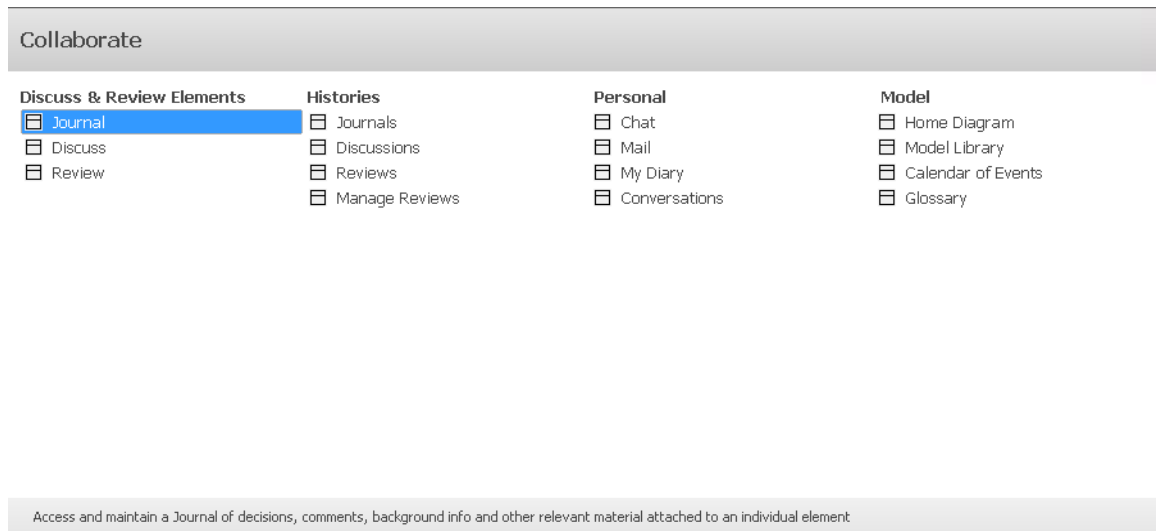

The windows are organized into four sets, as described in the tables of this topic.

Discuss & Review Elements

The 'Discuss & Review Elements' group of windows help you to discuss and review model elements.

Option	Description
Journal	Opens or returns focus to the Discuss & Review window at the 'Journal' tab. The Journal allows you to, for a selected object or diagram, maintain a daily log of ideas, comments, notes, suggestions, to-do lists and other reminders.
Discuss	Opens or returns focus to the Discuss & Review window at the 'Discuss' tab. You can select an individual element or diagram and develop a discussion that is directly associated with that object.
Review	Opens or returns focus to the Discuss & Review window at the 'Review' tab, through which you can set up and conduct a formal review of one or more elements and/or diagrams as defined by a Review element.

Histories

The 'Histories' group of windows help you to look back at the history of discussions and reviews of elements and diagrams in your model over a period of time that you can set.

Option	Description
Journals	Opens or returns focus to the Discuss & Review History window at the 'Journals' tab. The 'Journals' tab lists the elements across the model against which journal comments have been posted.

Discussions	Opens or returns focus to the Discuss & Review History window at the 'Discussions' tab. The 'Discussions' tab shows the Discussions that have been recorded on elements across the model.
Reviews	Opens or returns focus to the Discuss & Review History window at the 'Reviews' tab. The 'Reviews' tab shows the activity in formal reviews across the model, listing the items in which activity has occurred.
Manage Reviews	Opens the Reviews view, which lists all the Review elements in your model. It shows, for a selected Review element, the details of the elements and diagrams under review, allowing you to quickly see what reviews are taking place and what is happening within them.

Personal

The 'Personal' group of windows help you to communicate with other members of your team.

Options	Description
Chat	Opens or returns focus to the Chat & Mail window at the 'Chat' tab. The 'Chat' tab provides a facility for following and participating in quick conversations with individuals or members of a user group on any topic.
Mail	Opens or returns focus to the Chat & Mail window at the 'Model Mail' tab. This provides you with the ability to send, receive and respond to emails within the project team.
My Diary	Opens or returns focus to the Chat & Mail window at the 'My Diary' tab. In your personal diary you can type all kinds of ideas, notes, suggestions, to-do lists and other reminders of what you have done or intend to do in the model.
Conversations	Opens or returns focus to the Discuss and Review - History window at the 'Chat' tab. This lists the recent Chat conversations that you have been a part of or within groups that you are a member of.

Model

The 'Model' group of windows help you to organize your project.

Options	Description
Home Diagram	The Home Diagram command opens your home diagram, if you have one defined.
Model Library	Opens or returns focus to the Library window. The Library window is a place where documents such as specifications, requirements and project guidelines can be stored in the model.
Calendar of Events	Opens the Calendar view. This provides a project management overview, in calendar format, of the deployment of resources, timeframes for tasks, and

	upcoming project events such as milestones and meetings.
Glossary	Opens the Glossary View for the project, showing definitions of terms and, if you are in a project that has been translated into another language, the translations of the terms.

The Execute Window Selector

The Execute Window Selector provides immediate access to a range of windows for running simulations, working with source code, and analyzing and executing code. Each window name is a command that, when you click on it, opens that window.

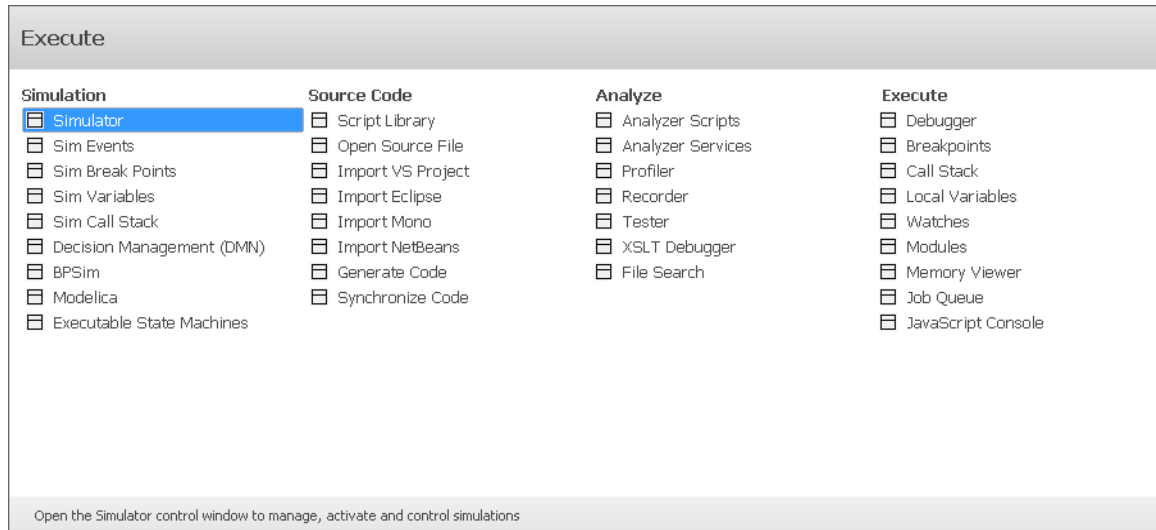

The windows are organized into four sets, as described in the tables of this topic.

Simulation

The 'Simulation' group of windows help you to perform, check and manage model simulations of the processing defined in sections of your model.

Options	Description
Simulator	Displays the Simulation window, which provides the main interface for starting, stopping and stepping through your Simulation.
Sim Events	Displays the Simulation Events window, which is where you manage triggers and sets of events in a simulation.
Sim Break Points	Displays the 'Simulation Breakpoints' tab of the Breakpoints & Events window, which enables you to interrupt and inspect the Simulation process.
Sim Variables	Displays the Simulator Locals window, which shows all current simulation variables when the simulation is single stepping or paused at a breakpoint.
Sim Call Stack	Displays the Call Stack window which, during a Simulation, displays information about the threads and current execution context of the Simulation.
Decision Management (DMN)	Displays the DMN Simulation window. Using Decision Model and Notation (DMN) features you can not only model the decisions that your organization makes but also run simulations from these models to predict outcomes based on example data sets.
BPSim	Displays the Configure BPSim window, through which you define a Business Process Simulation (BPSim) configuration to be represented and contained in a BPSim Artifact element. The configuration is created specifically for and from an

	existing Business Process, defined in BPMN.
Modelica	Displays the Configure SysML Simulation window, the interface through which you can provide run-time parameters for executing the simulation of a SysML model.
Executable State Machines	Opens the Find in Project view and performs an Executable StateMachines search, listing all Executable StateMachines in the model.

Source Code

The 'Source Code' group of windows help you to generate, import and synchronize code from sources both internal to the model and external.

Options	Description
Script Library	Displays the Scripting window, which lists all available scripts in the model according to group.
Open Source File	Launches a 'File Open' dialog, through which you open a source file in a text editor within Enterprise Architect.
Import VS Project	When you have selected a parent Package in the Browser window, displays the Visual Studio Solution Import window through which you can import software projects authored in Visual Studio.
Import Eclipse	When you have selected a parent Package in the Browser window, displays the Eclipse Project Import window through which you can import software projects authored in Eclipse.
Import Mono	When you have selected a parent Package in the Browser window, displays the Visual Studio Solution Import window through which you can import software projects authored in Mono.
Import NetBeans	When you have selected a parent Package in the Browser window, displays the NetBeans Project Import window through which you can import software projects authored in NetBeans.
Generate Code	Displays the 'Generate Code' dialog, through which you can generate programming code from a UML element structure.
Synchronize Code	Displays the 'Synchronize Package Contents' dialog, through which you can synchronize the model and source code, creating a model that represents the latest changes in the source code and vice versa.

Analyze

The 'Analyze' group of windows help you to analyze the performance of the applications you are developing, in whole or in part, in a number of ways.

Options	Description
Analyzer Scripts	Displays the Execution Analyzer window, which enables you to manage all Analyzer scripts in the model.
Analyzer Services	Displays the Analyzer Services window, which lists the status of each Enterprise Architect service named in the config file, and its state.
Profiler	Displays the Profiler window, which allows you investigate application tasks that are determined to be performing slower than expected; you can see the actions that are consuming the application and the functions involved.
Recorder	Displays the Record & Analyze window, which helps you to record the live execution of an application and to generate a Sequence diagram from those recordings.
Tester	Displays the Testpoints window, through which you can develop a scheme by which constraints and rules governing the behavior of objects can be taken from the model and applied to one or more applications.
XSLT Debugger	Displays the XSLT Debugger window and the System Output window at the 'XSLT Transformation' tab, to run a transformation, control the process and inspect the state of the transformation using Enterprise Architect's debugger in combination with breakpoints.
File Search	Displays the Find in Files window, through which you can execute File Text Searches.

Execute

The 'Execute' group of windows help you to view the execution of code and manage various parameters such as the breakpoints, variables, DDLs and memory used in the execution.

Options	Description
Debugger	Displays the Debug window from which a debugging session can be controlled and output from the debugging session can be examined.
Breakpoints	Opens the Breakpoints and Markers window, which allows you to enable, disable, delete and otherwise manage breakpoints and markers in your source code.
Call Stack	Opens the Call Stack window, which is used to display all currently running threads in a process.
Local Variables	Opens the Locals window, which displays variables of the executing system.
Watches	Opens the Watches window, which can be used to evaluate data items that are not available as Local Variables. This window is most useful for native code (C, C++, VB).
Modules	Displays the Modules window, which for .NET and native Windows applications lists the DLLs loaded by the debugged process.

Memory Viewer	Displays the Memory Viewer, which can display the raw values of memory in hex and ASCII.
Job Queue	Opens the Job Queue window, which streamlines the process of working with Analyzer Scripts.
JavaScript Console	Opens the Console window, a command line interpreter through which you can quickly enable a script engine and enter commands to act on the script.

The Construct Window Selector

The Construct Window Selector provides immediate access to a range of features including resource management, testing, change management and project management. Each window name is a command that, when you click on it, opens the window covering that feature.

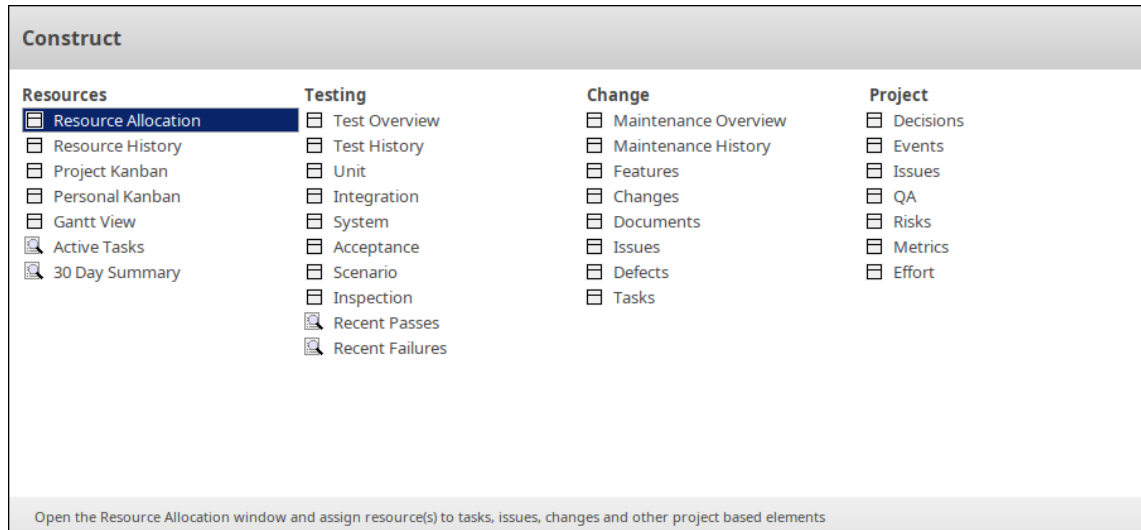

The features are organized into four sets, as described in the tables of this topic.

Resources

The 'Resources' group of windows provides access to features for general project management including managing task and resource allocation.

Option	Description
Resource Allocation	Opens the Resource Allocation window which displays a Gantt chart where you can assign resources working on tasks. The Gantt chart displays all resources/tasks assigned to the currently selected Element.
Resource History	Displays the Construct History window which provides a summary of all project management transactions over a given period, with separate tabs for Tests, Resource Allocations and Maintenance objects.
Project Kanban	Opens the repository's default Kanban diagram which can be used for visually defining and tracking a range of work items and their current stage of development.
Personal Kanban	In a shared security-enabled model environment, this opens a personalized Kanban diagram which can be used to visually track of a range of elements of particular relevance to that user.
Gantt View	Opens the Project Gantt View which illustrates a project schedule by showing a visual timeline of the start and finish dates of assigned resources.
Active Tasks	Opens the Active Tasks search in the Find in Project facility. This will return the set of tasks that are currently set as active (percentage complete < 100).
30 Day Summary	Opens the 30 Day Task Summary search in the Find in Project facility. This provides a brief summary of the work allocated to each resource over the last 30

	days.
--	-------

Testing

The 'Testing' group of windows provides access to features used in testing and test management.

Option	Description
Test Overview	Displays the Tests Cases window where you can create and manage test scripts for model elements. This supports unit, integration, scenario, system, acceptance and inspection tests.
Test History	Opens the 'Test' tab on the Construct History window, which provides a project management summary, over a given period, of the Tests being run across the model.
Unit	Opens the 'Unit' tab in the Tests Cases window where you can create and manage unit tests for the currently selected element.
Integration	Opens the 'Integration' tab in the Tests Cases window, where you can create and manage integration tests for the currently selected element.
System	Opens the 'System' tab in the Tests Cases window where you can create and manage system tests defined for the currently selected element.
Acceptance	Opens the 'Acceptance' tab in the Tests Cases window where you can create and manage acceptance tests for the currently selected element.
Scenario	Opens the 'Scenario' tab in the Tests Cases window where you can create and manage scenario tests for the currently selected element.
Inspection	Opens the 'Inspection' tab in the Tests Cases window where you can create and manage inspection tests for the currently selected element.
Recent Passes	Opens the <i>Passed Tests</i> search in the Find in Project facility. Searches the project for elements having test records where the 'Status' value is 'Pass'. In the <Search Term> you can specify the number of days in the period to search for.
Recent Failures	Opens the <i>Failed Tests</i> search in the Find in Project facility. Searches the project for elements having test records where the 'Status' value is 'Fail'. In the <Search Term> you can specify the number of days in the period to search for.

Change

The 'Change' group of windows provides a quick reference to the change management features including defects, maintenance, issues, changes and features.

Option	Description

Maintenance Overview	Opens the 'Maintenance Overview' tab on the Maintenance window, which provides a summary of the features, changes, issues and other maintenance details for the currently selected element.
Maintenance History	Opens the 'Maintenance' tab on the Construct History window, which provides a summary of the features, changes, issues and other maintenance details for a selected timeframe. This is regularly updated on model changes.
Features	Opens the 'Features' tab on the Maintenance window, which provides a list of the features and options to add new features to the currently selected element.
Changes	Opens the 'Changes' tab on the Maintenance window. This provides a list of the changes and options to add new changes to the currently selected element.
Documents	Opens the 'Documents' tab on the Maintenance window, which provides a list of the Documents logged for the currently selected element.
Issues	Opens the 'Issues' tab on the Maintenance window. This provides a list of the issues logged for the currently selected element and options to add new issues.
Defects	Opens the 'Defects' tab on the Maintenance window. This provides a list of the defects logged for the currently selected element, as well as options to add new defects.
Tasks	Opens the 'Tasks' tab on the Maintenance window. This provides a list of the tasks logged for the currently selected element, as well as options to add new tasks.

Project

The 'Project Tools' window provides access to features for recording against an element details such as decisions, events, effort, risks, and metrics. The Issues and QA are at the project level.

Option	Description
Decisions	A record of decisions or choices made on an element.
Events	A record of events or actions taken on an element.
Issues	The Project Issues are a record of issues on the repository or project level as distinct from the element Issues in the Change area. These are for recording events, occurrences and situations that impact on project development and delivery.
QA	The Quality Assurance reporting or System Documents provide pre-defined reporting, across the repository, on testing, dependencies, maintenance and resources.
Risks	A record of any risks associated with the element.
Metrics	A record of metrics measured for the element.
Effort	A list of effort expended in work on the element.

The Publish Window Selector

The Publish Window Selector provides access to commands that facilitate publishing and exchanging model data.

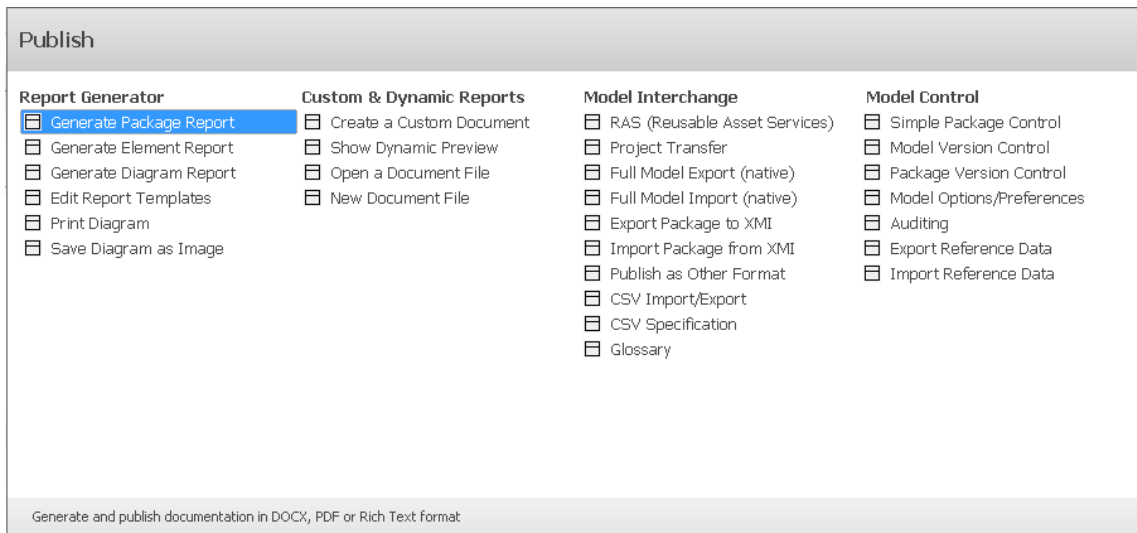

The Publish commands are organized into four sets, as described in the tables of this topic.

Report Generator

The 'Report Generator' commands focus on the specification and generation of reports of model data, including the printing or saving of model diagrams as images.

Option	Description
Generate Package Report	Use this command to generate a report on the currently selected Package. The 'Generate Documentation' window will be displayed, using the current Package name as the default output filename. This window is used to select the report template, style-sheet and cover page. It also allows you to specify a range of filters and other options that will affect the generated report.
Generate Element Report	Use this command to generate a report on the currently selected element or elements. The 'Generate Documentation' window will be displayed. This window is used to select the report template, style-sheet and cover page. It also allows you to specify a range of filters and other options that will affect the generated report.
Generate Diagram Report	Use this command to generate a report of the diagrams within the currently selected Package hierarchy. The 'Generate Documentation' window will be displayed, with the system template 'Diagram Report' selected as the default. The 'Diagram Report' template generates only images of the model diagrams. You can use the 'Generate Documentation' window to select a different report template, style-sheet or cover page. It also allows you to specify a range of filters and other options that will affect the generated report. The current Package name is used as the default output filename.
Edit Report Templates	This command opens the Document Template Design window. The Document Template Designer is used to create and edit report templates that

	<p>define:</p> <ul style="list-style-type: none"> • The model components to report on • The information to extract on each component and • The styles and layout of the report <p>It can also be used to design Stylesheets, Cover Pages and Tables of Contents.</p>
Print Diagram	<p>Displays the 'Print' window, for the currently open diagram.</p> <p>Use the window to select the printer device, set printer properties and specify the number of copies to print.</p> <p>Click on 'OK' to print the diagram.</p>
Save Diagram as Image	<p>Creates an image of the currently open diagram and saves that image to a file of your choosing.</p>

Custom and Dynamic Reports

The 'Custom and Dynamic Reports' group of commands allows you to create and view documents in Enterprise Architect's Document Editor window.

Option	Description
Create a Custom Document	<p>Displays the 'Create Custom Document' window, to create a 'Custom Document' artifact in the currently selected Package.</p> <p>Custom Documents provide a way to include dynamic content that is dragged into the document from the Browser window, including Packages, diagrams, elements and features. Every time you open the document the content is dynamically refreshed from the model objects you have included and from the template instructions.</p>
Show Dynamic Preview	<p>Opens the 'Dynamic Document View' window.</p> <p>The 'Dynamic Document' view in the main work area helps you to instantly generate a document on a selected element, using one of a range of templates to immediately display the information you require in the most appropriate structure and format. The document can be printed, but is not stored electronically - it is dynamically generated for the current element whenever you select the view and when you change the template. You cannot edit the document contents in the view.</p>
Open a Document File	<p>Opens a document, selected from the file system, in Enterprise Architect's code or document editor window.</p>
New Document File	<p>Opens a new, empty document that can be saved to your file system. (This document is not saved within your Enterprise Architect model.)</p> <p>The Document Editor window and 'Document Edit' ribbon are displayed, and the new document is opened for editing in the editor window.</p> <p>When saving the document, a 'File Chooser' dialog is displayed, allowing you to specify a filename and folder for creating the new file on your file system.</p>

Model Interchange

The 'Model Interchange' list of commands provides facilities for exporting and importing model data to and from XML files, to support sharing models with other Enterprise Architect projects and with other modeling tools.

Option	Description
RAS (Reusable Asset Service)	The Reusable Asset Service (RAS) provides a convenient mechanism for modelers to distribute or download reusable model structures, as well as project baselines. The shared repository is accessible via a Pro Cloud Server connection, making it accessible by distributed teams.
Project Transfer	The Project Data Transfer feature supports transferring the full set of data from one repository into another repository, as an overwrite process. It supports these types of transfer: <ul style="list-style-type: none"> • A file repository to a DBMS repository • A DBMS repository to an existing project file • A DBMS repository to another DBMS repository • A file repository to a file repository
Full Model Export (native)	The Full Model Export (native) option provides a Project Transfer by exporting the current project to Native XML. The export process will generate multiple Native XML files, representing the data of the project. This can then be imported to another repository using the Full Model Import (Native) option.
Full Model Import (native)	The Full Model Import (native) option imports a set of Native XML files generated by the Full Model Export (native) option.
Export Package to XMI	This option is used to export a Package-tree from your model to a file in one of several XMI (XML-based) or Native formats. The exported file contains all the information required for performing Enterprise Architect-to-Enterprise Architect transfers, as well as for options exporting to other modeling tools.
Import Package from XMI	This command is for importing a Package, or Package hierarchy, from an XML file containing model information in XMI format. The file will have been created by export from Enterprise Architect or from some other compatible modeling tool. The new Package will be imported as a child of the currently selected Package.
Publish as Other Format	Displays the Publish Model Package window, which allows you to export the selected Package to a file in one of several XML formats. The available formats allow users to import the file into other modeling tools.
CSV Import/Export	This command displays the CSV Import/Export window. Within Enterprise Architect, you can import and export information on elements to and from comma-separated value (CSV) text files. The CSV Import/Export window is used to select the CSV specification that defines <i>what</i> will be exported (which element properties) and the file that it will be exported to, or imported from.
CSV Specification	This command displays the CSV Import/Export Specification window, with which you can define a CSV import/export specification. The specification defines the: <ul style="list-style-type: none"> • Fields from the spreadsheet in the order they are imported or exported • Source or target filename (optional) and

	<ul style="list-style-type: none"> • Delimiter between columns
Glossary	<p>Opens the Project Glossary View.</p> <p>The Model, or Project, Glossary consists of a list of defined terms for your project. The Project Glossary View provides options to review the terms of different types already defined for a model.</p>

Model Control

The 'Model Control' commands are related to the change management of your model data and include Version Control configuration as well as Auditing.

Option	Description
Simple Package Control	<p>Displays the 'Package Control Options' dialog.</p> <p>In order to configure a Package to save and load in Native/XMI format to a named file, you use the 'Package Control Options' dialog to flag the Package as being controlled and to set a number of options. These options include setting the filename to save to/load from, the type of Native/XMI to import and export, and whether to export and/or import the Native/XMI in a batch process.</p>
Model Version Control	<p>Displays the 'Version Control Settings' dialog.</p> <p>To set up a Version Control configuration on your model, you define a number of settings that control how the status of your model is communicated to your Version Control system. You define these settings using the 'Version Control Settings' dialog.</p>
Package Version Control	<p>Displays the 'Package Control Options' dialog.</p> <p>Once your Version Control application is set up and you have Version Control configurations in place, you can use the 'Package Control Options' dialog to place the individual Packages in your model under Version Control. To put a Package under Version Control, you:</p> <ul style="list-style-type: none"> • Flag the Package as a controlled Package • Specify the Version Control configuration to control it and • Associate an XMI file with the Package
Model Options/Preferences	<p>Opens the 'Manage Model Options' dialog for configuring a number of model or project based options covering Enterprise Architect features. These include:</p> <ul style="list-style-type: none"> • General options • Baseline configuration for RAS storage • Cloud administration • Translation configuration • Collaboration across projects • Review of Status locks • Source Code Engineering settings
Auditing	<p>Opens the Auditing view, which covers the audit configuration and view of the audit history. Auditing records model changes, including when the change occurred and who made it. It records changes to Packages, elements, features, connectors and</p>

	diagrams, detailing the creation, modification and deletion of these items.
Export Reference Data	Opens the 'Export Reference Data' dialog. Reference data includes meta-information for properties and base values, as well as option configurations, document templates, tool features and more. You can conveniently export all or specific parts of your model reference data to an .XML file for exchanging with other repositories.
Import Reference Data	Opens the 'Import Reference Data' dialog for importing meta-information into your model from an .XML file that was exported out of another model or from an iteration of the current model.

The Workspace Window Selector

The Workspace Window selector provides access to commands for applying a wide range of predefined workspace layouts. Each layout name is a command that, when you click on it, opens and arranges various windows, positioned, grouped and sized in a manner that facilitates the workflow of the task at hand.

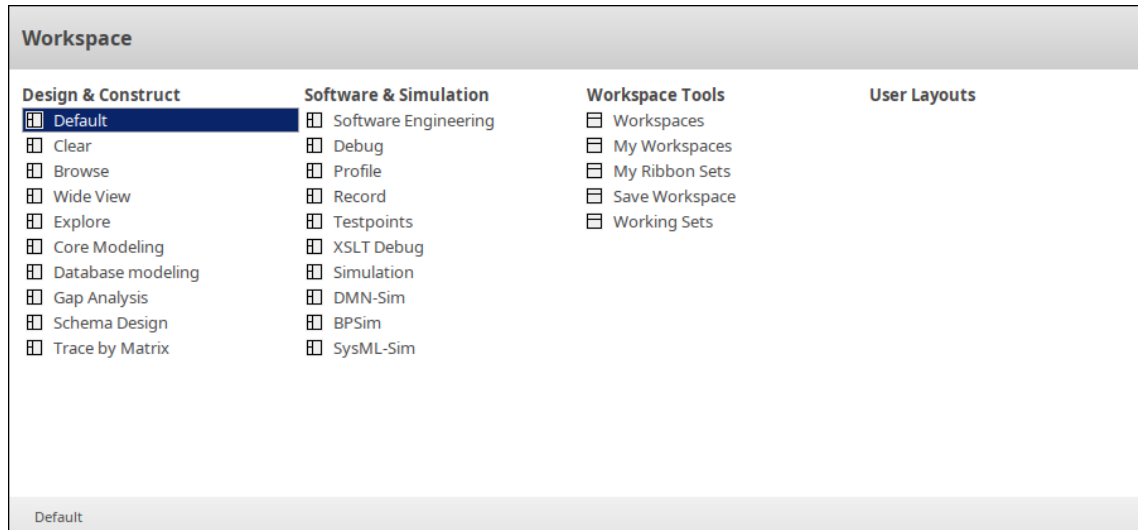

The workspace commands are organized into four sets, as described in the tables of this topic.

Design and Construct

This set of commands provides access to workspace layouts tailored for use in general modeling tasks as well as some specific tasks, such as database modeling or designing XML Schemas.

Options	Description
Default	<p>Applies the 'Default' workspace layout, which is a good starting point for a range of general modeling tasks.</p> <p>These windows are displayed:</p> <ul style="list-style-type: none"> • Main work area (for diagrams) • Browser and Inspector windows grouped together • Properties and Notes windows
Clear	<p>Applies the 'Clear' workspace layout. This clears the desktop by closing all 'docked' windows. You can then open the specific windows that you want.</p> <p>In this layout, only the menu ribbon and the main work area are visible.</p>
Browse	<p>Applies the 'Browse' workspace layout, designed for browsing the model and its element properties.</p> <p>These windows are displayed:</p> <ul style="list-style-type: none"> • Main work area • Browser, Inspector and Focus windows grouped together
Wide View	<p>Applies the 'Wide View' workspace layout.</p> <p>This layout has the main work area occupying the full width of the application desktop. Other open windows are 'auto-hidden'.</p>

	<p>These windows are displayed:</p> <ul style="list-style-type: none"> • Main work area • Browser and Inspector windows grouped together ('auto-hidden' to the left) • Properties and Notes windows ('auto-hidden' to the right)
Explore	<p>Applies the 'Explore' workspace layout, for use in 'exploring' the features of your model.</p> <p>These windows are displayed:</p> <ul style="list-style-type: none"> • Main work area • Browser, Inspector and Focus windows grouped together • Responsibility and Maintenance windows grouped together • Summary window • Discuss & Review and Chat & Mail windows grouped together
Core Modeling	<p>Applies the 'Core Modeling' workspace layout, for use when performing core modeling tasks.</p> <p>These windows are displayed:</p> <ul style="list-style-type: none"> • Main work area • Browser and Inspector windows grouped together • Properties and Notes windows grouped together • Pan & Zoom, Layout Tools and Filters & Layers windows grouped together
Database Modeling	<p>Applies the 'Database Modeling' workspace layout, for use when performing Database Modeling tasks.</p> <p>These windows are displayed:</p> <ul style="list-style-type: none"> • The Database Builder window, occupying the main work area • Browser and Inspector windows grouped together • Properties and Notes windows
Gap Analysis	<p>Applies the 'Gap Analysis' workspace layout, for use when performing Gap Analysis.</p> <p>These windows are displayed:</p> <ul style="list-style-type: none"> • The Gap Analysis Matrix, occupying the main work area • Browser and Inspector windows grouped together (on the left) • Properties window (also on the left)
Schema Design	<p>Applies the 'Schema Design' workspace layout, for use when modeling Schema Designs.</p> <p>These windows are displayed:</p> <ul style="list-style-type: none"> • The Schema Composer, occupying the main work area • Browser and Inspector windows grouped together • Properties and Notes windows
Trace by Matrix	<p>Applies the 'Trace by Matrix' workspace layout, which uses the Relationship Matrix for tracing relationships between model elements.</p> <p>These windows are displayed:</p> <ul style="list-style-type: none"> • The Relationship Matrix, occupying the main work area • Browser and Inspector windows grouped together

	<ul style="list-style-type: none"> • Properties and Notes windows
--	--

Software & Simulation

This set of commands provides access to workspace layouts tailored for use in performing specific tasks in software engineering and model simulation.

Options	Description
Software Engineering	<p>Applies the 'Software Engineering' workspace layout, for use when performing general Software Engineering tasks.</p> <p>These windows are displayed:</p> <ul style="list-style-type: none"> • Main work area • Browser, Inspector and Execution Analyzer windows grouped together as tabs • Features window (contains pages for features such as attributes, operations and receptions) • Properties and Notes windows
Debug	<p>Applies the 'Debug' workspace layout, for use when debugging software.</p> <p>These windows are displayed:</p> <ul style="list-style-type: none"> • Main work area • Browser, Inspector and Execution Analyzer windows grouped together • Breakpoints & Markers, Watches, Modules and Memory Viewer windows grouped together • Debug, Local and Call Stack windows grouped together
Profile	<p>Applies the 'Profile' workspace layout, for use when profiling software.</p> <p>These windows are displayed:</p> <ul style="list-style-type: none"> • Main work area • Browser and Execution Analyzer windows grouped together • Profile window
Record	<p>Applies the 'Record' workspace layout, for use when recording program execution.</p> <p>These windows are displayed:</p> <ul style="list-style-type: none"> • Main work area • Browser and Execution Analyzer windows grouped together • Record & Analyze window
Testpoints	<p>Applies the 'Testpoints' workspace layout.</p> <p>These windows are displayed:</p> <ul style="list-style-type: none"> • Main work area • Browser and Execution Analyzer windows grouped together • Testpoints window
XSLT Debug	<p>Applies the 'XSLT' workspace layout, for use when debugging XSLT.</p> <p>These windows are displayed:</p>

	<ul style="list-style-type: none"> • XSLT Debugger window open in main work area • Browser and Execution Analyzer windows grouped together • System Output window at the bottom of the screen
Simulation	<p>Applies the 'Simulation' workspace layout, for use when running simulations. These windows are displayed:</p> <ul style="list-style-type: none"> • Main work area • Browser, Inspector and Execution Analyzer windows grouped together • Simulation and Simulation Events windows • Locals and Call Stack windows
DMN-Sim	<p>Applies the 'DMN-Sim' workspace layout, for use when creating or running DMN simulations. These windows are displayed:</p> <ul style="list-style-type: none"> • Main work area • Browser, Inspector and Execution Analyzer windows grouped together • DMN Simulation and DMN Expression windows
BPSim	<p>Applies the 'BPSim' workspace layout, for use when working with Business Process Simulations. These windows are displayed:</p> <ul style="list-style-type: none"> • Main work area • Browser and Inspector windows grouped together • Diagram Toolbox • Properties window • Configure BPSim window
SysML-Sim	<p>Applies the 'SysML-Sim' workspace layout, for use when working with SysML Simulations. These windows are displayed:</p> <ul style="list-style-type: none"> • Configure SysML Simulation window in main work area • Browser and Inspector windows grouped together • Diagram Toolbox • Properties window • System Output window

Workspace Tools

The commands in this list provide access to facilities for customizing and managing workspaces, menu ribbons and working sets.

Options	Description
Workspaces	<p>Displays the 'Workspaces' tab of the 'Workspaces Layout' window.</p> <p>This window allows you to select from a range of predefined workspace layouts and apply one of them, such that the application desktop displays a particular set of</p>

	windows and toolbars, arranged in a way to facilitate certain modeling activities.
My Workspaces	Opens the 'My Workspaces' tab on the 'Workspace Layout' window, enabling you to select, create and maintain the workspaces that you use, as a means of organizing all the tools appropriate to your areas of work.
My Ribbon Sets	Opens the 'My Ribbon Sets' tab of the 'Workspaces Layout' window. This tab allows you to set a filter on the ribbons and the panels in the ribbons, so as to provide a clearer focus on only the core features that you use and eliminate any distracting features outside your domain of work.
Save Workspace	Saves the current Workspace layout as a new customized Workspace.
Working Sets	Opens the 'Working Sets' tab of the 'Focus' window. These Working Sets are saved outlays of what you want opened in Enterprise Architect. Working Sets can be manually created or a capture of your current work environment.

User Layouts

The *User Layouts* list presents a list of the workspace layouts you have created yourself.

Option	Description
<empty>	This list remains empty until you have defined and saved some workspace layouts of your own.

Navigating the Model

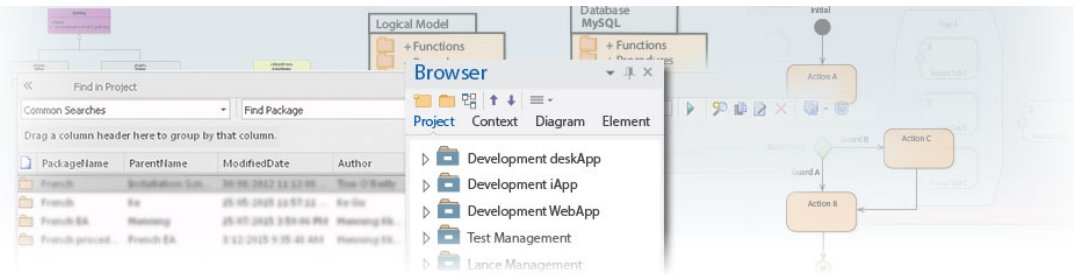

Enterprise Architect stores valuable organizational information in a repository, and over time these repositories will become large and will often contain many thousands of elements and connectors. It is critical to be able locate entities in the repository, and Enterprise Architect provides a rich set of features for this purpose.

The Browser window provides hierarchical views of the repository elements, features and diagrams; knowledge of the Package hierarchy at different levels, and more detailed lists of diagram and element content, will help you to navigate through the repository and drill into and out of Packages, locating what you are looking for. There are also Package and resources browsers that help you to find items in the repository.

A Navigator Toolbar helps you to navigate the hierarchy of Packages in the repository using a textual breadcrumb control, showing you the current Package location.

As models become larger, using the flexible Model Search function will make it easy to find an entity or a set of entities that meet defined criteria. There are a large number of built-in searches, but there is no limit to the searches that can be created and even novice users can define useful and time-saving searches.

Elements in well-formed models are articulated using relationships that create a graph of elements. The ability to traverse this graph is often termed traceability, and Enterprise Architect has a series of features such as the Traceability window that make it easy to visualize this graph of interconnected elements, bringing the repository to life.

Facilities

Facility
The use of the Browser window and Package Browser to navigate and explore your model
How Model Views provide different perspectives and 'entry points' into a model
Focusing on objects with specific characteristics, in the Focus window
Examining individual elements in the Inspector window
Finding elements and relationships using the Model Search tools and custom queries
Traceability tools to help track completeness, dependencies and other behavioral and structural relationships
Use of the Diagram List or Package Browser to view model elements in a conventional list based manner
Use of the Relationship Matrix to understand and track relationships between model elements in a spreadsheet view
Using Diagram Filters to highlight information in diagrams
Using the Traceability window to explore model dependencies

Finding and working with element Relationships

Exploring Your Model



Navigating is the ability to explore the hierarchical content of a repository, using the tree-view windows such as the 'Details' tab of the Inspector window, the Package Browser and the Traceability window, and the list-view windows such as the Package and diagram lists. There is a wide range of other views that help you to navigate through content stored in a repository, such as the Gantt Chart for exploring how elements are affected over time, and the 'Resources' tab of the Browser window that lists assets such as templates, patterns and matrices. The Navigator toolbar also shows a breadcrumb view of the Package hierarchy. These features are particularly useful when you have some familiarity with the structure of a repository, but you can also use the convenient search features to find individual objects.

Tools

Tool
The Browser window , the main interface element for exploring and navigating your model
The Package Browser - a tabular, editable view of elements in a selected Package, which can be displayed in the main workspace.
The Diagram List - a tabular, editable view of elements in a selected diagram, which can be displayed in the main workspace
Model Views provide different perspectives and 'entry points' into your model
A Diagram Slide Show displays a number of related diagrams in a presentation, for illustration and comparison of features of your model.
The Pan and Zoom window helps you to navigate around very large diagrams.
The Summary Window shows a brief, read-only summary of the general properties of the currently selected: <ul style="list-style-type: none"> • Element (including Packages) • Attribute • Operation • Test • Maintenance item • Resource

The Navigator Toolbar

The Navigator toolbar identifies the location of the Package or diagram you are currently working in, and provides options to change the focus to another level of the Package's branch, perform relevant operations on the Package, and locate other Packages in the model.

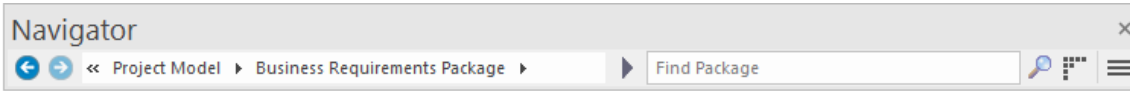

Access

Ribbon	<p>Explore > Portals > Windows > Explore > Navigator</p> <p>Start > All Windows > Design > Navigate</p>
--------	--

Navigator Toolbar Options

Icon/Option	Action
	Click on this icon to move one level further up the location path, to the current Package's parent Package. The child Package is cleared from the path.
	Click on this icon to move one level further down the Package's location path, to the child Package that was previously opened in this work session. If a child of the current Package has not been opened, the icon is not available.
<< Development Model > Login States >	<p>Displays a 'breadcrumb trail' of branch nodes under which the current Package is located. You can continue to expand the 'breadcrumb' path to show a branch of the child Packages contained within the current Package.</p> <p>A double chevron (<<) to the left of the Package path indicates that you have explored the Package branch to several levels below the current Package, and it is out of view to the left. Click on the chevron to display the current Package again.</p> <p>As you click on the last Package in a path, a list of its child Packages and diagrams displays, from which you select the next object for the path. If you click on a diagram, the diagram opens in the Diagram View. The listed diagrams include child diagrams both of the selected Package and of elements in that Package. The names of the child diagrams of elements are preceded by the parent element name.</p> <p>If you click on an expanded path node, the child nodes are closed and cleared from the path.</p> <p>As you select a Package or diagram, that branch in the Browser window is expanded and the Package or diagram you select is highlighted. This also sets the context for any tools and utilities you open to work on a Package.</p>
CustomerAdd	In this field, type the name of a Package and click on the icon to locate that Package anywhere in the model, directly using the Model Search facility.
	Click on this icon to return focus to the Start Page.

	<p>Click on this icon to display a set of buttons, each of which invokes a task or process that you can perform with the current Package as the focus or target. These tasks include:</p> <ul style="list-style-type: none"> • Highlight the Package in the condensed, Package-only hierarchy of the Find Package window • Display the Package contents in the Package Browser view • Display the Package contents in the Specification Manager • Add a Model Package to the current Package, using the Model Builder • Add a new child Package to the current Package • Add a new diagram to the current Package • Use the Model Search to locate a text string in the Package • Use the File Search to locate files associated with the current Package • Access the Portals View through which you can perform a wide range of other operations on the Package
---	--

Navigator Toolbar Context Menu

If you right-click on a Package in the 'breadcrumb trail' a context menu displays, providing a number of options for reviewing the selected Package.

Option	Action
Specification Manager	Open the Specification Manager to show the element hierarchies contained in the selected Package.
Show Gantt Chart	Open the Element View of the Project Gantt Chart, showing the elements in the Package that have resources allocated to them.
Show Contents	Open the Package Browser and display the contents of the selected Package
Go to Package	Open the 'Find Package' dialog and review the Package hierarchy of which the selected Package is a part.
Add Model	Open the Model Builder dialog, and use this to create models underneath the selected Package.
Add Package	Open the 'New Package' dialog and use this to add child Packages to the selected Package.
Add Diagram	Open the 'New Diagram' dialog and create a new child diagram under the selected Package.
Copy Path	Copy the Package path to the clipboard. You can then paste the path into a Model Mail, Model Library post or other text in your model, as a reference to the Package. You can also capture a Package path by right-clicking on the Package in the Browser window and selecting the 'Copy/Paste Copy Node to Clipboard' option.
Go To Path	Open the 'Select Package' dialog. Type or paste into the 'Path' field a Package path

you want to follow.

- If typing, use a period (.) as the separator between Package names in the path; for example:
BusinessProcedures.Accounting.Recoveries.Bad Debt Process
- If pasting, you might copy the path from a message posted through any of the communication facilities in the model, or directly from the model itself (see *Copy Path*)

Click on the OK button. The 'Navigator' path field is updated, and any Package content display you have open is refreshed with the content of the Package at the end of the path.

User Preferences

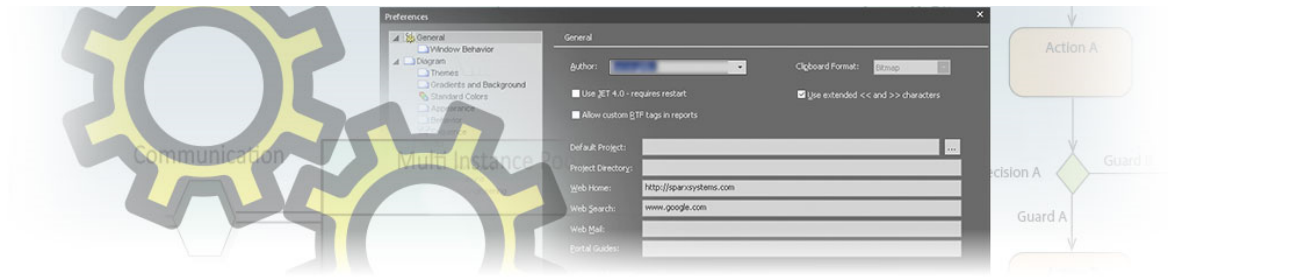

Enterprise Architect has a wide range of default settings for controlling how the application acts on and presents model structures and elements on your workstation. You can customize these settings to define your preferred behavior of the system. Most of the settings are stored in your registry and they are set for your use only, on any model you open. For a networked workplace, registry settings can be copied down to any network workstation you log in to. Otherwise, the settings control operations under your login on the current machine only.

The settings are grouped according to their actions on specific functional areas, on a number of pages of the 'Preferences' dialog.

Access

Ribbon	Start > Appearance > Preferences > Preferences
Keyboard Shortcuts	Ctrl+F9

Option Groups

Group/Page	Action
General Options	Control the behavior of the system as a whole. You can also define model-specific options (such as the default directory name for the shared files you define for an element) using the 'Manage Model Options' dialog.
Window Behavior	Set local options that determine how dockable windows display in your system.
Diagram (New Diagram Defaults)	Set the general properties of all diagrams you create.
Diagram - Themes	Create and apply display themes for all diagrams that you open.
Diagram - Gradients and Backgrounds	Select the type of background to apply to all diagrams, either a single color or a tile image, and the fill color to apply to all elements on the diagrams. You can also set a color gradient to the diagram background, the element fill, or both.
Diagram - Standard Colors	Set the display colors and background colors of objects and properties in diagrams across the system.

Diagram - Appearance	Control how elements are displayed on a diagram.
Diagram - Behavior	Control how a diagram responds to actions taken on it.
Diagram - Sequence (diagram display)	Control the appearance and behavior of Sequence diagrams specifically.
Objects (display)	Configure the properties and behaviors of elements created on your diagrams.
Links (Connector display)	Define the creation, behavior and notation of connectors on your diagrams.
Communication Colors (of Communication Messages)	Set the colors of Messages you create in Communication diagrams.
XML Specifications	Configure the settings for working with XML.
Source Code Engineering	Set general user-specific options that apply to all languages when you are generating code from models You can also define model-specific options (such as the default language in which to generate code) using the 'Manage Model Options' dialog.
Code Editors	Configure options for the system internal editor, and for the default editor for DDL scripts.
Attribute/Operations	Set the system actions on attributes and operations.
Code language specifications	Define how the system handles a particular language when generating code, setting user-specific variables such as the default source directory. You can also define model-specific options (such as the default file extensions to apply when generating code in the selected language) using the 'Manage Model Options' dialog.

General Options

You can control how the system behaves when you open a project, including setting the home directories and web pages the project refers to.

The 'General' page has a child 'Window Behavior' page for defining how dockable windows display on the system.

Access

Ribbon	Start > Appearance > Preferences > Preferences > General
Keyboard Shortcuts	Ctrl+F9 General

Control system behavior

Field/Button	Action
Author	Defaults to your Windows user name. This value is applied to the 'Author' field when you create new elements and diagrams. Optionally, type in a new Author name, or click on the drop-down arrow and select a name from the list (which contains names defined on the 'Project Author(s)' page of the 'People' dialog). When user security is enabled, this field will be populated with your <i>Firstname Lastname</i> as defined in the 'Manage Users' dialog, and it can only be modified there, not on the 'General' page of the 'Preferences' dialog.
Clipboard Format	Click on the drop-down arrow and select the graphic format in which to save images to the Microsoft Windows clipboard; Metafile has the best detail.
Default Project	Either type in the file path and file name of the project to open when you start up Enterprise Architect, or click on the  button and browse for the project.
Project Directory	Type in the default directory location for the Enterprise Architect project files you create.
Portal Guides	When you select a PDF User Guide from the User Guide Portal, the system downloads the file from the Sparx Systems website. If you have stored the User Guides in a different location, type in either the local directory path or the URL of the website into which you have moved the files.
Confirm Deletes	The checkbox defaults to selected to display a confirmation prompt whenever you delete a model component. Only clear this checkbox to bypass the prompt if you are an experienced user and have taken other measures to identify and recover from accidental deletes.
Free Sorting	Select the checkbox to allow you to manually reorganize elements within a Package regardless of element type, in the Browser window.

Show Stereotypes	The checkbox defaults to selected to display element and feature stereotype names as part of the object names in the Browser window. Deselect the checkbox to hide the stereotype names.
Sort Diagrams Above Packages	This checkbox controls whether the Browser window displays diagrams above or below the child packages within a parent package. The checkbox defaults to deselected, placing diagrams below packages. Select the checkbox to display diagrams above packages.

Window Behavior

You use the 'Window Behavior' page of the 'Preferences' dialog for setting local options that determine how dockable windows display on your system, and what Toolbars are immediately available.

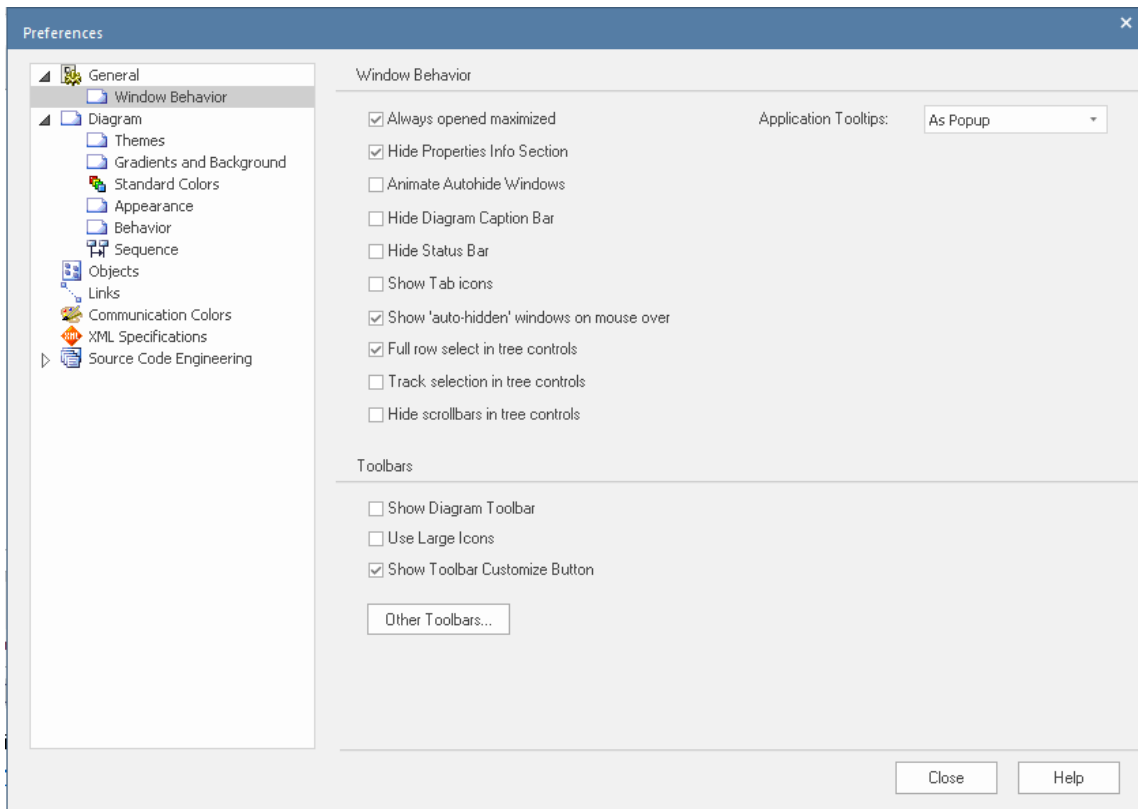

Access

Ribbon	Start > Appearance > Preferences > Preferences > General > Window Behavior
Keyboard Shortcuts	Ctrl+F9 General Window Behavior

Main Window

Select from the options listed here.

Field	Description
Always open maximized	The checkbox defaults to selected to set Enterprise Architect to open in a full-screen (maximized) window on start-up. Deselect the checkbox to set Enterprise Architect to open in a smaller window.
Hide Diagram Caption Bar	The diagram caption bar normally displays at the top or bottom of a diagram. If you prefer, select this checkbox to hide the caption bar.

<p>Hide Status Bar</p>	<p>The Status Bar normally displays at the bottom of the Enterprise Architect work area. It shows information on the current operation and certain key settings, and provides a 'zoom bar' for adjusting the scale of the diagrams you view. If you prefer to hide the Status Bar, select the checkbox.</p> <p>You can also hide sections of the information that the Status Bar shows by right-clicking on it and de-selecting any or all of the options:</p> <ul style="list-style-type: none"> • <selected Perspective name> (to hide the name of the currently selected Perspective) • Zoom Slider • Status Indicators
------------------------	---

Tree Controls

<p>Full row select</p>	<p>In a window that displays a hierarchy of model elements - such as the Browser window - clicking on an item highlights the selection. Selecting the 'Full Row Select' checkbox causes the highlight to extend across the width of the window. Deselecting the checkbox restricts the highlight to the object name.</p>
<p>Track selection</p>	<p>When this checkbox is selected, moving the cursor over an item in a hierarchy window - such as the Browser window - causes an underline to display under the element name, indicating that the item has focus and can be selected. If you deselect the checkbox, the listed items are not underlined and none have focus until they are explicitly clicked on.</p>
<p>Hide scrollbars</p>	<p>Select this checkbox to hide both vertical and horizontal scrollbars in the windows that list the hierarchical contents of the model, such as the Browser window. Clear the checkbox to allow scrollbars to display.</p>

Toolbars

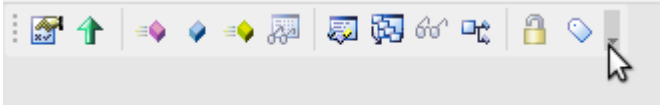
<p>Show Diagram Toolbar</p>	<p>Display the Diagram Toolbar at the top of every open diagram. Deselect this checkbox to hide the Toolbar on every diagram.</p>
<p>Use Large Icons</p>	<p>Select to show all icons on Toolbars at 32x32 pixels. Deselect to show the icons at 16x16 pixels.</p>
<p>Show Toolbar Customize Button</p>	<p>Each toolbar can have a down-arrow button on the end, which enables you to customize the toolbar options. This checkbox defaults to selected to show the down-arrow button; deselect the checkbox to hide the button, if you prefer.</p> 

Other Toolbars	Click on this button to show the 'Toolbar Customization' dialog, which allows you to quickly show and hide specific Toolbars.
----------------	---

AutoHide

Animate Auto Hide Windows	<p>If you are using windows that have been automatically hidden, they simply appear in the workspace when you move the cursor over the window tab.</p> <p>Select this checkbox to slide the windows out into the workspace when you place the cursor on the window tab.</p>
Show 'auto-hidden' windows on mouse over	<p>The checkbox defaults to selected to show hidden windows when you drag the cursor onto the window's tab using the mouse. When you move the cursor off the window, it no longer displays.</p> <p>If you deselect the checkbox, you have to left-click on the window's tab to display the window.</p>

Collaboration

Post Chats and Discussions Using	<p>Click on the drop-down arrow and select the keys that you want to use to post and save messages created in the 'Chat' tab of the Chat & Mail window, and in the 'Discuss' and 'Review' tabs of the Discuss & Review window.</p> <p>The options are 'Return' and 'Ctrl+Return'. Whichever key(s) you do <i>not</i> select can be used to move to the start of a new line when typing in text.</p>

Other

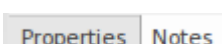
Hide Properties Info Section	<p>The checkbox defaults to selected to hide the properties information bar at the bottom of various displays such as the Properties window and 'Properties' dialog.</p> <p>Deselect the checkbox to expose the information bar.</p>
Show Tab icons	<p>Select this checkbox to show a representative icon on the name tab of each docked window.</p>  <p>Deselect the checkbox to hide these icons.</p> 

Application Tooltips	<p>When you mouse-over ribbon or toolbar options, or the options in their subordinate menus, Enterprise Architect displays a tooltip identifying the function of that option.</p> <p>You use this drop-down list to select whether to display the tooltips in the left-hand end of the Status Bar at the foot of the screen, or as a pop-up message close to the option. You can also select a third option to disable the display of tooltips.</p>
----------------------	---

Diagram Options

In order to maintain consistency in the format, layout and visibility of objects in your diagrams, you can define a number of default settings to apply to all diagrams that you display, whether you are creating them or reviewing them. You can change or reverse many of these default settings for your view of individual diagrams (whether you created them or another user created them) on the diagram 'Properties' dialog.

Access

Ribbon	Start > Appearance > Preferences > Preferences > Diagram
Keyboard Shortcuts	Ctrl+F9 Diagram

Control Diagram Setup

Field/Button	Action
Default Page Size	Show (underneath the field name) the default page size for diagrams. You set the default page size using the Page Setup button.
Page Setup	Click on this button to define the page dimensions for diagrams that you create. The 'Page Setup' dialog displays, on which you set the page size, orientation, printer paper tray, and page margins.
Print with Border	Select the checkbox to set the default to printing a border on all diagrams you have created.
Landscape	This checkbox is controlled from the 'Page Setup' dialog. When selected, any diagrams that you create default to being printed in landscape orientation.
Show Public Features Show Protected Features Show Private Features	Select any or all of the checkboxes to automatically show Class features with the scope of public, protected and/or private on the diagrams you create.
Show Diagram Notes	Select the checkbox to display, by default, the diagram details (name, parent Package, version and author) in the top left corner of any new diagram that you create. Selecting this checkbox sets the 'Show Diagram Details' checkbox to selected on the diagram 'Properties' dialog for the new diagram.
Use Opaque Diagram Labels	Select any or all of the checkboxes to specify which renditions of your diagrams should have opaque diagram labels; 'Screen' and 'Printing' are most often applicable. An opaque label is a connector or element label that, when the label overlaps the connector line or border, hides the line rather than allowing it to show through the label text.

Disable fully scoped object names	<p>Select this checkbox to disable the use of fully scoped object names for elements in all diagrams.</p> <p>A scoped object name has the format <code>MyClasses::foo</code>, where the <code>::</code> character indicates that the Class is within another namespace.</p> <p>This option automatically deselects the 'Show Namespace' option in all new diagrams and hides the 'Namespace::element Name' in each element, but does not hide the '(from 'Namespace')' label.</p> <p>Alternatively, fully-scoped object names can be disabled for a specific diagram via the diagram's display options.</p>
Allow change of Created Date	<p>Select this checkbox to allow you to change the diagram creation date on any diagram, through the diagram 'Properties' dialog.</p>
Zoom to best scale	<p>Select this checkbox to resize all diagrams that you open to neatly fit the monitor screen.</p>
Auto-pan with middle mouse button	<p>Select this checkbox to turn on auto-panning using the middle mouse button. In this case, when you hold down the middle mouse button a black compass icon displays, and as you move the cursor away from this icon the diagram scrolls in that direction.</p> <p>If you deselect the checkbox, when you hold down the middle mouse button a white compass icon displays, and as you move this icon the whole diagram moves with it across or up and down the screen.</p>
Enable Connector line jumps	<p>Defaults to selected, so that solid-line connectors show 'hoop' icons or 'jumps' when they cross, on all diagrams that you open.</p> <p>Deselect to disable line jumps so that connectors simply cross with no 'hoop' icon at the intersection.</p>
Auto Reload Changed Diagrams	<p>Select this checkbox to reload any diagrams that you have open that have been updated and saved by another user within the last 60 seconds. If you have selected this option and someone changes a diagram you have open, then:</p> <ul style="list-style-type: none"> • Any open diagram that is not currently visible (in another tab) will refresh when you return to that tab • An open diagram with no unsaved changes, which you are looking at, will just refresh • A diagram that you are updating yourself and have not saved is not reloaded but will display a message when you select to save your changes, to prompt you to select to override the other user's changes with yours or to reload the diagram and override your changes <p>This option is also available from the 'Design > Diagram > Options' icon.</p>
Scale Saved Bitmaps to	<p>You can save images of diagrams to file, suitable for using in published works, using the 'Publish > Diagram Image > Save > Save to File' ribbon option. This option prompts you to specify the file location and file format. If you select to save the files in <i>bitmap</i> format, the images are scaled to the default of 137%.</p> <p>If you prefer to use a different scale, click on the drop-down arrow and select one of the other set values between 100% and 400%. (You can also change the scale percentage for saving diagram images to file using the 'Publish > Diagram Image > Save > Scale Image' ribbon option).</p> <p>Images saved in formats other than bitmap are not scaled.</p>
Apply scale to clipboard	<p>You can also save images of diagrams to the clipboard, in either bitmap or metafile</p>

	<p>format (set in the 'Clipboard Format' field on the 'General' page of the 'Options' dialog), using the 'Publish > Diagram Image > Save > Save to Clipboard' ribbon option.</p> <p>If you have set the format to 'Bitmap', you can save the images to the clipboard scaled to the same percentage as is set for saving to file, by selecting this checkbox. When pasted into a document the diagram preserves its original size, which improves processing performance when the document is opened, scrolled, printed, saved to the database or exported to PDF.</p> <p>You cannot scale metafile images.</p>
Image Memory Limit	<p>When you generate images for document or web reports or save images to file, the memory limit for storing this image defaults to 48 MB. If the image is beyond this limit, the system starts to scale down the image.</p> <p>You can click on the drop-down arrow and select a lower or higher memory limit for the image files of your diagrams. A low memory setting means the system scales the image sooner.</p>
Diagram Frames	<p>Click on any or all of the checkboxes to specify which saved images of your diagrams will automatically include a diagram frame around them - those saved to disk, those printed out, and/or those saved to the default system clipboard.</p> <p>A diagram frame is a labeled outline around the diagram image, providing both a border and a reference. A SysML Internal Block diagram can have its own diagram frame; if that frame is selected to be shown, these Diagram Frames options are ignored for the diagram.</p> <p>These diagram frames are not the same as the Diagram Frame element in which you can enclose a diagram image or reference when you drag the diagram from the Browser window onto another diagram.</p>
Tooltips	<p>This panel defines the content of the tool-tip that is displayed when the cursor is rolled over an element on a diagram you have opened, or over the background of the diagram itself. For the tooltip to be displayed, the 'Use Info Tip (global)' checkbox must be selected in the Properties window for any diagram in the model.</p> <p>For each item of information to display as part of a tool-tip, select the checkbox against it.</p> <p>If you select the 'Notes' checkbox, consider whether the 'Max Characters' value is appropriate to represent the text of your element 'Notes' fields. The 'Max Characters' field defines the maximum number of characters of Notes text included in the tool-tip; if you want to show less text or more, reset the character limit accordingly.</p>
Close	<p>Click on this button to save the changes you have made, and to close the 'Preferences' dialog.</p>

Diagram Theme Options

It is possible to apply a theme to all diagrams in the project that you display on your workstation; that is, how the diagrams and their contents appear when you display them in the Diagram View. By using a theme you can apply specific, consistent colors, fonts, gradients, line thicknesses and background image (tile). Each design helps bring your diagrams to life with brighter colors, better contrast and stylish new designs. As you select a theme, the appearance settings are immediately applied to any diagram that you open. Enterprise Architect includes a number of basic built-in themes, which are useful to a wide range of users and are good examples of how a theme can enhance the diagrams that you have open.

You can also create your own themes, capturing the set of colors, text font, line thickness and/or gradient properties that you have currently defined in the 'Preferences' dialog, on the:

- 'Gradients and Background' page
- 'Standard Colors' page
- 'Appearance' page, and
- 'Links' page

You select or deselect a checkbox for each set of properties you want to include or exclude, from the 'Preferences' dialog pages.

Access

On the 'Preferences' dialog, select the 'Diagram > Themes' page.

Ribbon	Start > Appearance > Preferences > Preferences > Diagram > Themes
Keyboard Shortcuts	Ctrl+F9

Configure themes for Diagrams and Elements

Option	Action
Name	<p>Click on the drop-down arrow and select the theme you want to either:</p> <ul style="list-style-type: none"> • Apply as the default appearance of your diagrams • Edit (user-defined theme) • Use as the base for a new user-defined theme, or • Delete (user-defined theme)
Font	<p>Select the checkbox to include the 'User Font Face' and 'Font Size' settings from the 'Appearance' page of the 'Preferences' dialog (click on the 'Configure Default Element Fonts' button on the 'Appearance' page to set these fields).</p> <p>Deselect the checkbox to retain the previous font applied to the diagram.</p>
Color	<p>Select the checkbox to include the element, connector and diagram colors defined on the 'Gradients and Background' page and the 'Standard Colors' page.</p> <p>Deselect the checkbox to retain the previous set of colors applied to the diagram.</p>
	Select the checkbox to include the 'Default Element Border Width' from the

Line Thickness	'Appearance' page, and the 'Pen Width' (for connector line thickness) from the 'Link' page of the 'Preferences' dialog. Deselect the checkbox to retain the previous set of line widths applied to the diagram.
Gradient	Select the checkbox to apply the setting of the 'Show Gradient Fill for Paper Color' checkbox (which applies a color gradient to the background color of the diagrams you display) and the 'Gradient Fill Direction for an Element' field on the 'Gradients and Background' page of the 'Preferences' dialog. Deselect the checkbox to retain the previous color gradient settings applied to the diagram.
Background Image	Select the checkbox to incorporate the currently-set diagram background image in the theme.
Element Shadows	Select the checkbox to incorporate the currently-set element shadow setting (on or off) and color in the theme.
Save	Click on this button to either: <ul style="list-style-type: none"> • Create a new user-defined theme, or • Save changes to an existing theme The 'Diagram Theme' dialog displays for the theme name. Either: <ul style="list-style-type: none"> • Type in a name for the theme and click on the OK button to create the new theme, or • Simply click on the OK button and then click on the Yes button to save the updates to the theme under the same theme name
Delete	(Only available if a user-defined theme is selected.) Click on this button to delete the selected theme. A prompt displays for you to confirm the deletion. Click on the Yes button to delete the theme, or on the No button to cancel the deletion.
Optional Drawing Modes	Select one or both of the 'Hand Drawn' and 'Whiteboard' checkboxes if you want to apply the corresponding mode to all diagrams that you open in the model.
Close	Click on this button to close the 'Preferences' dialog. If you have edited an existing theme, this applies all changes to the theme to the diagrams you have open.

Notes

- You cannot edit or delete a built-in theme; you can use a built-in theme as the base for a user-defined theme
- A theme draws its properties from other pages of the 'Preferences' dialog, therefore if you select the 'Gradient' checkbox the theme will apply the status of the 'Show Gradient Fill for Paper Color' checkbox on the 'Gradients and Background' page, when that status might be disabled because you have applied a background tile image
- You can apply a different theme to an individual diagram, on the 'Theme' tab of the diagram 'Properties' dialog

Diagram Gradients and Background

When reviewing the diagrams in your model, you have a range of options for managing the display and appearance of the diagrams and their contents. These options include setting the color and shading of the diagram and elements, and the style of the page border of the diagram. You can also, instead of using the color wash, select a tiled background image for the diagrams you display, from a set of system-supplied images or from images that you have created or downloaded to a local system folder yourself.

Access

Ribbon	Start > Appearance > Preferences > Preferences > Diagram > Gradients and Background
Keyboard Shortcuts	Ctrl+F9 Diagram Gradients and Background

Diagram Background Options

Field/Button	Action
Tile	<p>Either:</p> <ul style="list-style-type: none"> Type in the file path for a .jpg, .bmp or .png graphics file to use as a background for all your diagrams, or Click on the Select Tile button to the right of the field and select a file (by default from the Enterprise Architect supplied tiles folder, but you can browse to any other file location for the required file) <p>The selected background is immediately applied to any diagrams you have open, and the field displays the location of the background graphic file, such as:</p> <p style="padding-left: 40px;">C:\Program Files\Sparx Systems\EA\BackgroundTiles\Aqua_03.jpg</p> <p>If you no longer want to apply a background tile to your diagrams, click on the Clear Tile button to clear the field.</p> <p>All diagrams with a background tile will include that background when saved as a Diagram Image or a copy. The tile background does not display in generated documents.</p>
Paper	<p>Click on the drop-down arrow to change the background color of the diagrams you display.</p> <p>This field is disabled if you have selected a background tile. The field is re-enabled when the file path is deleted from the 'Tile' field.</p>
Page Border Style	<p>Click on the drop-down arrow and select the option for the type of page border you want to use when displaying diagrams on your monitor. You can choose from:</p> <ul style="list-style-type: none"> Solid (the default) - pages are framed by a solid dark gray line on the screen Dash - pages are framed by a broken dark gray line Dash (with white line) - pages are framed by a broken dark gray line on a solid pale background Dot - pages are framed by a dotted dark gray line

	<ul style="list-style-type: none"> • Dot (with white line) - pages are framed by a dotted dark gray line on a solid pale background line • Chiselled - pages are framed by a thin black line bordered by a thicker dark gray line to the right or below <p>If you cannot see the page border on a diagram, right-click on the diagram and select the 'Properties' option, then make sure that the 'Hide Page Border (All Diagrams)' or 'Hide Page Border (Current Diagram)' options are not selected.</p>
Gradient	<p>Click on the drop-down arrow and select the direction of the color gradient to apply to the background color of the diagrams you display - Up or Down. You set the background color itself in the 'Paper' field.</p> <p>Select <none> to apply the background color uniformly to the diagram background.</p> <p>This field is disabled if you have selected a background tile. The field is re-enabled when the file path is deleted from the 'Tile' field.</p>

Element Fill Options

Option	Action
Gradient Fill Direction For an Element	<p>Click on the drop-down arrow and select the direction of the color gradient applied to the element fill color.</p> <p>Select <none> to apply the element fill color uniformly to the element, with no color gradient.</p>
Gradient Style for Element	<p>Click on the drop-down arrow and select the style to apply to the element fill color gradient. The options apply:</p> <ul style="list-style-type: none"> • On the left or upper edge of each element, a band of the gradient color that fades in the direction of the fill, and that has an angled line or curve on the inner boundary • On the right or lower side of each element, a band of the gradient color that fades at 90 degrees to the first-defined gradient direction <p>Select '<none>' to have a single band of color fading across the element in the fill direction.</p>
Fill	<p>Click on the drop-down arrow and select the fill color of all elements (except Screen elements and Notes) on the diagrams you display.</p> <p>You can also change the element fill color on the 'Standard Colors' page, where you can define the fill color of Screen and Notes elements as well.</p> <p>You can quickly make fill color changes using the 'Hue', 'Saturation' and 'Luminosity' fields, in combination. The 'Fill' field reflects the color changes as you make them, but having a diagram open with large elements also shows the changes immediately and very clearly.</p>
Revert	<p>Click on this button to reset the fill color to the previously saved color. If you have been testing new colors but have not closed and re-opened the 'Preferences' dialog, you can return to the color you originally changed from.</p>
Hue	<p>Click on the slider icon and drag it along the line to set the basic primary color or combination of two primary colors. The numerical value of the color (the H value in the HSL code) displays in the field to the right of the slider.</p>

Saturation	Click on the slider icon and drag it along the line to set the color saturation (the degree of grayness in the color). The numerical value of the saturation (the 'S' value in the 'HSL' code) displays in the field to the right of the slider.
Luminosity	Click on the slider icon and drag it along the line to set the color luminosity (the degree of light in the color, from none (black) to full (white)). The numerical value of the luminosity (the L value in the HSL code) displays in the field to the right of the slider.

Gradient Options

These options are ineffective if the 'Gradient Fill Direction for an Element' field is set to '<none>'.

Field/Button	Action
Tint Amount	<p>Click on the slider icon and drag it along the line to set the degree of tint in the color gradient. Moving from the left end the slider sets completely black at the top of the gradient, through no tint to completely white at the top of the gradient.</p> <p>The percentage tint displays in the field to the right of the slider, showing -50% for the left end of the slider, 0% (the default) in the center and 50% at the right end.</p> <p>To reset the Tint Amount to the system default (which is a slight, dusky gradient), click on the Default button.</p>
Fill Amount	<p>Click on the slider icon and drag it along the line to set the degree of fill of the gradient. From the left end the slider sets, effectively, no gradient (0%) through to starting the gradient immediately at one edge of the element and building right across the element (100%).</p> <p>The percentage gradient fill displays in the field to the right of the slider.</p> <p>To reset the Fill Amount to the system default (80%), click on the Default button.</p>
Suppress Child Gradients	<p>This checkbox defaults to selected, to show no gradient on child elements that are displayed on a diagram within the borders of their parent element.</p> <p>Deselect the checkbox if you prefer to show these child elements with a gradient as well.</p>

Standard Colors

On a model diagram, the objects and texts are rendered in the system default colors. You can change any of these default colors to either one of a range of standard colors, or a color that you define yourself. Another user viewing the same model diagrams will still see the diagrams in either the standard default colors or colors that user has selected for their own use.

If you define and select a 'non-standard' color for an object type, that color is shown in the color pallet whilst it is the selected color for that object type. If you then select a different color, the non-standard color is no longer available in the pallet. You can, however, define up to 16 custom colors (using the Define Colors button) that are permanently available to use in changing the appearance of individual elements through the 'Default Appearance' dialog and 'Diagram' page of the 'Preferences' dialog.

Access

Ribbon	Start > Appearance > Preferences > Preferences > Diagram > Standard Colors
Keyboard Shortcuts	Ctrl+F9 Diagram Standard Colors

Customize Diagram Element Colors

The color combo boxes on the 'Standard Colors' page help you to customize the various colors that will be used to draw elements (and their features) on all diagrams.

Step	Action
1	On the selected color combo box, click on the drop-down arrow. A 10x14 color pallet displays showing a range of standard colors, with the system default color shown above the pallet and a row of squares for custom colors underneath. If custom colors have already been defined (using the Define Colors button) they are shown in the additional row.
2	If the color you want to use is shown on the pallet, click on it to select it and to return to the 'Standard Colors' page.
3	If the color you want to use is not shown, click on the More Colors button. The 'Color' dialog displays showing the 'Standard' tab, offering a larger range of standard colors.
4	If the color you want to use is shown on the pallet, click on it to show that color in the 'New' panel and (optionally) compare it with the currently-set color in the 'Current' panel. Click on the OK button to set the selected color and to return to the 'Standard Colors' page.
5	If a suitable color is not available in the extended pallet, click on the 'Custom' tab. This contains: <ul style="list-style-type: none"> • A spectrum panel, with a 'sampler' icon; move the icon around the panel to change the color shown in the 'New' panel • A 'Luminosity' bar; move the arrow on the right up and down to change the intensity of the color shown in the 'New' panel • 'Hue', 'Sat'(uration) and 'Lum'(inosity) (HSL) fields, and 'Red', 'Green' and 'Blue' (RGB) fields; type and increment or decrement the decimal values to either:

	<ul style="list-style-type: none"> - make slight modifications to a color or - exactly define a color for which you know the HSL and/or RGB values <p>As you define the color it changes in the 'New' panel; (optionally) compare it with the currently-set color in the 'Current' panel and adjust it as necessary.</p> <p>When you have defined your color, click on the OK button to select it and to return to the 'Standard Colors' page.</p>
6	<p>As an alternative to selecting a standard color or defining a new one, you can capture a color that is used elsewhere on your current monitor screen.</p> <p>Click on the Select button to redisplay the cursor as an 'eye-dropper' icon; move this around the screen to the color you want to sample.</p> <p>Position the cursor so that the color is under the tip of the 'eye-dropper' and shown in the 'New' panel.</p> <p>Click the left mouse button to capture the color, then click on the OK button to select it and to return to the 'Standard Colors' page.</p>
7	<p>Click on the Close button to save your changes and close the 'Preferences' dialog.</p>

Elements

Element / Component	Description
Fill	<p>Define the fill color of all elements (except Screen elements and Notes) on the diagrams you display.</p> <p>This color can also be changed on the 'Gradients and Backgrounds' page, and overridden by any other fill color definition in your model, such as the Layout ribbon fill setting, element default appearance, Template Element Package or stereotype definition.</p>
Line	<p>Define the line color of all element borders on the diagrams you display.</p>
Text	<p>Define the font color of element text and labels on the diagrams you display (including Text elements).</p>
Shadows	<p>Define the color of element outline shadows on the diagrams you display (including Notes).</p>
Attributes	<p>Define the font color of attribute text in the attribute compartment of all elements on the diagrams you display.</p>
Methods	<p>Define the font color of method (operation) text in the operation compartment of all elements on the diagrams you display.</p>
Behaviors	<p>Define the color for behaviors in Activity diagrams you display.</p>
Notes	<p>Define the color of text in the element notes compartment of all elements on the diagrams you display.</p>

Note & Constraint Elements

Element / Component	Description
Fill	Define the fill color of Note and Constraint elements on the diagrams you display.
Text	Define the font color of Note and Constraint text on the diagrams you display.
Note Line	Define the line color of the borders on Note elements on the diagrams you display.
Constraint Line	Define the line color of the borders on Constraint elements on the diagrams you display.

Others

Element / Component	Description
Connector Lines	Define the line color of all connectors on the diagrams you display.
Screen Fill	Define the fill color of Screen elements on User Interface diagrams you display.
Custom Colors	Click on the Define Colors button to define a set of custom colors for you to apply to diagram elements anywhere in the model.
Hyperlinks	Define the color in which Hyperlink text will be displayed. When you mouse over a Hyperlink in the model, it will be shown in a contrasting color.
Show Project Custom Colors in Color Combo Boxes	Select this checkbox to add up to 16 defined custom colors to the end of the color selection pallets on the various object and text appearance dialogs.
Use Dark Theme Style	Select this option to apply a system-managed color theme to certain types of element (including Packages, Navigation Cells, Hyperlinks and Diagram Notes) on diagrams when a dark Theme is applied to the diagrams. The general effect is to make the element colors brighter and richer. The option also allows use of a diagram background color when saving the diagram as an image or copying it to the clipboard.

Notes

- To override the default appearance of a specific element on all diagrams on which it is found, right-click on the element and select the 'Appearance | Default Appearance' option; the 'Default Appearance' dialog displays
- To change the appearance of a specific element on the current diagram only, use the 'Style' panel of the 'Layout' ribbon

Create Custom Colors

If the standard colors available through the color palettes do not meet your requirements, you can define up to 16 custom colors that you apply to individual elements and connectors through the 'Connector Appearance' dialog and element 'Default Appearance' dialog.

By applying such custom colors within a template diagram, you can render all elements of the same type with the same custom color, for all users of the project.

If another user has a set of custom colors that you want to use, or a project manager has defined colors specifically for the project, they can export these colors to the project file and you can then import them directly as your custom color pallet. If you have your own colors in the pallet, they are overwritten by the imported set.

Access

Ribbon	Start > Appearance > Preferences > Preferences > Diagram > Standard Colors : Define Colors
Keyboard Shortcuts	Ctrl+F9 Diagram Standard Colors : Define Colors

Define your custom colors

Step	Action
1	On the 'Color' dialog, click on the Define Custom Colors » button. The 'Color' dialog is extended to provide color selection fields on the right of the dialog.
2	Click on an empty block in the 'Custom colors' pallet (or, if you are replacing a color, click on that color block in the pallet) and on the: <ul style="list-style-type: none"> 'Spectrum' panel, move the 'sampler' icon around the panel to change the color shown in the 'Color Solid' box 'Luminosity' bar, move the arrow on the right up and down to change the intensity of the color shown in the 'Color Solid' box 'Hue', 'Sat'(uration) and 'Lum'(inosity) (HSL) fields, and 'Red', 'Green' and 'Blue' (RGB) fields; type decimal values to either: <ul style="list-style-type: none"> - make slight modifications to a color or - exactly define a color for which you know the HSL and/or RGB values As you define the color it changes in the 'Color Solid' box.
3	When you have finished creating the color, click on the Add to Custom Colors button to add the color to the selected Custom Colors block.
4	Repeat steps 2 and 3 for any other custom colors you want to define.
5	Click on the OK button to close the 'Color' dialog and return to the 'Standard Colors' page of the 'Preferences' dialog.

6	<p>To make the custom colors available for your use, select the 'Show Project Custom Colors in Color Combo Boxes' checkbox.</p> <p>Up to 16 custom colors are displayed at the end of the color selection pallets on the 'Connector Appearance' dialog and element 'Default Appearance' dialog.</p>
7	<p>Click on the Close button to close the 'Preferences' dialog.</p>

Get/Set Custom Project Colors

If more than one person is working on a project, you might want to share a set of custom colors with other team members, or possibly provide special colors for use across the whole project. You would then:

- Capture the custom or project colors you have defined, in the project file, or
- Retrieve a set of colors someone else has defined, from the project file

Access

Ribbon	Settings > Reference Data > Settings > Colors > Get Project Custom Colors Settings > Reference Data > Settings > Colors > Set Project Custom Colors
--------	--

Set custom project colors in the project file

Step	Action
1	Define the custom colors on the 'Standard Colors' page of the 'Preferences' dialog.
2	Select the 'Set Project Custom Colors' option. This message displays: <i>Project Custom Colors export successful. 16 custom colors saved to the project file.</i>
3	Click on the OK button. Notify the appropriate users that the colors are available for importing.

Get project custom colors from the project file

Step	Action
1	Select the 'Get Project Custom Colors' option. This message displays: <i>Project Custom Colors import successful. 16 custom colors imported from the project file.</i>
2	The custom colors are now available at the end of the color pallets of the 'Default Appearance' dialog and 'Connector Appearance' dialog. <ul style="list-style-type: none"> • If the colors do not show, select the 'Start > Appearance > Preferences > Preferences' ribbon option and the 'Diagram > Standard Colors' page, and select the 'Show Project Custom Colors in Color Combo Boxes' checkbox

Diagram Appearance Options

It is possible to configure the appearance of diagrams and elements in your models; that is, how diagrams and their contents appear when displayed in the Diagram View. There is a wide range of options you can set to create this display configuration. As you select an option, it has immediate effect on any diagram that you have open, so you can see what the change in appearance is.

Access

Ribbon	Start > Appearance > Preferences > Preferences > Diagram > Appearance
Keyboard Shortcuts	Ctrl+F9 Diagram Appearance

Configure the Appearance of Diagrams and Elements

Field/Button	Action
Default Fonts	Click on this button to set the default text fonts to use on diagrams that you have opened yourself.
Renderer	<p>Render smooth curves and diagonal lines in diagrams, so that staggered vertical or horizontal pixels are less obvious. Click on the drop-down arrow and select the type of renderer you prefer to use:</p> <ul style="list-style-type: none"> • Basic is GDI32; it does not provide anti-aliasing and gradient fills • Enhanced-1 is parallel to Windows GDI+ but internal to Enterprise Architect; it provides anti-aliasing and gradient fills, and operates well across different platforms • Enhanced-2 is Windows GDI+; this can vary across different platforms, performing better than Enhanced-1 in some environments, and less well in others <p>Experiment with these options and see which works best for your system and requirements.</p>
Image Quality	<p>Defaults to 'High' to maximize image drawing quality for scaled and resized images on a diagram. The option does not affect the drawing of EMF or WMF images.</p> <p>This setting has an effect on processing performance of the diagram, so if a diagram has many images and performance is more important than high image quality, you can reset the field to 'Low'.</p>
Base Zoom	Click on the drop-down arrow and select the amount of magnification (zoom) to apply to all diagram contents when you open a diagram. Any subsequent Zoom options operate on the diagram content with the Base Zoom size as the starting point.
Scale view by	Click on the drop-down arrow and select the percentage (from 0 to 50, in increments of 10) by which you can automatically increase the size of all objects on a diagram you are viewing, without affecting other users reading that diagram.

	<p>You can perform the same function with the Zoom Slider on the Status bar; changes in the 'zoomed' display scale of a diagram update this field and affect any other diagrams that you open.</p> <p>This has no impact any other diagram Zoom facility in the system.</p>
Element Border Width	Click on the drop-down arrow and select the default element border width (1, 2 or 3 pixels).
Anti-aliased text	<p>Select the checkbox to force text anti-aliasing in diagrams.</p> <p>If you deselect the checkbox, the system applies the MS Windows default setting. Therefore, if you do not want to use anti-aliasing, ensure that the Windows anti-aliasing default is also set to OFF.</p>
Use extended « and » characters	<p>The checkbox defaults to selected to apply the guillemet characters to stereotype names; recommended for double byte character sets.</p> <p>Deselect the checkbox to hide the guillemet characters.</p>
Invert rotated text for metafiles	Select the checkbox to use a different text format when external metafile readers are causing issues.
Print in Color	<p>Select the checkbox to print your diagrams in color.</p> <p>Deselect the checkbox to print the diagrams in black and white.</p>
Document with background color	Select this checkbox to apply the background color of the current theme to all diagram images generated in the RTF Generator, instead of the standard white.
HTML Report with background color	Select this checkbox to apply the background color of the current theme to all diagram images generated in the HTML Generator, instead of the standard white.
Use Element Group Style	<p>Select the checkbox to apply a different fill color to each object type, with objects derived from a common element having the same color (for example, Object, Boundary, Control and Lifeline elements are the same color). The Group Style colors are system defined.</p> <p>Overrides all other settings for element fill colors.</p>
as Border	<p>This option is available when the 'Use Element Group Style' option is selected. It toggles the group style colors between the element fill and the element border:</p> <ul style="list-style-type: none"> • Selected - the element borders are shown in the different 'Group Style' colors, whilst the element fill is the standard 'Fill' color set on the 'Standard Colors' page • Unselected - the element borders are shown in the standard 'Line' color set on the 'Standard Colors' page, while the elements have the different 'Group Style' fill colors
Element Shadows On	<p>Select the checkbox to display a shadow around the bottom and right edges of each element in a diagram, including:</p> <ul style="list-style-type: none"> • Checklist elements • Elements in Info View notation • Constraints • Interaction Occurrences on Sequence diagrams • State/Continuation elements on Sequence diagrams • Instanced Actors on Sequence diagrams

Connector Shadows On	Select the checkbox to display a shadow beneath the connector line and arrow heads of each connector on this diagram.
Suppress shadows for child elements	This checkbox defaults to selected, to show no shadows on the edges of child elements that are displayed on a diagram within the borders of their parent element. Deselect the checkbox if you prefer to show these child elements with edge shadows as well.
Bold Element Names	Select the checkbox to display element names in bold text.
Italic Note Element Text	Select the checkbox to display the text of Note elements, Text elements and Note compartments in italics. This does not affect the text displayed in Notes fields or the Notes window.
Fit text to element	Select this checkbox to compress the text inside the element in a font size that allows all text to fit inside the element field.
Round corners	Select the checkbox to soften the corners of all elements that have a rectangular appearance, so that they have rounded corners.
Hand Drawn Mode - Font	Click on the drop-down arrow and select the font to be used in any diagram you display that has the 'Hand Drawn' option selected.
Default	Click on this button to re-set the font you see used in hand-drawn diagram mode to the system default (Segoe Print).
Italic	For diagrams displayed in Hand Draw mode, select this checkbox to display text in italics.
Use Watermark	Select the checkbox to add a watermark to any diagrams that you print.
Text	Type in the text to use as watermark text. If the 'Use Watermark' checkbox is selected, this text is displayed on any diagrams that you print.
Close	Click on this button to save the changes you have made, and to close the 'Preferences' dialog.

Set User Default Fonts

A diagram in your model uses a standard font that is applied to any diagram displayed in any model. You can override this by setting a user-specific font that applies to any diagram that you display in any model.

You can also define Model Fonts that apply to any diagram that any user displays within the model; the Model font overrides the User font, to ensure that all members of the project team have a consistent and coherent view of the model. This avoids the problem of one user creating a diagram in a small font, and another user trying to view it in a larger font, which distorts the diagram.

Access

Ribbon	Start > Appearance > Preferences > Preferences > Diagram > Appearance : Default Fonts
Keyboard Shortcuts	Ctrl+F9 Diagram Appearance : Default Fonts

Control Default Diagram Fonts

Field/Button	Action
Font Face	Click on the drop-down arrow and select the font typeface to apply to your diagrams if no model font is specified.
Font Size	Click on the drop-down arrow and select the font size to apply to your diagrams if no model font size is specified.
Restore Defaults	Click on this button to restore the system defaults to the user 'Font Face' and 'Font Size' fields.
OK	Click on this button to close the dialog and save your changes.
Cancel	Click on this button to close the dialog and discard your changes.

Notes

- In the Corporate, Unified and Ultimate Editions of Enterprise Architect, if security is enabled you must have 'Manage Project Settings' permission to set, change or clear the 'Model Font' fields
- User fonts are overridden by specifically-defined element fonts, so that the element is viewed as designed regardless of the model or user defaults; to define the font for a specific element, right-click on the element in a diagram and select the 'Appearance | Set Font' option
- If you cannot read the diagrams because the default font makes the objects and text too small, you can scale up all objects (that is, all diagram displays) to a more readable size for you only; the objects are not scaled up for other users
Everything on the diagram is enlarged to the same extent, so it remains in proportion and readable; to do this, return

to the 'Diagram Appearance' page of the 'Preferences' dialog and enter a suitable percentage value in the 'Scale view by' field

Diagram Behavior Options

As you create and edit diagrams in your model, the system can respond in different ways to the types of object you are adding to a diagram. You can configure a range of options to control what response the system makes to the object you are adding or the action you are performing.

Access

Ribbon	Start > Appearance > Preferences > Preferences > Diagram > Behavior
Keyboard Shortcuts	Ctrl+F9 Diagram Behavior

Control Diagram Behavior

Field/Button	Action
Auto Instance	<p>Select the checkbox to automatically create object instances when dragging certain element types - such as Class and Component - from the Browser window onto the diagram, with the dragged element as the classifier.</p> <p>Deselect the checkbox to paste the element as a link.</p> <p>This option has no effect on Sequence diagrams.</p>
Instance has Classifier style	<p>Select the checkbox to automatically apply the classifier style of the element from which an instance is instantiated, when the instance is created either through the 'Paste Element' dialog or when 'Auto Instance' is selected.</p> <p>The classifier style is the default appearance of the classifier, such as fill color and text font.</p>
Show Life Lines	Select the checkbox to adjust the alignment of life lines for Sequence elements.
Layout uses all relations	<p>Select the checkbox to automatically take connectors of all types into account when you lay out the diagram; deselect the checkbox to ignore Association connectors in automatically laying out the elements.</p> <p>The elements with Association connectors are moved as if they do not have those relationships, although the connectors themselves are still depicted on the diagram.</p> <p>This option acts through the 'Design > Diagram > Manage > Properties > Diagram : Set Layout Style' option, and through the 'Digraph' option of the Layout Tools window ('Layout > Tools > Diagram Layout > Open Diagram Layout Tools').</p>
Auto Save Changes	<p>Select the checkbox to automatically save your changes as you work. No prompts are displayed asking you to save the changes.</p> <p>Deselect the checkbox to display prompts to save your changes when you attempt to close the diagram without having saved it.</p>
Show 'Hidden' Parents	Select the checkbox to list each element's parent elements that are not already part of the diagram, in the top right corner of the element in the diagram.

	Deselect the checkbox to not list the parent elements.
Show Linked Items in Package	<p>Select the checkbox to include external elements in the Package contents list in a Package element on a diagram. For this to take effect, the 'Package Contents' checkbox must be selected on the 'Elements' tab of the 'Properties' dialog for the diagram.</p> <p>Deselect the checkbox to omit external elements from the list.</p>
Show Package Item Scope	<p>Select the checkbox to display the scope indicators (such as +, # and -) against the elements in the contents list within a Package element. For this to take effect, the 'Package Contents' checkbox must be selected on the 'Elements' tab of the 'Properties' dialog for the diagram.</p> <p>Deselect the checkbox to hide these indicators in the list.</p>
Shift-Mouse Autoscroll	Select the checkbox to enable you to autoscroll around diagrams by pressing and holding Shift and pressing the middle mouse button while you move the mouse.
Use Automatic SubActivities	Select the checkbox to automatically create a new Structured Activity element when you drag one Activity diagram from the Browser window onto another Activity diagram, and select the 'Hyperlink' option.
Auto Group Elements	<p>Select the checkbox to also move contained (child) elements when you are moving their container (parent) elements. Deselect the checkbox to move the container elements independently.</p> <p>You can toggle to the opposite setting of this option when moving an element on a diagram, by pressing or tapping the Alt key.</p>
Always Highlight Context Element	<p>Select the checkbox to show a hatched border around any element when you select it, along with the tracking handles (see <i>Tracking Handle Size</i>).</p> <p>Deselect the checkbox to show only the tracking handles when you select an element.</p>
Objects Snap to Grid	<p>Select the checkbox to make all elements on a diagram always align with the nearest grid point.</p> <p>Deselect the checkbox to position elements at a precise point regardless of the grid.</p>
Show Grid	<p>Select the checkbox to display the grid points as pale gray dots. If you specify a large grid size the grid points can be hard to see.</p> <p>Deselect the checkbox to hide the grid points.</p>
Grid Size	<p>If you have selected the 'Objects Snap to Grid' checkbox, type in the separation of the grid points, in pixels.</p> <p>If you deselect the 'Objects Snap to Grid' checkbox the value is grayed out, but it remains in the field and is applied again if you re-select the checkbox.</p>
Auto Tidy	Select the checkbox to automatically tidy line angles for custom connectors; this 'nudges' the custom line into horizontal and vertical increments.
Tidy line gap	Type in the maximum distance, in pixels, that the 'Auto Tidy' option can adjust the end point of a non-orthogonal line to make it orthogonal, for custom connectors.
Alias only	Select the radio button to display, on elements with aliases, the alias instead of the element name.

	This option and the next two options take action on diagrams for which the 'Use Alias if Available' checkbox is selected on the 'Properties' dialog for the diagram.
Alias and Name	Select the radio button to display, on elements that have aliases, both the element name and the Alias in the format '(Alias) name'.
Use alias field for role	Select the checkbox to use the Alias property of instances of elements to show the Role property.
Enable Presentation Mode	Select the checkbox to display your unlocked diagrams in Presentation Mode. Locked diagrams are automatically displayed in this mode. In Presentation Mode, when you click on an element on the diagram the element is highlighted with a solid colored border, the color being identified in the 'Highlight' field. This provides a more visually appealing highlight of any element you might be discussing in a presentation. In Presentation Mode, the 'tracking handles' are hidden.
Show Presentation Logo	Select this checkbox to display the Enterprise Architect logo down the right-hand edge of diagrams - this is very useful to add software identification in presentations, but also during work sessions.
Highlight	Click on the drop-down arrow and select the color in which to highlight the borders of a selected element both in Presentation mode and when the 'Rect Style' field is set to 'Thin'. The color is also applied to element tracking handles when the 'Handle Color' option is set to 'Use Highlight'. You can select either: <ul style="list-style-type: none"> • One of the available colors • The More Colors button, or • (If you have previously changed the color) the Default color button (Aqua) The More Colors button displays the 'Colors' dialog, from which you can select a preset color from the 'Standard' tab or define a custom color on the 'Custom' tab. Click on the OK button to apply the new color as the highlight for selected element borders.
Handle Color	Click on the drop-down arrow and select the fill color of the 'size change handles' or 'tracking handles' on an element, connector or label in a diagram. These display when you click on the object to select it. <ul style="list-style-type: none"> • White • Light Gray • Dark Gray • Black or • Use Highlight - applies the color you selected in the 'Highlight' field, so the tracking handles and selection border are the same color
Rect Style	Click on the drop-down arrow and select the thickness of the hashed selection outline. You can select from: <ul style="list-style-type: none"> • 'Normal' - the hashed outline is thick and obscures the highlighted border of the element • 'Thin' - the hashed outline is thin and not apparent against the highlighted element border
Handle Position	Click on the drop-down arrow and select the position of the 'tracking handles' on

	the object outline - either Outside the outline or Inside. Alternatively, if you do not want 'tracking handles' to display at all, select the 'Hidden' option.
Handle Size	<p>Click on the drop-down arrow and select the size of the 'tracking handles' from the list.</p> <p>You can select:</p> <ul style="list-style-type: none">• Small (the default, 8 pixels)• Medium (12 pixels), or• Large (16 pixels) <p>If 'Enable Presentation Mode' is selected, the 'tracking handles' are hidden. You can still expand or contract the element by dragging on the corners, ends or mid-points of the object.</p>
Reset BPMN Prompts	<p>Working on a BPMN 2.0 diagram can result in certain prompts being displayed, which you can hide by selecting the 'Do not show this message again' checkbox on each prompt.</p> <p>Click on this Reset BPMN Prompts button to clear that checkbox so that the prompts are again displayed.</p>
Close	Click on this button to save your changes and close the 'Preferences' dialog.

Notes

- If you have a diagram open when you reset any of these diagram behavior options, you might need to close the diagram and open it again to see the effect

Sequence Diagram Options

When you are modeling using Sequence diagrams, there are a number of rendering features that are specific to that diagram type, such as the focus of the control indicator. You can define default settings for these features, in addition to the more-general diagram settings that you define on the other diagram pages of the 'Preferences' dialog.

Access

Ribbon	Start > Appearance > Preferences > Preferences > Diagram > Sequence
Keyboard Shortcuts	Ctrl+F9 Diagram Sequence

Control Sequence diagram behavior

Field/Button	Action
Default page layout is Landscape	Select the checkbox to set the default orientation of your Sequence diagrams to landscape.
Show Sequence Numbering	Select the checkbox to display sequence numbers against the Sequence Messages on the diagrams. (This option has immediate effect.)
Assume right to left messages are Return	Select the checkbox to automatically render new Messages passing from right to left as Return Messages.
Default concurrency is Asynchronous	Select the checkbox to set the default concurrency for Sequence Messages to Asynchronous. Deselect the checkbox to set the default concurrency to Synchronous.
Enable tooltips when re-ordering messages	Select the checkbox to display a tool-tip when you attempt to move one Message above or below another. The tool-tip is to remind you that to swap the Message positions, and thus re-order the Messages, you must hold down the Alt key. If you do not hold down the Alt key the selected Message will move close to the next Message but will not go past it. To avoid displaying the tool-tip, deselect the checkbox. This is only advisable if you are familiar with the requirement to use the Alt key.
Width	Click on the drop-down arrow and select the line width (in points, between 0 and 20) of the 'focus of control' rectangle (the body at the start and end of a Message, on the Lifeline). (This option takes effect when a new element is added, an existing element is repositioned, or the diagram is closed and re-opened)
Assume message returns	Select the checkbox to set implicit Return Messages when none are explicitly drawn (recommended). Deselect the checkbox to use Return Messages only when they are explicitly

	created.
GarbageCollect	Select the checkbox to automatically truncate the Lifelines for elements that have a defined lifecycle, by drawing an X after the last Message (that is, assume garbage collect rather than explicit delete).
Name	<p>Click on the  button to display the MS Windows 'Font' dialog, and define how the caption bar text (at the top of the Sequence diagram) is rendered. The caption bar shows each element name immediately over its element in the diagram.</p> <p>This feature is particularly useful for non-English character sets.</p> <p>Changes take effect immediately after the 'Preferences' dialog is closed.</p>
Size	<p>Click on the drop-down arrow and select the font size of the caption bar text.</p> <p>This overrides the font size set in the MS Windows 'Font' dialog.</p>
Use System	Select this checkbox to override (but not overwrite) the 'Name' and 'Size' settings with the system default heading font definition.
Close	Click on this button to save the changes you have made, and to close the 'Preferences' dialog.

Object Display Options

In modeling with elements, you can configure the standard contents of the elements you create and view and, in diagrams, how they are rendered and how the system responds to actions you take on them.

Access

Ribbon	Start > Appearance > Preferences > Preferences > Objects
Keyboard Shortcuts	Ctrl+F9 > Objects

Control element appearance and behavior

Field/Button	Action
Version	Type in the default version number or code for new elements.
Phase	Type in the default phase number or code for new elements.
Highlight References	Select the checkbox to highlight parameters in operations that are passed by reference rather than value.
Reference Char(s)	Type in a character or character string to act as the reference.
Prefix/Suffix	Select the appropriate radio button to display the 'Reference Char(s)' value as either a prefix or a suffix on the operation parameter.
Warn about spaces in class names	Select the checkbox to display a warning message when a Class, operation or attribute name has embedded spaces (which can cause coding problems). Deselect the checkbox to hide such messages.
Classes honor analysis stereotypes	Select the checkbox to show Classes as their stereotype; for example, if a Class is stereotyped as a Boundary, it appears as a Boundary rather than a Class. Deselect the checkbox to show the element as its base type; that is, as a Class.
Show stereotype icon for requirements	Select the checkbox to show a code letter in the top right corner of Requirement (E, for external), Change (C) and Issue (I) elements. Deselect the checkbox to hide the indicator letter.
Support for Composite Objects	Select the checkbox to: <ul style="list-style-type: none"> • Display a hashed border within a valid parent element when you drag a potential child element onto it in a diagram • Automatically embed the child element in their parent element in the model, when you drag and drop the child element onto the parent element in a diagram • Automatically disengage the child element from the parent (break the child-parent relationship) in the model when you drag the child element out of

	<p>its parent element</p> <p>Deselect the checkbox to not display the hashed border and to not embed the child element in the parent in the model.</p>
Auto-resize marks diagram 'dirty'	<p>Select the checkbox to set auto-resizing of elements as an unsaved change to the diagram (displaying an asterisk on the diagram tab), so that you must manually save the diagram to protect the change.</p> <p>Deselect the checkbox to automatically save autosizing changes.</p>
Highlight {abstract} elements	<p>Select the checkbox to indicate, on a diagram, Classes set as abstract by displaying the tag <i>{abstract}</i> below and to the right of the Class name.</p>
Allow elongated Use Cases	<p>Select the checkbox to allow Use Cases or Use Case extension points to elongate to accommodate long names.</p> <p>If you deselect the checkbox, Use Case re-sizing is proportional and the 'make same height/width' menu options are blocked.</p>
Show status colors on diagrams	<p>Select the checkbox to display color coding in Requirement, Change and Issue elements on all diagrams.</p> <p>Deselect the checkbox to display the status bands and element shadows in the standard fill and shadow colors. You can, however, select an option in report generation to still show the status colors in diagrams in the report.</p> <p>You can increase the range of element types on which to use status color coding, through the 'Status' page of the 'General Types' dialog ('Settings > Reference Data > Model Types > General Types').</p>
Copy inheritance links on duplicate	<p>Select the checkbox to duplicate Inheritance and Realization connectors when you copy their elements.</p>
Show buttons for selected Object on diagram	<p>Select the checkbox to enable the display of the floating toolbar buttons to the right of an object when you select it.</p>  <p>Deselect the checkbox to not display these toolbar buttons or element icons.</p>
Hide diagram element paste as new dialog	<p>Select this checkbox to prevent the 'Paste as New' dialog from displaying when you copy and paste elements between diagrams; the copied element is pasted as a new element with the same name.</p> <p>Clear the checkbox to allow the dialog to display, so that you can change the element name and include existing connectors in the paste operation.</p>
Hide private inherited features	<p>When this option is selected, elements on diagrams will only show inherited features (attributes, operations and receptions) with public, protected or package scope.</p>
Show «column» stereotype	<p>Select the checkbox to show the «column» stereotype as a heading in Table elements, when data modeling.</p> <p>Deselect the checkbox to just display the column names without the «column» heading.</p>
	<p>Select the checkbox to extend levels of complexity to five levels in the 'Complexity'</p>

Extend Complexity	<p>field in the element 'Properties' dialog:</p> <ul style="list-style-type: none"> • 'Easy' • 'Medium' • 'Difficult' • 'Extreme' • 'Unknown' <p>Deselect the checkbox to restrict the field to three options (omitting 'Extreme' and 'Unknown').</p>
UML 1.5 Components	<p>Select the checkbox to perform your modeling using UML 1.5 components (Enterprise Architect versions from 4.0 onwards default to using UML 2.x).</p>
Show State Compartment	<p>Select the checkbox to show, in a State element, the State compartment divider under the State name.</p>
Show Duplicate Tags	<p>Select the checkbox to enable duplicate tag names to be shown in the element Tagged Values compartment and in the 'Tags' tab of the Properties window for the element.</p> <p>The system defaults to hiding duplicate tag names, to avoid displaying inherited and overridden Tagged Values. It is useful to display the duplicate tags when you are revising them; for example, when you are adding namespaces and labels in ODM.</p>
Group Operations by Stereotype	<p>Select the checkbox to group an element's operations by their stereotype, in the element's operations compartment on the diagram.</p> <p>The order in which the stereotypes are listed is determined by the order of the operations in the 'Operations' page of the Features window for the element - if operation AA with stereotype Z is the first in the operation list, stereotype Z is first in the stereotype list.</p> <p>Deselect the checkbox to list the operations ungrouped, in the order in which they appear in the Features window for the element.</p>
Group Attributes by Stereotype	<p>Select the checkbox to group an element's attributes by their stereotype, in the element's attributes compartment on the diagram.</p> <p>The order in which the stereotypes are listed is determined by the order of the attributes in the 'Attributes' page of the Features window for the element - if attribute AA with stereotype Z is the first in the attribute list, stereotype Z is first in the stereotype list.</p> <p>Deselect the checkbox to list the attributes ungrouped, in the order in which they appear in the 'Attributes' page for the element.</p>
Sort Features Alphabetically	<p>Select the checkbox to list element features of each type alphabetically. Features include attributes, operations, tags, constraints and Test Cases.</p> <p>Deselect the checkbox to list the features in the order in which they are defined (if not alphabetical) in the corresponding dialog or window for the feature.</p> <p>To observe the effects of selecting or deselecting the checkbox, you must close the diagram and reload it.</p>
Disable spelling	<p>Select the checkbox to turn off automatic spell checking.</p> <p>Deselect the checkbox to resume automatic spell checking.</p> <p>The spelling checker operates on the view, dialog or window where you initially enter the text strings.</p>

Show invoked Activity name (SysML)	For SysML diagram types. Select the checkbox to show CallBehaviorAction names as 'Action:Activity'. Clear the checkbox to show the names as 'Action'.
Show invoked Activity name (UML)	For UML and other non-SysML diagram types. Select the checkbox to show CallBehaviorAction names as 'Action:Activity'. Clear the checkbox to show the names as 'Action'.
Advanced	Click on this button to specify which types of element should be listed in document reports and in diagram Packages. Some types of element do not appear in Packages and in document output by default. You use this facility to include such types.
Close	Click on this button to save the changes you have made, and to close the 'Preferences' dialog.

Connector Display Options

It is possible to configure a number of settings that control the creation, behavior and notation for the connectors that you define in your diagrams.

Access

Ribbon	Start > Appearance > Preferences > Preferences > Links
Keyboard Shortcuts	Ctrl+F9 Links

Control connector appearance and behavior

Field/Button	Action
Edit Connector on New	Select the checkbox to automatically open the connector 'Properties' dialog each time you create a new connector on a diagram. Deselect the checkbox to simply create connectors without displaying the 'Properties' dialog to assign a name or properties.
Association default = source -- > target	Select the checkbox to automatically set the direction of new Associations, flowing from source to target element (that is, with an arrow head at the target end). Deselect the checkbox to create Associations with no direction (no arrowhead on the connector line.)
Generalization link style Default = Tree	Select the checkbox to show Generalizations in vertical tree-style, forming a hierarchy where multiple links to elements exist. Deselect the checkbox to create Generalizations in Auto Route style.
Shade Qualifier boxes	Select the checkbox to lightly shade all Qualifier boxes on Associations in the diagrams you open (see <i>Suppress Qualifier Boxes</i>). Deselect the checkbox to prevent shading of the Qualifier boxes.
Draw Aggregations Reversed	Select the checkbox to draw Aggregate and Composite connectors from target element to source element (the diamond on the source end of the line). Deselect the checkbox (the default), to draw these connectors from source to target (the diamond on the target end of the line).
Prompt on connector deletes	Select the checkbox to display a prompt before deleting connectors, offering the choice of hiding the connector on the diagram or deleting it completely. If you deselect this option, the delete operation defaults to the last-set option on the dialog.
Suppress Link Constraints	Select the checkbox to hide any constraints set on connectors in the diagrams you open. Deselect the checkbox to allow the constraints to display on the connector lines.

Suppress Qualifier boxes	Select the checkbox to hide the qualifiers (in their boxes) on Association connectors. Deselect the checkbox to show the qualifiers on the diagrams you open.
Show Uses arrowheads	Select the checkbox to show an arrowhead on the target end of each Use connector in a Use Case diagram. Deselect the checkbox to show the connector as a simple line.
Show 'Override Operation' dialog on new connector	Select the checkbox to show the 'Override Operation' dialog automatically when adding Generalization and Realization connectors between Classes and Interfaces, if the target element has features that can be overridden.
Suppress ' + ' Role Scope	Select the checkbox to hide the 'Public' indicator (+, when Access = Public in the connector role properties) of the source and/or target role on a connector. Deselect the connector to allow the + symbol to display. When changing this setting, you might need to reload the diagram to see the change take effect.
Strict Connector Syntax	Select this checkbox to check that each new connector complies with UML, BPMN 2.0 and SysML 1.2 & 1.3 syntax as you add it, and to enforce compliance.
Enable	Select the checkbox to enable the Quick Linker, showing the Quick Linker arrow when you click on an element on the diagram. Deselect the checkbox to hide the Quick Linker arrow and make the Quick Linker unavailable.
Show Help	Select the checkbox to add a 'Help' option at the end of the Quick Linker menu, to display the <i>Quick Linker</i> Help topic.
Pen Width	Click on the drop-down arrow and select the default connector line width (between 1 and 4 pixels).
Routing	Click on the drop-down arrow and select the default connector style for new connectors (Direct, Routed or Custom).
Exact placement	Select this radio button to set the orientation of the dashed guide line for new connectors to the exact point on the element you drag from and the exact position of the cursor as you drag to the target element. This option enables the 'Force perpendicular line' checkbox.
Center to center	Select this radio button to set the orientation of the dashed guide line for new connectors to anchor on the center of the source element and, as you approach the target element, the center of that element. The guide line displays both when you are dragging the Quick Linker arrow and when you have dragged a connector icon from the Diagram Toolbox.
Force perpendicular line	Select this checkbox to set the orientation of the dashed guide line for new connectors to a perpendicular line between the source and target element edges, wherever this is possible. You can toggle between this effect and the Exact Placement effect by holding [Ctrl] as you move the cursor between the source and target elements.

Close	Click on this button to save the changes you have made, and to close the 'Preferences' dialog.
-------	--

Notes

- For the 'Draw Aggregations Reversed' option, all tools have the parent as the target and the child as the source of the connector, which is a requirement of UML; only the direction in which you drag the mouse to draw the connector is changed

Communication Message Colors

Communication diagrams illustrate how components interact and exchange information in a process. They have a large number of messages that indicate the timing or sequence of events in the communication process. You can define the sequence of these messages using sequence numbers, which also help you to group messages within a stage in the sequence. To help make the sequence easier to see at a glance, you can also:

- Select to display the messages in color
- Set a color for each group of messages

Access

Ribbon	Start > Appearance > Preferences > Preferences > Communication Colors
Keyboard Shortcuts	Ctrl+F9 Communication Colors

Notes

- Select the 'Use Communication Message Coloring' checkbox to turn on message coloring in the Communication diagrams you open; when you select this option, Communication messages display in different colors depending on the sequence group they belong to on the diagram - for example, messages 1.n are black, 2.n are red and 3.n are green
- Click on the down arrow in the color field for each numerical message group and click on the color to set for that group; if you have more than eight groups in the sequence the color pattern repeats, so group 9 messages are the same color as group 1 messages, and group 10 messages are the same color as group 2 messages
- Click on the Close button to save the changes you have made, and to close the 'Preferences' dialog

XML Specifications

Many of the model development and management tasks you perform operate either directly or indirectly with XML. You can set defaults on a number of settings to standardize the way in which you use XML in your own modeling activities. You can override several of these settings on any specific XMI import or export, especially when publishing a model Package in XMI to another modeling language or tool.

Access

Ribbon	Start > Appearance > Preferences > Preferences > XML Specifications
Keyboard Shortcuts	Ctrl+F9 XML Specifications

Notes

- If 'Export Alternate Images' is set, and you have Packages in your model under Version Control, then any alternative images used in those Packages are also exported to the Version Control repository when you check in the Packages; in this case, you would only select the checkbox if the alternative images are subject to frequent change. Otherwise, do not select this option and instead use the 'Settings > Model > Transfer > Export Reference Data' and 'Import Reference Data' ribbon options to manage alternative images.

Set XML Specification Options

Field/Button	Action
Editor	<p>Specify the default editor for reviewing any XML documents you open within the system. Either:</p> <ul style="list-style-type: none"> Type in the location of the editor .exe file, or Click on the  button and browse for the location
Code Page	<p>Defaults to windows-1252; if you do not want to use this Code Page, type in your preferred code page reference.</p> <p>Setting a null encoding string results in the encoding tag being entirely omitted from the XML output.</p> <p>Click on the Default button to restore the setting to the default Code Page.</p>
Format XMI Output	<p>Select the checkbox to set formatting of your XMI output into human-readable form as the default.</p> <p>Deselect the checkbox to show the XMI as unformatted code.</p>
Use DTD	<p>Select the checkbox to default to using a Data Type Definition (DTD) in your XMI imports and exports. A DTD validates the correctness of the model and checks that no syntactical errors have occurred.</p> <p>Deselect the checkbox to set the default to not using a DTD.</p>

Export Diagrams	Select the checkbox to default to including diagrams when you export XML to another format or tool.
Export Alternate Images	Select the checkbox to export any alternative images used in the model when you export to XML.
Validate XMI against Schema/DTD	Select the checkbox to validate the XML format against the schema or Data Type Definition when loading an imported XML file.
Import using single transaction	<p>Select the checkbox to make all XMI import operations and all Paste Package from Clipboard operations default to being performed within a single transaction.</p> <p>Deselect this checkbox to make all XMI imports and paste Package operations default to being performed data item by data item, so that one failure does not block the whole operation (recommended for large imports/copies).</p> <p>In either case, in any specific XMI import operation the setting can be overridden.</p>
Write Log	<p>Select the checkbox to write the execution activity to a log file when you import or export XMI.</p> <p>Deselect the checkbox to not record the activity of the import or export to a log file.</p>
Export Diagram Images	Select the checkbox to export diagrams as images when you export to XML.
Image Type	If you select the 'Export Diagram Images' option, click on the drop-down arrow and select the image format to export to. Select from metafile, bitmap, .gif, .png and .jpeg.
Create placeholders for missing External References during XMI 1.1/2.1 and Native File Import	<p>Select the checkbox to show, during the import of an Enterprise Architect-exported XMI 1.1/2.1 or Native XML/XEA file, any missing:</p> <ul style="list-style-type: none"> • Diagram elements, using a Boundary element as a placeholder • Diagram connectors, using a Dependency connector as a placeholder <p>When importing an Enterprise Architect-exported XMI 1.1/2.1 or Native XML/XEA file with cross-Package references, use this option to visually show the diagram items that are not yet in the model.</p> <p>A sample scenario would be, as shown here, exporting 'Package2' to 'XMI 1.1' from 'Master.EAP' and importing it into 'New.EAP' - the Classes 'Class1' and 'Class2' and the connector between them are shown using a placeholder on the diagram 'Package2'.</p>

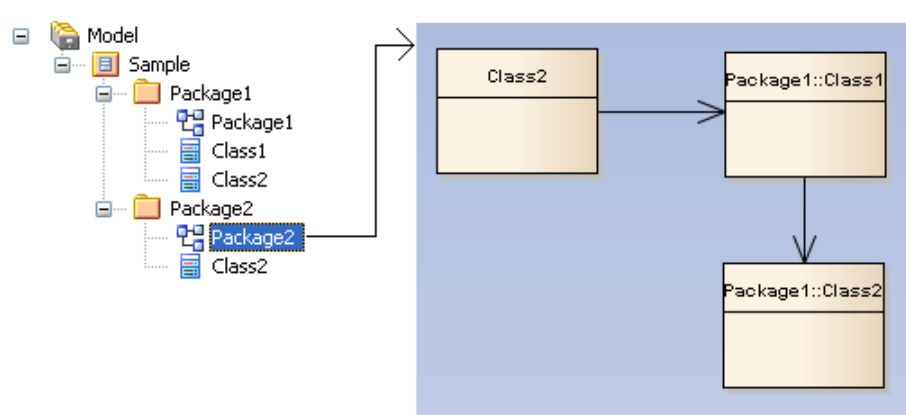
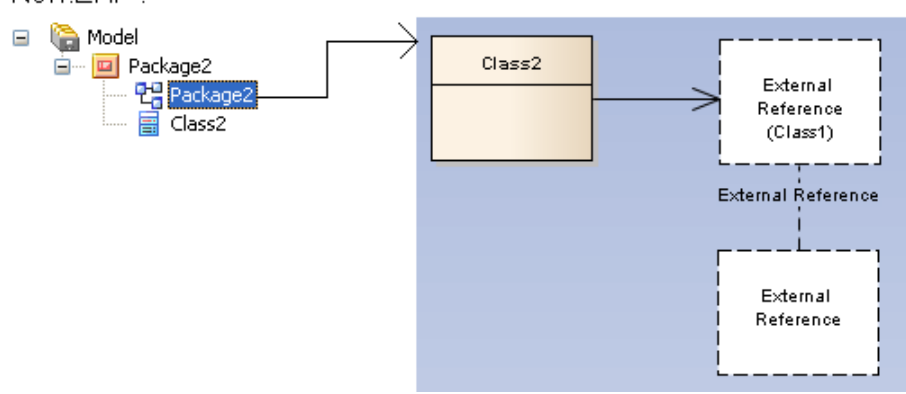
	<p>Master.EAP :</p>  <p>New.EAP :</p>  <p>If the file is for a Package under Package Control or Version Control, and this checkbox is not selected, it is overridden if the 'For all packages, create placeholders for external references' checkbox is selected on the 'Version Control Settings' dialog and/or 'Package Control Options' dialog.</p>
<p>Prefix Enterprise Architect Tagged Values in XMI 1.0 with ea\$</p>	<p>Select the checkbox to prefix any Enterprise Architect Tagged Values within any XMI 1.0 you create, with ea\$.</p>
<p>Update Last Save Time</p>	<p>Select the checkbox to update the timestamp of the last time each controlled Package was saved.</p>
<p>Report Cross Package Reference Deletions (XMI 1.1)</p>	<p>Select the checkbox to report any Package cross-references that would be deleted when a Controlled Package from an 'incomplete' model is exported to XMI 1.1.</p>
<p>Default XML Directory</p>	<p>Type in the location of the default XML directory to use when importing and exporting XML, or click on the <input type="button" value="..."/> button and browse for the location.</p>
<p>Close</p>	<p>Click on this button to save the changes you have made, and to close the 'Preferences' dialog.</p>

Customize the Desktop

As you work on your project, creating and reviewing model structures, you can make use of a wide range of system windows that help you locate and focus on particular types of object or object property. To make your modeling tasks even easier, you can fix these windows in a convenient place on your screen, move them around, set them as callable tabs or auto hide them.

Using Workspace Layouts, accessible from the Ribbon bar or from the Portals, you can also quickly load different sets of windows that target particular tasks. You can also save your favorite layouts and recall them when required.

You can access these windows through ribbon options or through keyboard key combinations. However, the fastest way to select and open any window in Enterprise Architect is to use the Quick Access panels, as described in the *Window Quick Access* Help topic.

One of the strengths of Enterprise Architect is that you can work in a central view and instantly view and edit aspects of your model in one or more of the windows surrounding the central view. Having completed your review in a window, however, you can quickly switch focus back to the object you were working on in the central (or 'active') view by pressing Ctrl+Shift+` (effectively Ctrl+~).

Which are the Standard windows?

Window	Description
Browser	The Browser window is the primary mechanism for navigating through and exploring your model and is the starting point for many of the most important features in Enterprise Architect. It lists the model Packages, diagrams, elements and element features in a hierarchical structure, reflecting the arrangement of Packages and elements within your model.
Element Browser	The Element Browser is the 'Details' tab of the Inspector window. This is one of the most useful and important information displays in Enterprise Architect. You can use the 'Details' tab to summarize, review and manage a wide range of properties and features of the selected element, such as relationships, operations, attributes, requirements and maintenance items.
Properties	The Properties window provides an immediate method of viewing and editing the properties of a selected object - element, diagram, connector, attribute, operation, Maintenance Item, Project Item, test or associated file.
Notes	Notes are the main documentation feature you use to describe an element, diagram, feature or connector; in the documentation that Enterprise Architect generates, notes feature prominently. You can record and view notes on a modeling object using the Notes window.
Responsibilities	The Responsibility window is a tabbed window through which you can quickly add, view, edit and delete rules applied to the selected element. The entities that impose such rules are requirements, scenarios, and constraints applied to the element, and external files containing information relevant to the element.
Traceability	Using the Traceability window you can quickly see what elements are immediately linked to the selected element and in what relationships, and what elements are indirectly linked via a chain of relationships. You can also select a diagram and explore the relationships of all elements in that diagram.
Relationships	The Relationships window lists all the relationships of the currently-selected

	element, and shows the properties of each relationship.
Library Window	The Library window provides a structured internal forum that your team can use to discuss aspects of the model content and development.
Diagram Toolbox	The Diagram Toolbox is a panel of icons that you drag onto a diagram to create elements and connectors. Related elements and connectors are organized into Toolbox pages, each page containing the elements or connectors used for a particular type of diagram.
Diagram Filters	You use the Filters & Layers window to modify the display of diagram components so that relevant items are immediately identified for the reader's attention, without damaging the structure and integrity of the model.
Layout Diagrams	The Layout Diagrams window provides a set of diagram layout formats that you can apply to a diagram you have created, to automatically reorganize the layout to make it more readable.
Pan and Zoom	The Pan and Zoom window enlarges the current diagram by a percentage you define, and displays a thumbnail view of it with a shaded rectangle. As you move the shaded rectangle with the mouse, the diagram shows the magnified items of the structure underneath the rectangle.
Resources	The 'Resources' tab of the Browser window provides useful shortcuts and re-use functions for creating and applying stock components in the current model. The tab contains a tree structure of document templates, Relationship Matrix profiles, stylesheets, patterns and commonly-used model elements. The tab can also provide access to UML Profiles and MDG Technologies, although this is not the recommended route to these facilities.
Source Code Viewer	The Source Code Viewer window displays the generated source code for a selected Class element, and provides a number of facilities for editing that source code.
Scripting	The Scripting window hosts a flexible and easy to use scripting capability to create scripts in JavaScript, Microsoft JScript or VBScript. Using a built in 'Repository' object, you can programmatically inspect and/or modify elements within the currently open model. The window provides tools to edit, run, debug and manage your scripts.
Debug	The Debug window provides a set of facilities for starting, managing and halting a debug session on the code generated from elements of your model.
Maintenance	The Maintenance window, or workspace, lists the maintenance records (features, changes, documents, issues, defects and tasks) for a selected element, ready for modification or addition. The window provides several facilities for managing the maintenance records.
Project	The Project Tools window provides facilities to record and manage the events, decisions, effort, risk and metrics associated with the work in developing the area of the model represented by the selected element.
Testing	The Test Cases window, or workspace, lists the test records for a selected element, ready for modification or addition. The window provides several facilities for managing the test records.
	The Learning Center provides quick access to a range of context-specific task

Learning Center	guides in a number of work areas of the system, such as Getting Started, Modeling or Testing.
-----------------	---

Notes

- On the Testing, Maintenance and Project Tools windows, any descriptive text, history, input or results for a selected item are also displayed in the Notes window

Visual Styles

It is possible to change the overall style and color of the Enterprise Architect user interface to match the standard styles (or themes) of a number of Microsoft Office and Visual Studio product releases. The styles are applied uniformly across all displays, dialogs, windows, views and ribbons.

To test the style that you are selecting, simply click on the Apply button.

This image illustrates the 'Microsoft Office 2016'® style, using different themes and accent colors.

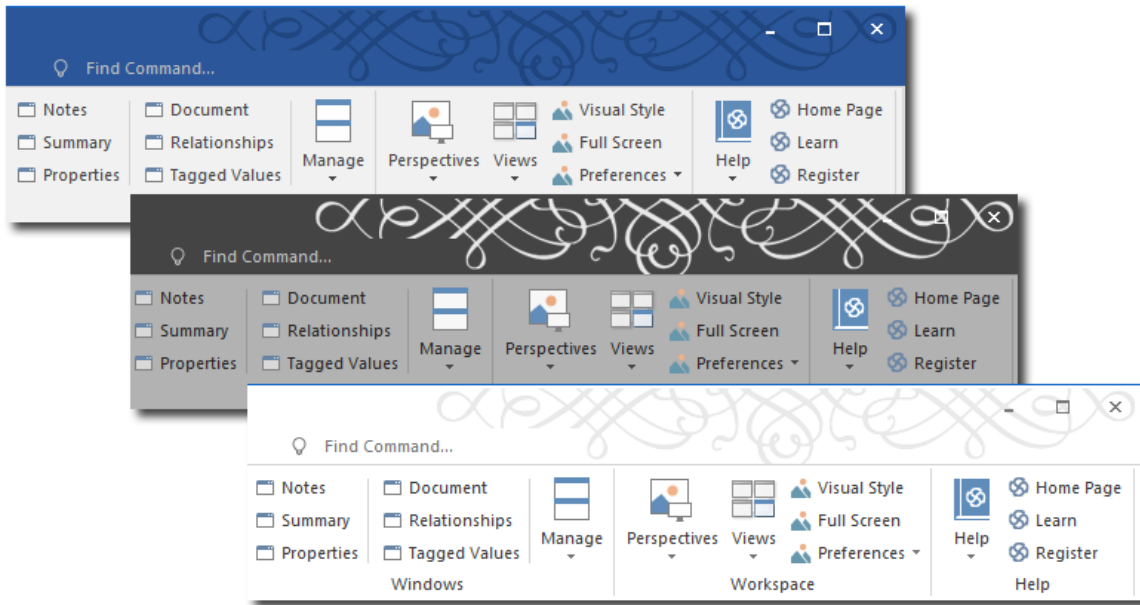

Access

Ribbon	Start > Appearance > Visual Style
--------	-----------------------------------

Reset the style of the user interface

Define the visual style you want to use, on the 'Application Look' dialog.

Option	Action
(top field)	Click on the drop-down arrow and select the application style you want to apply.
Theme	For certain application styles, you can also apply a color theme. If this field is enabled, click on the drop-down arrow and select the required theme color or tone.
Accent Color	For certain application styles, you can also change the accent color for messages and highlights. If this field is enabled, click on the drop-down arrow and select the required accent color.

Code Editor	<p>Click on the drop-down arrow and select an option to apply, within the code editor views:</p> <ul style="list-style-type: none"> • The automatic default background color of the code panel for the application style • A dark background for the code panel, or • A light background for the code panel <p>You can also re-set the dark and light backgrounds on the 'Editor Language Properties' dialog.</p>
Diagram	<p>Defaults to the diagram theme currently set in the 'Preferences' dialog.</p> <p>If you want to apply a different diagram theme, click on the drop-down arrow and select the required theme.</p>
Workspace Orientation	<p>Many of the workspace layouts have a left orientation or a right orientation, most easily observable in the side of the screen that the Browser window displays on.</p> <p>You can use this 'Workspace Orientation' field to specify the orientation you prefer - click on the drop-down arrow and select either 'Left' or 'Right' to automatically position the Browser window and related displays in your preferred workspace on the corresponding side of the screen.</p>
Default Note Zoom	<p>Click on the drop-down arrow and select the percentage zoom or magnification (from 90% up to 150%) to apply to the text in the element Notes window and any text field that has the Notes toolbar at the top. The field defaults to 110%.</p>
Note Editor Font	<p>If the text in the Notes window, 'Notes' fields and 'Description' fields does not render as well as you would like, you can change the font used. Click on the drop-down arrow and click on an appropriate font.</p> <p>To apply the change, restart Enterprise Architect.</p> <p>If you decide to revert to the default font, click on the Clear button and again restart Enterprise Architect.</p>
Internal Tab style (restart)	<p>Click on the drop-down arrow and select the required style to apply to the internal tabs of docked windows. The option does not affect the internal tabs of views or dialogs, nor does it change the tabs of the Browser window or Database Builder.</p> <p>The different types of style make the tabs display with - for example - rounded or squared-off corners, with a 2D or 3D effect, overlapping or with a common border, or with a colored underline.</p> <p>Docked windows that contain a shared horizontal scroll bar (such as the System Output window or Find in Files window) will only change to the Pointer style, where the tabs have no outline but do have an arrow shape in the line underneath the tab. Otherwise they keep the Flat style (flattened pyramid shape).</p> <p>When you have made your selection, you must re-start Enterprise Architect to bring this style into effect.</p>
Show Menu Icons	<p>Select this checkbox to display icons next to the menu options (where they have been assigned).</p> <p>Deselect the checkbox to hide the icons and show simple lists of text options.</p>
Main View Tabs use Caption style	<p>Select this checkbox to display the icons and names of the main view tabs in a larger format.</p>
Main View Tabs at bottom	<p>When a main view has tabs, by default the tab names display at the top of the view.</p>

(restart)	<p>If you prefer to display the tab names along the bottom of the view, select this checkbox.</p> <p>The change does not take effect until you shut down and restart Enterprise Architect.</p>
Property Sheets use Tree style	<p>By default 'Properties' dialogs and various other screens present sections of data on tabs.</p> <p>If you prefer to display the sections of data on dialog pages, where you choose the pages from a tree or hierarchy on the left of the dialog, select this checkbox.</p>
Use Property List for Elements	<p>By default element 'Properties' dialogs show the main properties as a series of fields on the right of the dialog.</p> <p>If you prefer to display the properties as a simple list of names and editable values, select this checkbox.</p>
Increase Note Paragraph Spacing	<p>Increases the paragraph spacing from the default, in all new text in the element Notes window and all text fields with the Notes toolbar at the top. The change is applied to all paragraph styles, including bullet and number lists.</p> <p>The paragraph spacing is increased in existing text when you open and close a dialog containing that text.</p> <p>When you deselect the option, all new Notes text reverts to the default spacing.</p>
Enable Concise Diagram Navigation	<p>Enable diagram navigation elements such as a Nav Cell, Diagram Hyperlink, Package with a child diagram and others to open a diagram (and replace the current diagram) in the active tab. You can move back through previously opened diagrams using the Backspace key or by clicking the back arrow on the right of the diagram tab. The same behavior is available when a diagram is floated.</p> <p>When this option is enabled, you can also click on a Composite element and press the = key to open the Composite diagram in the same tab. In this case, if you press the Backspace key to return to the parent diagram, the Composite element remains selected.</p>
OK	Click on this button to save and apply the changes, and close the dialog.
Cancel	Click on this button to cancel the changes and close the dialog.
Apply	<p>Click on this button to apply the changes but keep the dialog open for further editing.</p> <p>If a change takes immediate effect, you can see it on any open windows and then, if you prefer something different, change the setting.</p> <p>If you click on the Apply button and the Cancel button, the changes still take effect.</p>

Docked Windows

When you are doing work using one or more of the Enterprise Architect windows, you can re-position and/or group the windows to make them easier to use. You can easily move any window around the application workspace and either dock (anchor) it against the top, bottom, left or right edge of the workspace for long-term use, or just drop it where it is most convenient for the moment (that is, leave it floating).

All the windows are resizable, so you can also drag the window margins to make the window a convenient size and shape to display either just a column or row, or a large section of the information it contains.

Dock a Window Against an Edge

Notice that the window docking is an insert, not an overlay; in the illustration (step 3), the left border of the Start Page is **moved** to sit just under the 'ticked man' icon in the toolbar.

The docking behavior varies depending on whether you have already docked other windows on the screen, whether you use the navigation compass or the compass point icons, and where you drag the docked window before you release the mouse button. If you drag and release the window over:

- A point of the navigation compass in the center of the screen, the window sits inside existing docked windows (for example, in the illustration a window released on the bottom, top or left icons of the navigation compass would be docked to the **right** of the Traceability window)
- A separate compass point icon on the edge of the screen, the window is docked on the outside edge of the screen and existing docked windows are pushed inwards
- A point of the navigation compass at the edge of the screen (only when there is already a docked window there) the window is docked within the area occupied by the previously docked window (for example, in the illustration you could dock your new window as the left, right, top or bottom segment of the Traceability window space; the Traceability window itself is reduced in size to accommodate the new docked window, but you can then adjust the margins of the two docked windows to improve readability)
- The center of the navigation compass at the edge of the screen (only when there is already a docked window there) the window is docked as a tab of a window frame; see *Dock Windows into a Frame*

The highlighted area always indicates exactly where the moved window will be docked, so you have an indication of the effect before you release the window.

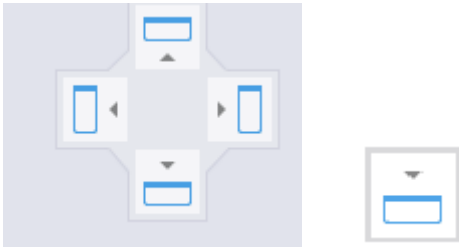
Step	Action
1	<p>Click on the title bar of the window and start to drag it towards the appropriate edge of the workspace. A set of positioning icons display, consisting of a navigation compass in the body of the application workspace and a compass pointer in the middle of each edge.</p> 
2	<p>Drag the window onto a compass point.</p> <p>The screen display shades the area that the window will fill, once you release the mouse button. Notice in this screen capture that the left-hand quarter of the compass has thickened borders, indicating that the window has been dragged over it.</p>

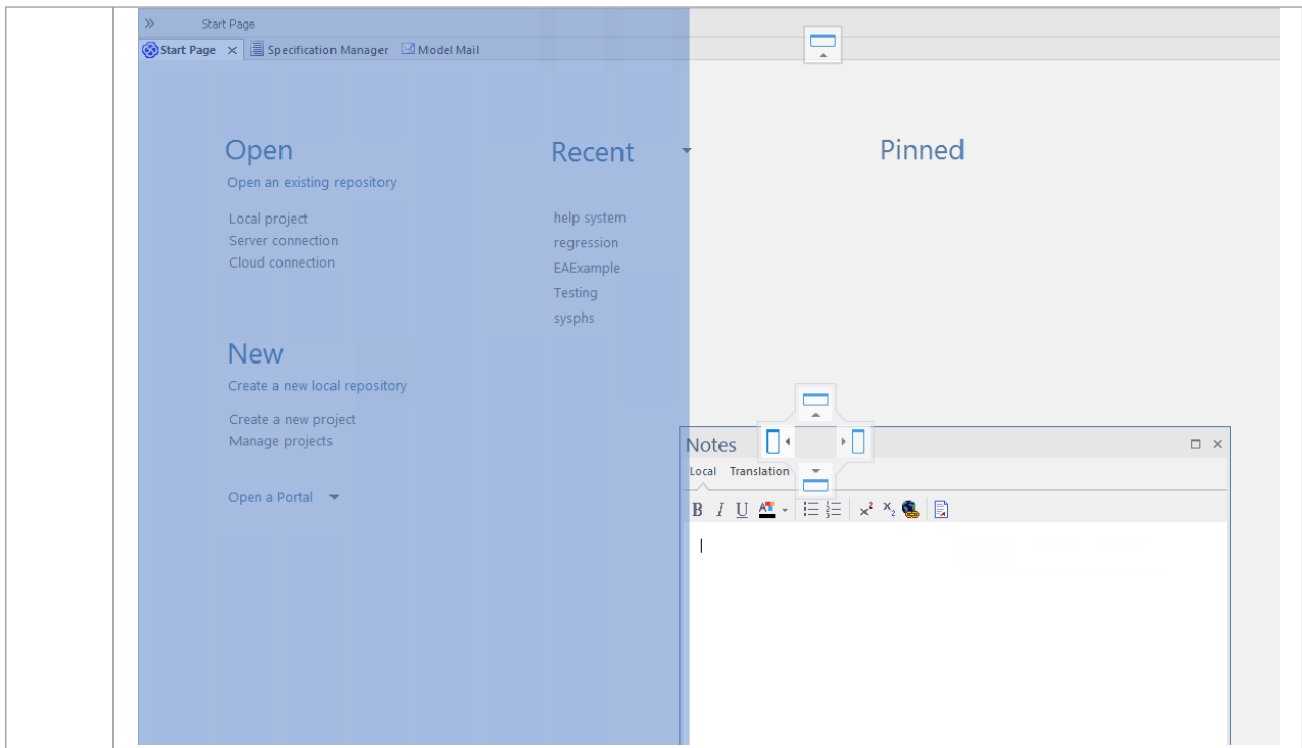

3 Release the mouse button to dock the window.

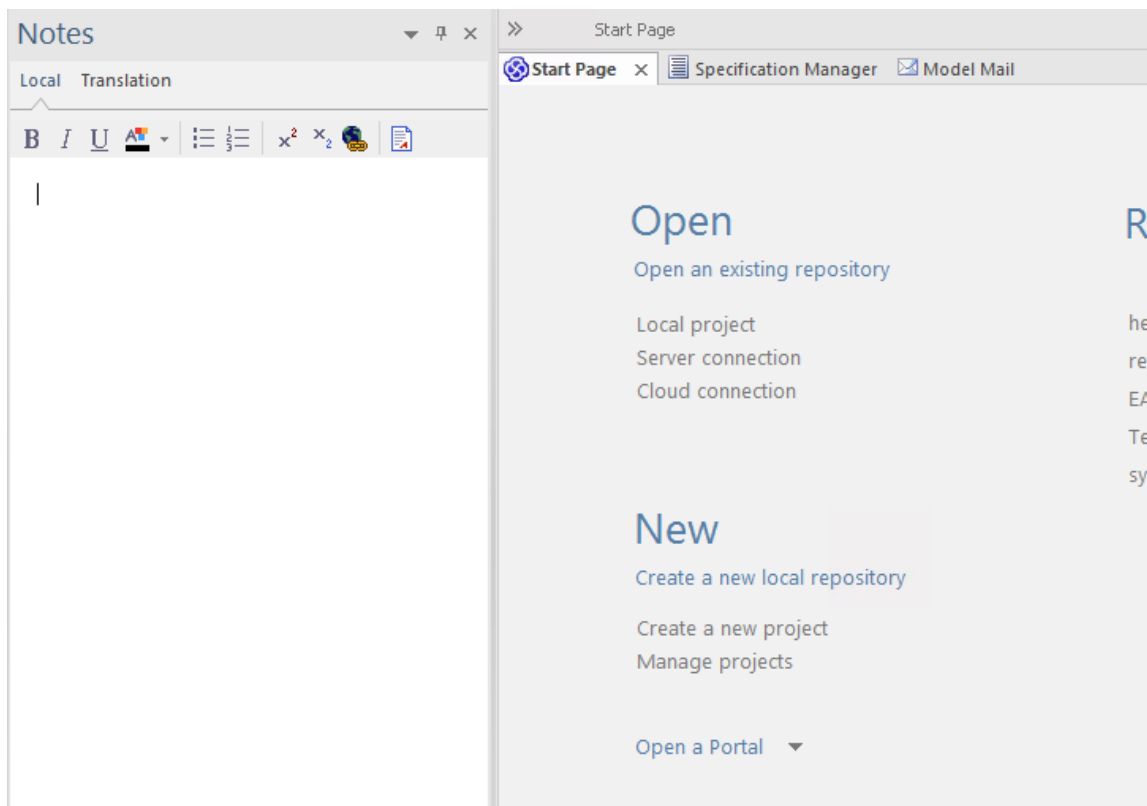

The docked window initially fills the previously-highlighted space, but you can drag the margins to resize the window, if required.

Dock Windows into a Frame

A docked window does not overlap any other window, so if you are docking several windows you progressively fill up the workspace; however, you can avoid this by combining the docked windows in a single tabbed frame by either:

- Dragging the title bar of each window up to the title bar of the first docked window, or
- Dragging each window over the 'tabbed frame' icon in the middle of the navigation compass, when the compass is over the previously-docked window that you want to combine the dragged window with; when you release the mouse button, the window becomes a tab of the frame

Initially, the window you are moving is visible with the tabbing compass.

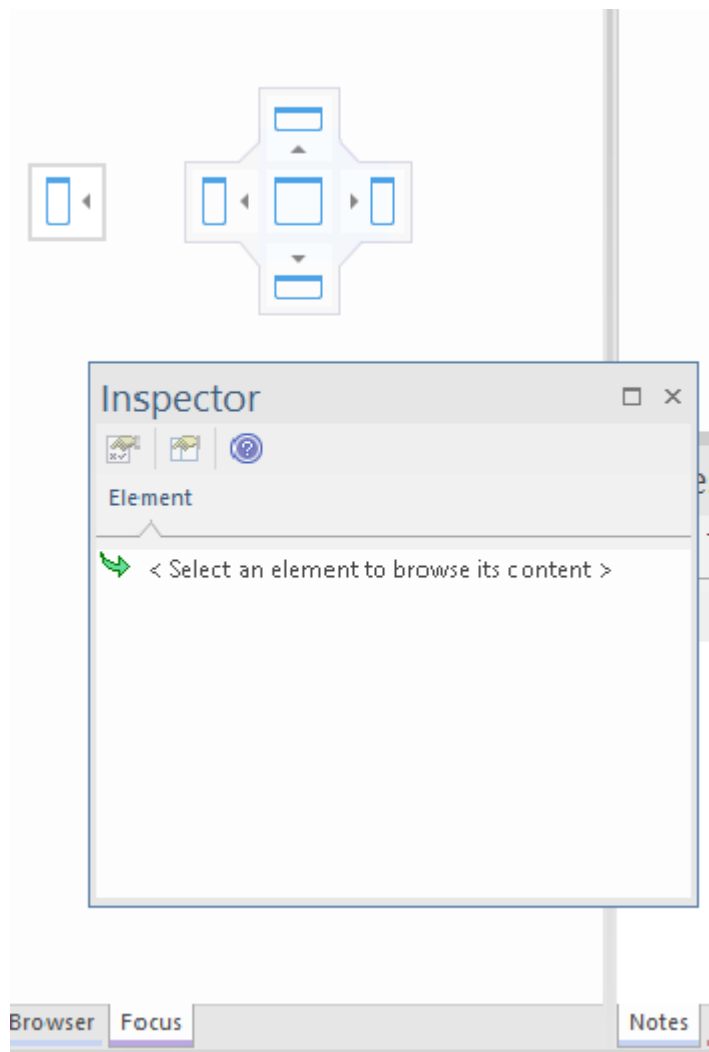

Notice that the center of the compass has a square inside it, and the tabbed frame shows the names of the windows it currently contains. As you move the new window over the square in the center of the compass, it disappears but its name is added as a tab of the frame.

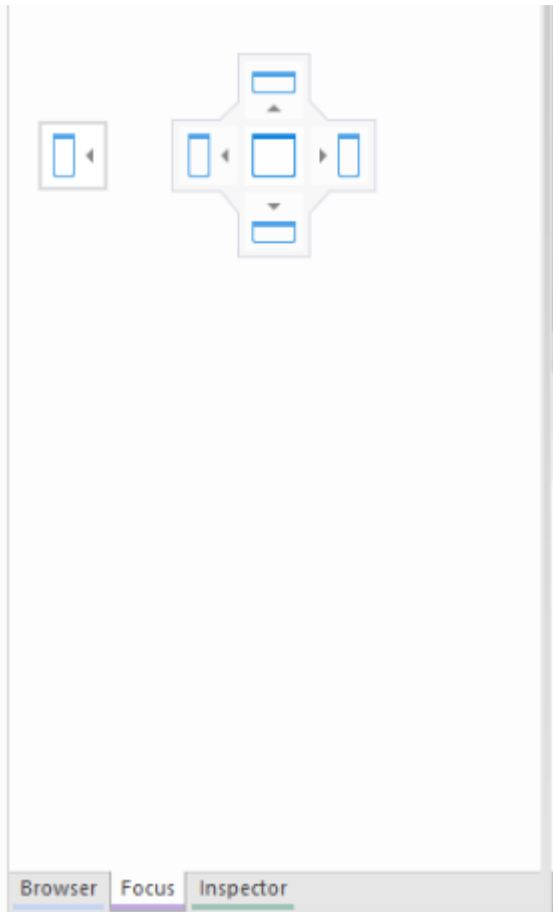

When you release the mouse button to finish dragging the window into place, the compass disappears and the window displays as a tab of the frame.

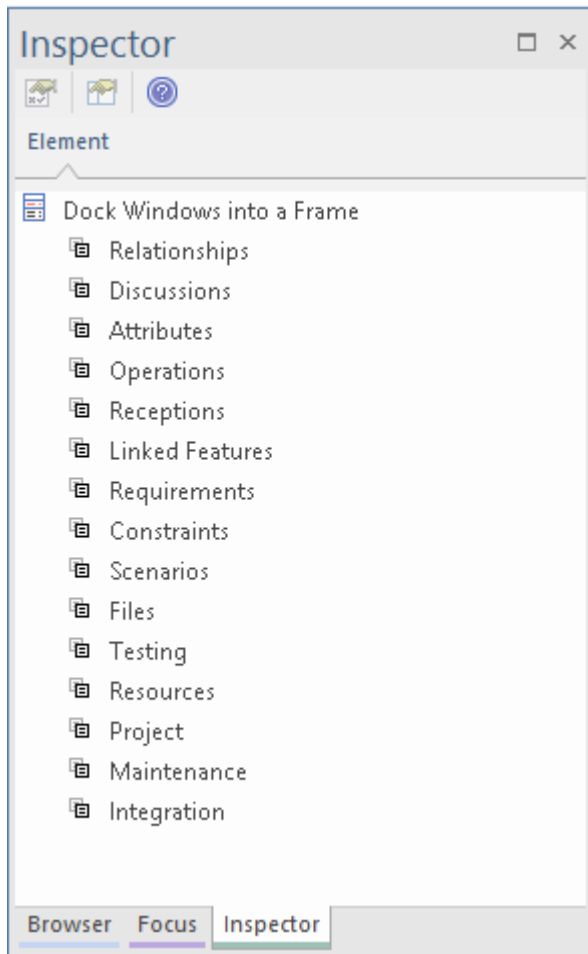

You can move and re-dock the frame of windows as if they were a single window.

To separate a window from a tabbed frame, click on the window's tab at the bottom of the frame and drag it away.

Close Docked Windows

If you do not want to have a docked window open any longer, click on the window header and press **Ctrl+F4**. This just closes the selected window; if the window is in a tabbed frame, the other windows in the frame remain open.

Floating Windows

To float a window anywhere on the screen, click on its title bar and drag it to where you want it to sit. The navigation compass displays, but you ignore it in this situation. Floating windows can overlay each other, which is convenient if you want to compare information displayed in two windows. You can drag one window under or over another so that the relevant pieces of information are adjacent, do your check, then move the windows apart again.

Auto Hide Windows

If you are using docked windows, you can have them available for use but kept minimized or hidden until you actually need to use them. The windows are represented by tabs in the top, bottom, left or right margins of the work area. In the illustration, the Browser window is the open hidden window with the Focus window, Inspector window, Properties window, Discuss & Review window and Diagram Toolbox hidden in the margin.

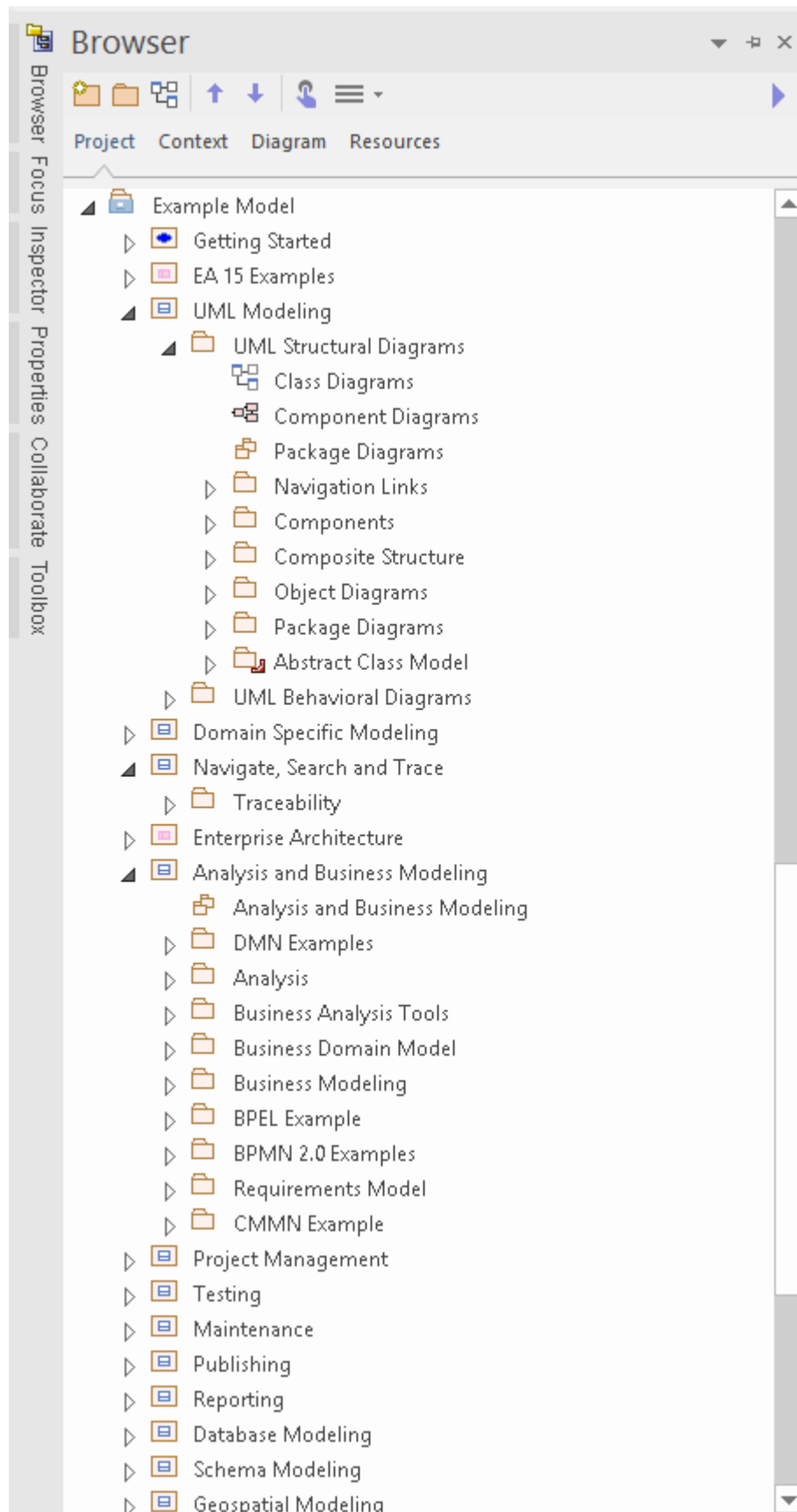



When you move the cursor over the tab, the window overlays the screen and you can work within it. As soon as you move the cursor out of the window, it automatically contracts into the margin tab again. This means that you have the maximum work area for performing your main task, with the convenience of still being able to immediately use any of a wide range of other windows.

If you 'hide' a tabbed frame of docked windows, those windows are hidden together in one click. Each window behaves in the same way as before, but if you cancel auto hide on one of them they are all released.

When you cancel the auto hide on a docked window (or a frame of windows) it will persist on the screen as an insert (pushing visible window borders across to take up some of the display) when you select it.

Auto Hide a Window or Set of Windows

- To set the displayed window to 'auto hide', click on the  button in the top right corner of the window; any other windows in the same frame as the open window are set to 'auto hide' as well
- To turn off 'auto hide' for a particular window, or set of windows within a frame, click on the  button

Notes

- You can only auto hide docked windows; if you want to auto hide a floating window, dock it against a margin first
- When you select an auto hidden window, it immediately displays against the nearest work area margin; you can make the auto hidden window slide out of and into the margin by selecting the 'Animate Autohide Windows' checkbox on the 'Window Behavior' page of the 'Preferences' dialog ('Start > Appearance > Preferences > Preferences > General > Window Behavior')

Advanced Customization

Enterprise Architect has a standard style and appearance, which you can customize to suit your own work environment. Several facilities are available for customizing:

- The means of issuing commands to the system - such as ribbons, toolbars and keyboard keys - and the commands themselves
- The visual style and color of the user interface
- The windows you want to display together on the screen, and their position on the screen (the 'Workspace Layout')

On occasion, you might want to use Enterprise Architect for two distinct types of operation at the same time. You can do this by storing registry settings - such as window layouts - to a different path in the registry, by adding this command line argument when you run Enterprise Architect:

```
/regkey:<regkeyname>
```

You can also configure a wide range of local options and specific settings for using Enterprise Architect on your workstation, through the 'Preferences' dialog. These options apply to all models that you work in using Enterprise Architect on your workstation.

Customize Dialog

It is possible to customize the Enterprise Architect toolbar and keyboard commands and how they are displayed and made available to you, tailoring the user interface to suit your work methods and environment. You can also define a number of external applications that you can activate from the 'Tools' menu. You perform these tasks using the 'Customize' dialog.

Access

Ribbon	Start > Application > Preferences > Other Options
Other	At the far right of any toolbar, click on the drop-down arrow and on the 'Add or Remove buttons Customize' option

Notes

- If a documented toolbar icon, keyboard combination or menu facility does not appear to be available, select the appropriate tab and click on the Reset button or Reset All button to restore the toolbar, menu or key settings to the defaults; however, this also removes any customized icons, options or combinations you might have set, because it is possible that the customization itself has displaced or affected the default setting

Customize Commands

The Enterprise Architect toolbars provide a wide range of functions, some of which are useful in several different contexts. You might find it more convenient to have a function command available either from a different toolbar to the one it is currently set in, or from more than one toolbar. You can customize which toolbar a command is available from by generating a button or icon for the command on either another existing toolbar or a new toolbar that you create for this purpose. Conversely, you might remove a command from its current toolbar, to simplify the selection of tools from that toolbar.

Access

Ribbon	Start > Application > Preferences > Other Options > Commands
--------	--

Manage Toolbar Commands

Task	Action
Add Command To Toolbar	<p>Also display the appropriate toolbar, using:</p> <ul style="list-style-type: none"> 'Explore > Portals > Show Toolbar > <toolbar name> <p>The toolbar icons are then highlighted with a dark border as you select them.</p> <p>On the 'Commands' tab:</p> <ol style="list-style-type: none"> Click on the appropriate command category in the 'Categories:' panel. Click on the command you need from the list in the 'Commands:' panel. Drag the command onto the toolbar; it is immediately placed in the toolbar at the cursor position. Add any further commands you want. Put the icons in the order you prefer, by dragging each icon into position. Click on the Close button to close the 'Customize' dialog. If necessary, resize the toolbar or drag it back into the top of the screen. <p>If the command has an associated icon, the icon displays in the toolbar; otherwise, the command name displays.</p>
Delete Command from Toolbar	<p>While the 'Customize' dialog is displayed, right-click on the command icon or text in the toolbar, and select the 'Delete' option. The command icon is immediately removed from the toolbar.</p> <p>The context menu does not display if the 'Customize' dialog is closed.</p>
Change or assign icon for command	<p>All commands listed in the 'Customize' dialog have a text label, and many have associated icons, either system-defined (default) or user-defined. If the command has an icon, you can select to represent the command in the toolbar by:</p> <ul style="list-style-type: none"> The icon The text Both together <p>You have a range of other options for changing how the command is represented in</p>

	<p>the toolbar, such as:</p> <ul style="list-style-type: none"> • If the command does not have an associated icon, assign one from an image library • Change the icon currently assigned to the command to a different icon • If the command has a system default icon and you have changed it, restore that default icon to the command • Edit the icons in the library, and create new ones; you can also copy an existing icon and edit the copy <p>These options are available through a context menu that you display by right-clicking on the icon in the toolbar while the 'Customize' dialog is displayed. The context menu does not display if the 'Customize' dialog is closed.</p> <p>The changes apply only to the selected toolbar. Any instances of the command in other toolbars or menus are not affected.</p>
Toggle command button between icon, text and both	<ol style="list-style-type: none"> 1. Right-click on the command icon or text in the toolbar. 2. Select the context menu option you need - 'Image', 'Text' or 'Image and Text'. <p>If the option has an icon, the selected change is made. If the command has no icon, the 'Button Appearance' dialog displays. You can also toggle between the image/text options on this dialog.</p>
Assign icon to command	<ol style="list-style-type: none"> 1. Right-click on the command icon or text in the toolbar. 2. Select the 'Button Appearance' option; the 'Button Appearance' dialog displays. 3. Select either the 'Image only' radio button or the 'Image and text' radio button. 4. For a command with a default icon, the 'Use Default Image' radio button is followed by the default icon; if you have assigned a different image, you can restore the default by selecting this radio button. Otherwise, select the 'Select User-defined Image' radio button, and click on an appropriate image from the selection provided. You can add or edit images in this selection. 5. Click on the OK button to apply the changes to the toolbar. <p>(You can also restore the default icon by right-clicking on the current icon in the toolbar and selecting the 'Reset to default' option.)</p>
Copy a toolbar icon	<ol style="list-style-type: none"> 1. Right-click on the icon in the toolbar. 2. Select the 'Copy Button Image' option; the image is copied to the clipboard.
Create and edit icons	<ol style="list-style-type: none"> 1. Right-click on the command graphic or text in the toolbar. 2. Select the 'Button Appearance' option; the 'Button Appearance' dialog displays. 3. Select either the 'Image only' radio button or the 'Image and text' radio button. 4. Select the 'Select User-defined Image' radio button. 5. To create a new image, click on the New button; to edit an existing user-defined image, click on the image and then on the Edit button. The 'Edit Button Image' dialog displays. 6. If you have copied another icon to edit as a new icon, click on the Paste button in the 'Tools' block. 7. Select a color and the appropriate painting tool - the 'pencil' fills individual squares, the 'filler' fills the whole 'Picture' block, and the 'line' creates lines of two or more squares thick. 8. Create or edit the icon, working right up to the border of the 'Picture' block if necessary. 9. Click on the OK button to apply the changes to the toolbar.

Change icon text label	<ol style="list-style-type: none">1. Right-click on the command graphic or text in the toolbar.2. Select the 'Button Appearance' option; the 'Button Appearance' dialog displays.3. Select either the 'Text only' radio button or the 'Image and text' radio button.4. In the 'Button text' field, highlight and delete the existing text and type in the new text.5. Click on the OK button to apply the changes to the toolbar.
Group Icons	<p>If necessary, you can indicate that the command icons are arranged in groups. To do this:</p> <ol style="list-style-type: none">1. While the 'Customize' dialog is displayed, right-click on the first command icon or text in the group in the toolbar, and select the 'Start Group' option. <p>A vertical line displays to the left of the icon. All icons to the right of the line form a group, up to any subsequent line.</p> <p>To remove the line and cancel the grouping, repeat the step.</p>

Customize Toolbars

As well as tailoring the commands that are available through the toolbars, you can modify the toolbars themselves; for example, you can:



- Hide or show toolbars by selecting the appropriate checkbox
- Rename toolbars
- Create new toolbars
- Delete toolbars
- Modify toolbar contents by dragging commands onto a visible toolbar from the 'Commands' tab or from another toolbar
- Reset a toolbar (or all toolbars) to the default contents and position, and
- Display text labels under the toolbar icons, to indicate what the icons do

Access

Ribbon	Start > Appearance > Preferences > Other Options > Toolbars : New
--------	---

Create a New Toolbar and Populate it with Commands

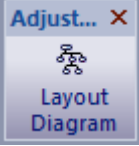
Step	Action
1	In the 'Toolbar Name' field, type a name for your new toolbar and click on the OK button. Your new toolbar is created. The toolbar and 'Customize' dialog are independently positioned, so you might have to drag the 'Customize' dialog to one side to expose your new toolbar.
2	If you want to display the name of each command you put into your toolbar, select the 'Show text labels' checkbox. Otherwise leave the checkbox unselected.
3	To add commands to your new toolbar from another toolbar, see step 6. To add menu commands to your toolbar, click on the 'Commands' tab. The 'Categories' list on the left of the tab represents the Enterprise Architect menu structure. The 'Commands' list contains the commands in the selected category; the list updates when you click on a different category.
4	Find and click on the command to add to your toolbar in the Commands list.
5	Drag the selected command from the list into the new toolbar. If you selected the 'Show text labels' checkbox, your toolbar should now resemble this:

	 <p>If you did not select the 'Show text labels' checkbox, your toolbar should resemble this:</p> 
6	<p>If the command you require is on another toolbar, display that toolbar and drag it to a position near your new toolbar.</p> <p>Press Ctrl and drag the required icon for the command from the existing toolbar onto your new toolbar.</p>
7	<p>Repeat steps 3 to 6 for each command that you want to make available in your new toolbar.</p> <p>When you have finished, click on the Close button on the 'Customize' dialog and drag your toolbar into the toolbar ribbon or to any other convenient position for you to use.</p>

Notes

- You can add as many commands to your toolbar as you need; your new toolbar behaves the same way as other toolbars - you can position it next to the other toolbars at the top of the application workspace, dock it to the side of the workspace or close it
- You can also modify the display of toolbar options using the 'Options' page of the 'Customize' dialog

Add Custom Tools

You can extend the power of the Enterprise Architect desktop by making external tools accessible from the ribbons. You can create options that hyperlink to different applications, compilers, batch scripts, automation scripts, URLs or documentation. The tools can be either commercially available or those you have configured yourself.

Access

Ribbon	Start > Appearance > Preferences > Other Options > Tools : 
--------	--

Add and configure custom tools

Option	Action
Menu contents	In the boxed, blank field in the list, type in the name of the tool as it should appear in the menu.
Command	Either: <ul style="list-style-type: none"> Type the name of the tool .exe file to use, or Click on the  button and browse to the file location The .exe file must have a valid filename.
Arguments	Type in any arguments required by the tool
Initial directory	(Optional) Type in the location of an initial directory.
Close	Click on this button to close the 'Customize' dialog. Your tool is added to the 'Tools' menu.

Open External Tools

When configuring custom tools in Enterprise Architect, by selecting 'Start > Appearance > Preferences > Other Options > Tools', you can:

- Specify the custom tool (application) using the 'Command' field
- Define a file to open using the 'Arguments' field

Example 1

This configuration opens the file `c:\Temp\Customer Account.cls` using Wordpad. If you save from within Wordpad the initial directory is `c:\Temp`.

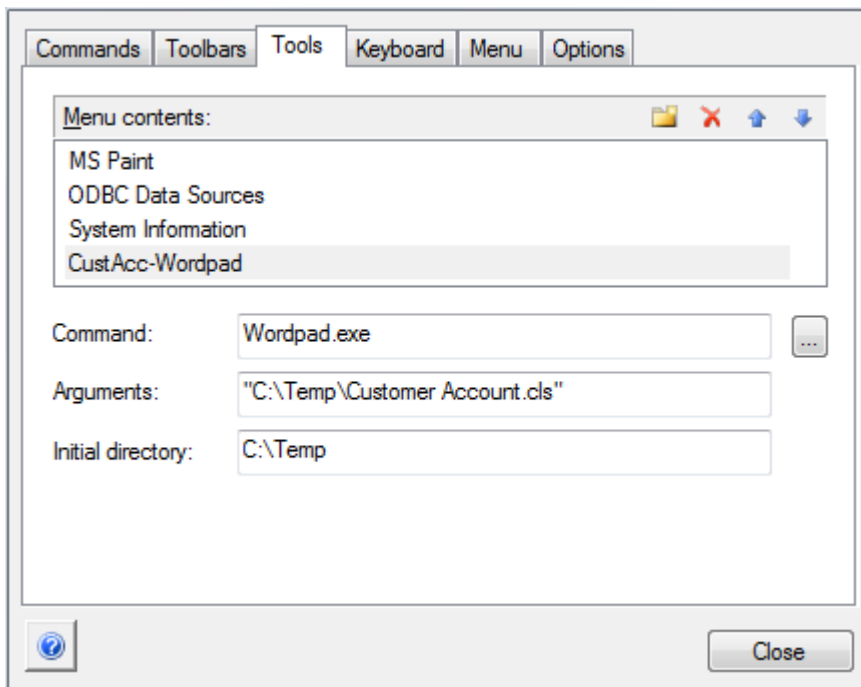

If there are any spaces in the paths in the 'Command', 'Arguments' or 'Initial directory' fields, you must enclose the whole path in double quotes. For example:

`"c:\Temp\Customer Account.cls"` must have quotes, but `c:\Temp\CustomerAccount.cls` does not have to have quotes

Example 2

This example opens the file `c:\Temp\Customer Account.cls` using Visual Basic (VB). As VB is not installed with the operating system, the whole file path for VB must be included in the 'Command' field; you can locate and select this path using the  button. Again, if you save from within VB the initial directory is `c:\Temp`.

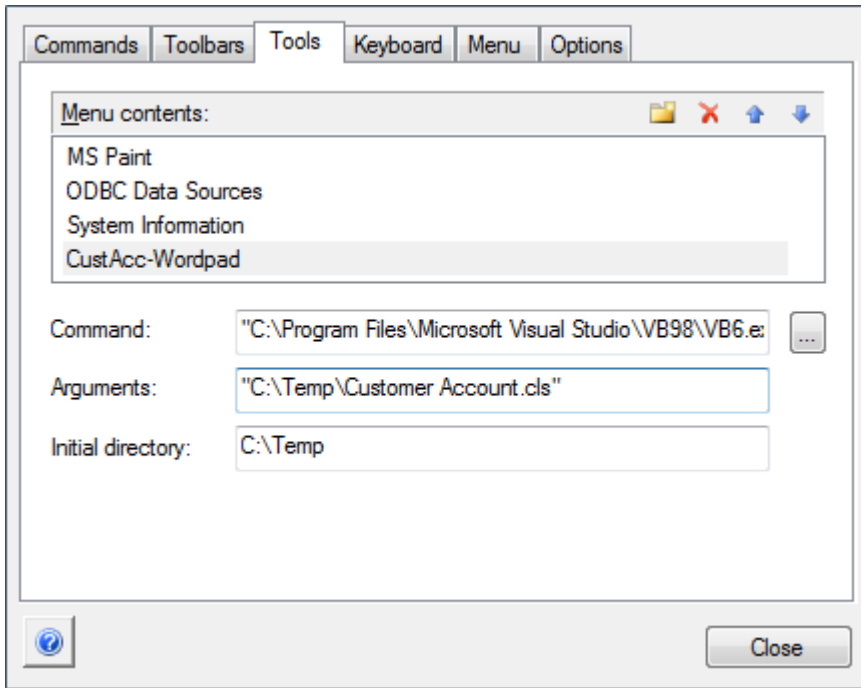

Pass Parameters to Applications

When configuring custom tools in Enterprise Architect, by selecting 'Start > Appearance > Preferences > Other Options > Tools', you can define parameters to pass to an external application using the 'Arguments' field.

Available parameters

Parameter	Passes
\$f	A project name. Notes: For example, C:\projects\EAExample.eap
\$F	The calling application. Notes: That is, Enterprise Architect.
\$p	The current Package ID. Notes: For example, 144.
\$P	The Package GUID. Notes: A GUID for accessing this Package.
\$d	The diagram ID. Notes: An ID for accessing the associated diagram.
\$D	The diagram GUID. Notes: A GUID for accessing the associated diagram.
\$e	A comma separated list of element IDs. Notes: All elements selected in the current diagram.
\$E	A comma separated list of element GUIDs. Notes: All elements selected in the current diagram.

Customize Keyboard Shortcuts

Various context menu options can also be invoked using a single keyboard key, or a combination of keys, referred to as shortcuts. You can assign your own shortcut keys to either the standard options or your customized options, to suit your work practices or other applications.

Access

Ribbon	Start > Appearance > Preferences > Other Options > Keyboard
--------	---

Create or modify a keyboard shortcut

Option	Action
Category	Click on the drop-down arrow and select the name of the context menu containing the command to assign a shortcut to.
Commands	Scroll through the list of commands and click on the one to assign the shortcut key(s) to. If the command already has a shortcut key it is shown in the 'Current Keys' field.
Press New Shortcut Key	Click on this field and press the shortcut key(s) to assign to the command. Press the actual keys to use; for example, to assign F5 press the F5 key, do not press F and then 5.
Assign	Click on this button to assign the key to the command. The button is disabled if the selected keyboard shortcut is already used for another command; if this occurs the command it is assigned to is shown in the 'Assigned to' field, and you must select a different shortcut key.
Remove	To remove a shortcut, select it in the 'Current Keys' field and click on this button. The shortcut is immediately removed.
Reset All	Click on this button to reset all commands to the default set of shortcut keys. All keys that you have assigned are removed.
Close	Click on this button to close the dialog, saving all keys that you have assigned.

Notes

- It is simpler to have one shortcut per command, although you can assign more than one shortcut if necessary
- Modified shortcut keys are stored in the registry, so they are available only to you and not to other users

Customize Submenus

It is possible to customize your submenus to add or remove shadow around the outline of each menu and to apply animation to the way in which the submenus are opened.

Access

Ribbon	Start > Appearance > Preferences > Other Options > Menu
--------	---

Animate Menu Display

Option	Description
Menu animations	<p>Click on the drop-down arrow and select one of the options:</p> <ul style="list-style-type: none"> • None - the menus are instantaneously displayed on selection • Unfold - the menus unfold from the top left corner diagonally downwards • Slide - the menus slide out from the top downwards • Fade - the menus fade in • [Default] - similar to Fade
Menu Shadows	<p>Select the checkbox to display a shadow along the right and lower edges of the menu.</p> <p>Clear the checkbox to display menus with no shadow on the borders.</p>
Close	<p>Click on this button to close the 'Customize' dialog.</p> <p>Your animation options take effect on the menus.</p>

Notes

- When you perform a major upgrade of the system (such as from release 12 to 13) the menus are reset and deleted options are replaced.

Customize Options

It is possible to customize the entire set of Toolbars to display with large icons, and/or show a Screen Tip as you mouse over each toolbar icon. The options take effect immediately, so you can see what impact they have before closing the dialog.

Access

Ribbon	Start > Application > Preferences > Other Options
--------	---

Customize Toolbar Display

Option	Description
Show Screen Tips on Toolbars	Select this checkbox to display a Screen Tip as you mouse over each toolbar icon, if a Screen Tip is defined for the icon. The screen tip is predefined in Enterprise Architect and cannot be edited.
Show shortcut keys in Screen Tips	If you have selected to show Screen Tips, select this checkbox to include any shortcut key combinations in the Screen Tip text. The shortcut keys are editable, and you can add, change or remove the keys assigned to any of the commands represented by an icon. The current shortcut key combination is added to the Screen Tip text.
Large Icons	Select this checkbox to enlarge all the Toolbox icons. This takes effect immediately, so that you can see how the display changes.
Close	Click on this button to save and commit the settings.

Workspace Layouts

As you perform work on your model you use various toolbars and windows; you will quite likely use the same toolbars and windows regularly, in an arrangement that suits the way in which you use the system. Rather than having to re-open and arrange these tools at the start of each work session, you can use either a predefined or a customized work environment or workspace.

Workspaces:

- Automatically open and organize all the tools appropriate to an area of work such as Requirements Management, Code Engineering and Debugging
- Help a new user by:
 - Opening the tools that are appropriate to a task so that they can immediately get started, and
 - Showing the user what tools they should become familiar with for that area of work
- Help you switch rapidly to work environments for either successive or completely different areas of work
- Re-establish a work environment that you have accidentally or deliberately changed

To select, create and maintain workspaces you use the 'Workspaces' page of the 'Workspace Layout' dialog, which lists the currently-available system and user-defined layouts.

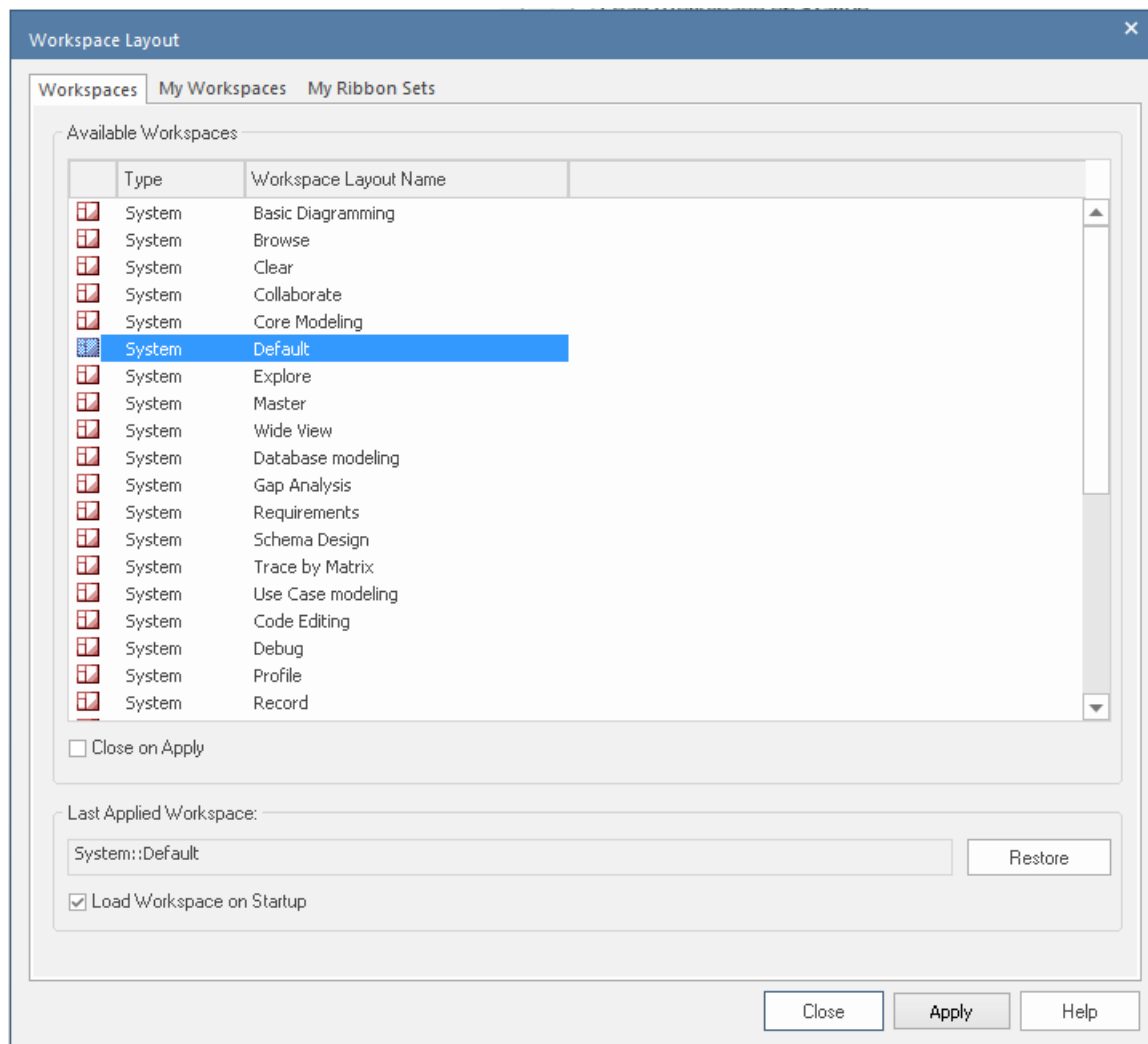

Access

Ribbon	Start > All Windows > Workspace > Workspace Tools > Workspaces
--------	--

Manage Layouts

Task	Description
Change workspace layout	<p>The 'Last Applied Workspace' field at the bottom of the 'Workspace Layout' dialog identifies the layout last selected, before any changes you might have made.</p> <p>You can change the layout to:</p> <ul style="list-style-type: none"> • The original layout (as identified by the 'Last Applied Workspace' field), discarding any changes you might have made, by clicking on the Restore button; alternatively select the 'Load workspace on startup' checkbox to restore the original workspace when Enterprise Architect is next started • One of the other named layouts, or • A new named, customized layout, capturing the current screen layout and including any changes you have made to the previously-applied layout <p>To change the layout in use, either:</p> <ul style="list-style-type: none"> • Click on the preferred layout name and on the Apply button, or • Double-click on the required layout name, or • Right-click on the layout name and select the 'Apply' option <p>If you want to experiment with layouts, clear the 'Close on Apply' checkbox. This allows you to see what effect changing the workspace has, but keep the 'Workspace Layout' dialog open so that you can try another workspace or restore the original one. When you have chosen the required workspace, reselect the checkbox so that the 'Workspace Layout' dialog closes when you click on the Apply button.</p>
Copy workspace layout	<p>Right-click on the layout name and select the 'Copy As New' option</p> <p>The 'Save Custom Workspace Layout' dialog displays.</p> <p>In the 'Custom Workspace Layout' field, type a name for the layout. By selecting an existing name you can change an existing layout to something different. Click on the Save button.</p> <p>If you already have tailored windows or views open that you want to include in your selected layout, select the 'Include active custom views' checkbox.</p>
Delete workspace layout	<p>Right-click on the (custom) layout name and select the 'Delete' option. A prompt displays for you to confirm or cancel the deletion.</p>

Notes

- If you apply a working set that invokes floating diagrams or views, it will override the current workspace layout with the layout that was in use when the working set was defined
- If you develop a workspace layout that would be useful for your colleagues, you can share it with them by incorporating it in an MDG Technology that they can download

The Browser Window

The Browser window displays your model objects and features in a number of arrangements, reflecting the content and structure of your model. The Browser window is the primary mechanism for browsing and exploring your model and is the jumping off point for many of the most important features in Enterprise Architect. You can use it to navigate through the Enterprise Architect project space and:

- Review the structure, content and organization of your model
- Drill down to and into specific elements
- Drag and drop elements and Packages within the model
- Copy (duplicate) whole Packages
- Import/export model information
- Set up Version Control, locking, execution analysis and many other aspects of the model tied to a particular Package
- Document models
- Import code, xmi and csv files, database schema and other external data sources

The Browser window provides a range of context menus through which you can perform additional actions such as adding new Packages, creating diagrams, renaming items and deleting model elements.

The full model structure is represented in the 'Project' tab of the Browser window, which is the default display.

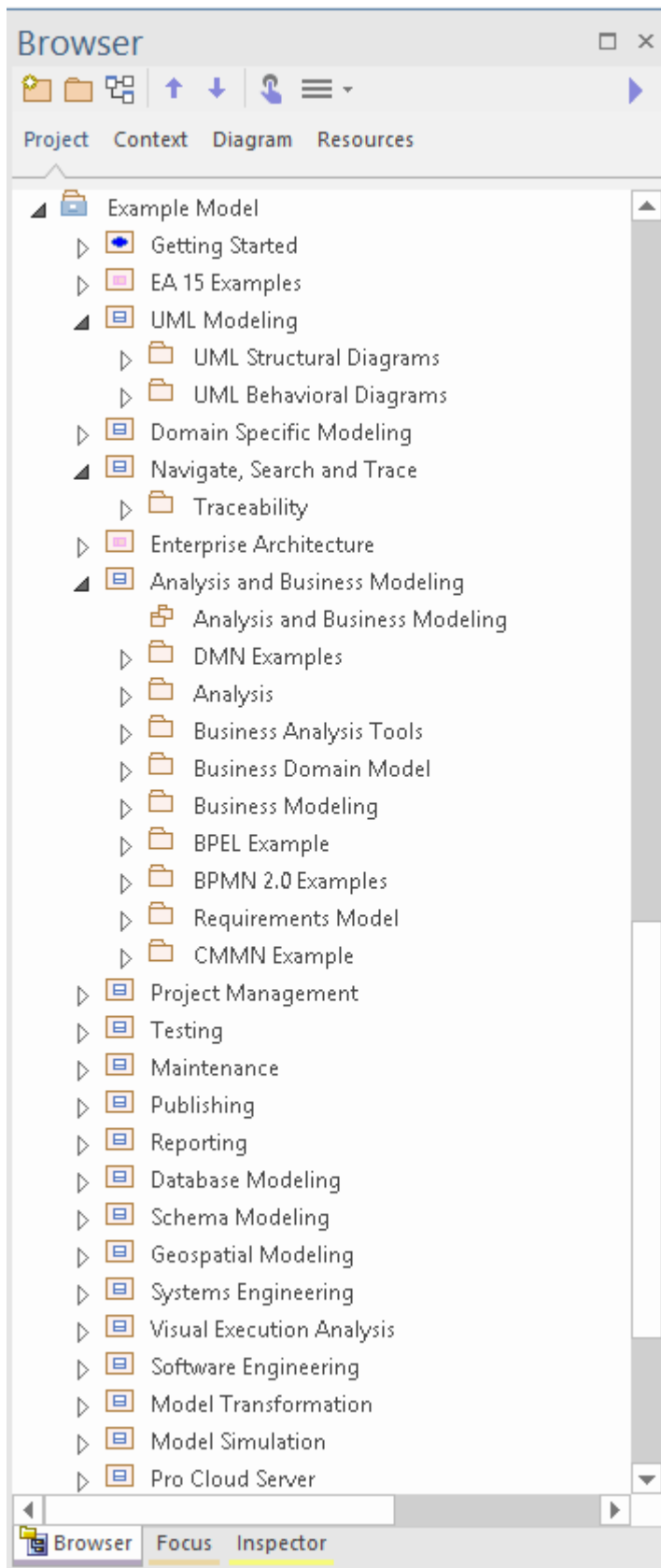

You can also select a View, Package, diagram or element at any level and focus the display on just the portion of the structure underneath that object, in these tabs:

- Context (see the *Browser - Context* Help topic)
- Diagram (see the *Browser - Diagram* Help topic)

The 'Resources' tab enables you to select and apply structures from a repository of project-standard and re-usable document generation templates, MDG Technologies, Relationship Matrix profiles, commonly-used model elements, stylesheets, UML Profiles and Patterns. See the *Browser - Resources* Help topic.

If it is inconvenient to have all Browser window tabs shown in the window, you can temporarily hide and re-display one or more of the tabs. See the *Hide and Show Browser Tabs* Help topic.

On the 'Project' and 'Context' tabs, you can also add 'Favorite' folders to present just your selection of Packages to work on. See the *Refine Browser Content* Help topic.

Access

Ribbon	Start > All Windows > Design > Explore > Browse Explore > Portals > Windows > Explore > Project Browser
Keyboard Shortcuts	Ctrl+1 Alt+1 Browser

Views

The 'Project' tab of the Browser window can be divided into Views, each of which contains diagrams, Packages and other elements. A default View hierarchy is described here, but you can create different Views to suit your requirements.

View	Description
Use Case View	The functional and early analysis View, containing Business Process and Use Case models.
Dynamic View	The dynamics of your system, containing State Charts, Activity and Interaction diagrams.
Logical View	The Class Model and Domain Model View.
Component View	A View for your system components. The high level view of what software is to be built (such as executables, DLLs and components).
Deployment View	The physical model; what hardware is to be deployed and what software is to run on it.
Custom View	A work area for other Views, such as formal requirements, recycle bin, interview notes and non-functional requirements.

Selective Collapse to the Parent Element or Package

When you are working on an expanded project in the 'Project' tab (or a large segment in the 'Context' tab) you might want to locate the parent element or Package of an item, and/or collapse the structure under that parent element or Package.

Step	Action
1	Position the cursor on an item within the element or Package.
2	Press the left-arrow key on the keyboard to highlight the parent.
3	Press the same key again to collapse the structure under that parent element or Package. If you keep repeating this sequence, you locate and collapse the parent nodes further and further up the hierarchy to, ultimately, the root node.

Adding Elements from the Diagram Toolbox

When you have a structure in the Browser window, you can add elements to it by picking them up from the Diagram Toolbox and dropping them onto the parent element or Package. To do this, you:

- Click on the element icon in the Diagram Toolbox, then click on the parent Package or element in the Browser window to select it, and click again to drop the element under the parent

You cannot add objects that must display in a diagram such as Note elements, Text elements, connectors or Boundaries.

If an element is of a type that cannot be added as a child of the object in the Browser window, an error message displays.

Changing Names

If you decide to change the name of a Package, diagram or element on the 'Project' tab, you can simply click on it and press F2. This makes the name editable, and you can quickly overwrite it.

Mouse-click Actions

There are various methods of performing actions on the contents of the Browser window, through Toolbar options, context menu options and pressing keyboard keys. These are discussed in the topics and tables describing those actions. This table identifies the results of simply clicking the mouse buttons on an object, and the variation in results caused by pressing Ctrl as you click.

Mouse Action	Effect
Single-click, Left button	<p>If you:</p> <ul style="list-style-type: none"> • Single-click the mouse button on the expansion arrow to the left of an object, it expands or collapses the structure of that object • Single click the mouse button on the object name, it highlights that object and makes it the focus of all relevant windows that are currently open (such as the Properties window and the Specification Manager); for a diagram, this means the diagram opens <p>Note that diagrammatic elements, such as Notes and Text, become the focus in several property displays but not in the Specification Manager</p>
Single-click, Right button	<p>If you right-click on an object, the object becomes the focus of all relevant windows that are open, and the appropriate context menu displays for the object type.</p>

Double-click, Left button	<p>If you:</p> <ul style="list-style-type: none">• Double-click on an object, the object becomes the focus of all relevant windows that are currently open, and the appropriate context menu displays for the object type; if the object has child objects, the hierarchy is expanded to show them• Press Ctrl and double-click on an object, the object becomes the focus of all relevant windows that are open, and the 'Properties' dialog displays for that object
Double-click, Right button	<p>If you double-click the right mouse button on an object, the object becomes the focus of all relevant windows that are currently open, and the appropriate context menu displays for the object type</p>

Browser - Header Bar

The Browser header bar provides access to several operations you can perform on your project structure and content, including opening the project in the first place. You can use the options in the header bar to create a new model through the Model Builder, add Packages and diagrams to an existing model, and move objects up and down within their object groups and parent structures. These and additional options are also available through the menu displayed by the 'Hamburger' icon.



When you first open Enterprise Architect, all the icons except for the 'Hamburger' are grayed out. You can either select a model from the 'Recent' list on the Start page, or you can click on the 'Hamburger' icon and select the 'Open Project' option. This option displays the 'Manage Projects' dialog, through which you can locate and open the required project.

Access

Ribbon	Start > All Windows > Design > Explore > Browse Explore > Portals > Windows > Explore > Project Browser
Keyboard Shortcuts	Ctrl+1 Alt+1 Browser

Icon Options

These options operate on the 'Project' and 'Context' tabs of the Browser window. In the 'Hamburger' menu options, the 'New Element' option can also update the 'Diagram' tab.

Option	Action
New Model from Pattern	Click on this icon to create a new model base structure in the project, underneath a selected Root Node. Shortcut: Ctrl+Shift+M
New Package	Click on this icon to create a new child Package under the selected Package.
New Diagram	Click on this icon to create a new child diagram under the selected Package or element.
Move Object Up	Click on this icon to move the selected object further up the Browser window list, within its parent Package and object group type (that is, within the list of elements or list of diagrams, for example).
Move Object Down	Click on this icon to move the selected object further down the Browser window, within its parent Package and object group type (that is, within the list of elements or list of diagrams, for example).
Find in Browser	For an object selected in a dialog, diagram or window, locates that object in the Browser window.

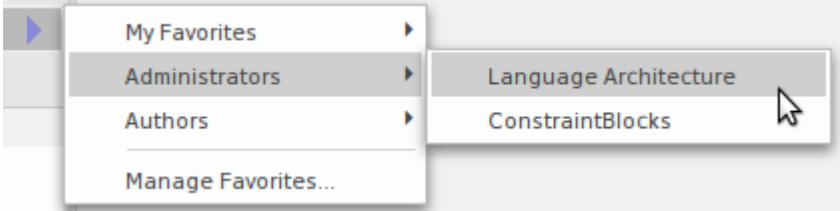
Hamburger	Click on this icon to display a drop-down menu of options to perform various operations on the model, as described in the <i>Menu Options</i> table.
Favorites	<p>This icon shows a menu listing the Packages that you have flagged as 'Favorites' under your own user security ID and the ID of each security group you are a member of. (User security must be enabled for this option to function.)</p> 

Menu Options

Name	Action
Open Project	<p>Select this option to open an existing project, or to create a new project from scratch or from a base template project.</p> <p>Shortcut: Ctrl+O</p>
Reload Project	<p>Select this option to close and reload the current project, refreshing the Browser window (in a multi-user environment, to bring in changes made by other users sharing the project).</p> <p>Shortcut: Ctrl+Shift+F11</p>
New Model From Pattern	<p>Select this option to create a new Model Package in the project, underneath a the selected Package.</p> <p>Shortcut: Ctrl+Shift+M</p>
New Package	<p>Select this option to create a new child Package under the selected Package.</p>
New Diagram	<p>Select this option to create a new child diagram under the selected Package or element.</p>
New Element	<p>Select this option to create a new child element under the selected Package or element and, if required, add it to the currently-open diagram.</p>
Find in Browser	<p>Select this option to perform a simple Element Name search on a text string to locate the element in the Browser window.</p>
Documentation	<p>Select this option to display a submenu from which you can select to generate, on the selected Package in the Browser window, a:</p> <ul style="list-style-type: none"> • Document report (F8) • Web report (Shift+F8) • Joomla! Article or • Diagram Only report (Ctrl+Shift+F8)

Code Generation	<p>Select this option to display a submenu from which you can select to:</p> <ul style="list-style-type: none">• Generate source code (Ctrl+Alt+K)• Generate DDL• Import a source directory (Ctrl+Shift+U)• Import a binary module• Import a Resource Script• Import a database schema• Generate Package contents to synchronize with Package code (Ctrl+Alt+M)• Reset the source code language <p>All these options operate on the selected Package.</p>
-----------------	--

Browser - Context

In the Browser window, the 'Context' tab provides a simplified, focused view of a section of the model, separated from the full structure. This helps you to concentrate on the area of the model you are working on, and is very useful when you are re-organizing that section as it reduces the risk of dragging objects into the wrong area of the model.

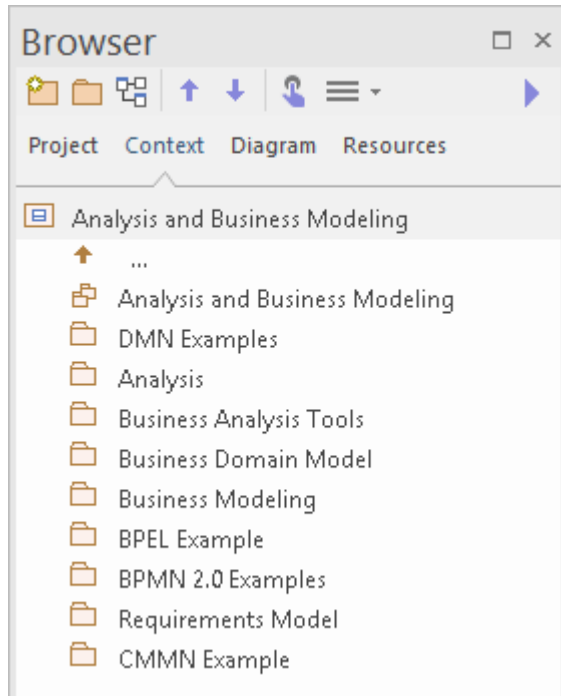



Access

Ribbon	Start > Application > Design > Browser > Context Explore > Portals > Windows > Explore > Context Browser
Keyboard Shortcuts	Ctrl+1 > Context Alt+1 Browser > Context

Functionality

The tab shows the View, Package or element currently selected in the 'Project' tab, and its subordinate objects. It also displays the child objects of subordinate elements, but not of subordinate Packages. To display the child objects of one of these Packages, you double-click on it to make it the focus of the tab.

If the selected object is a Package or element without child objects, or a diagram, the tab has that object's parent in focus at the top, rather than the object itself.

If the currently selected object is not a model Root Node, then the second item in the 'Context' tab is a   icon. Double-clicking on this switches focus to the next level up in the model.

Clicking on an object in the 'Context' tab will cause Enterprise Architect to navigate to that object, displaying its properties and features in other windows that are open.

Double-clicking on a child object that itself has subordinate objects in the 'Context' tab makes that object the focus of the tab, displaying it at the top of the tab. If it does not contain other objects, the 'Properties' dialog displays.

Right-clicking on an object in the 'Context' tab displays the same context menu as in the 'Project' tab of the Browser window.

The 'Context' tab works very well in combination with the Navigator toolbar, which displays the full hierarchy path of any object you highlight in the 'Context' tab. As you change the object in focus on one of these tools, the other is automatically updated as well. The 'Context' tab is another view of the selected section of the model, and any changes you make through the tab are reflected in all other views of the model, such as the 'Project' tab.

If you decide to change the name of a Package, diagram or element on the 'Context' tab, you can simply click on it and press F2. This makes the name editable, and you can quickly overwrite it.

Browser - Diagram

The 'Diagram' tab of the Browser window is a simple list of all elements used in the currently-open and in-focus diagram, including elements that are hidden or in Packages other than the diagram's parent. It also shows the relationships issuing from or terminating at each element.

The 'Diagram' tab is a useful tool for establishing the content of a diagram, especially a large diagram, and selecting an object in the 'Diagram' tab brings that object into focus in other windows and views, including in the diagram itself and in the other tabs of the Browser window. You can therefore instantly expose many details of the object's properties and location.

In many cases, the 'Diagram' tab shows a flat list of elements, but when elements (other than Packages) in the diagram contain other elements the 'Diagram' tab illustrates that hierarchy as shown here.

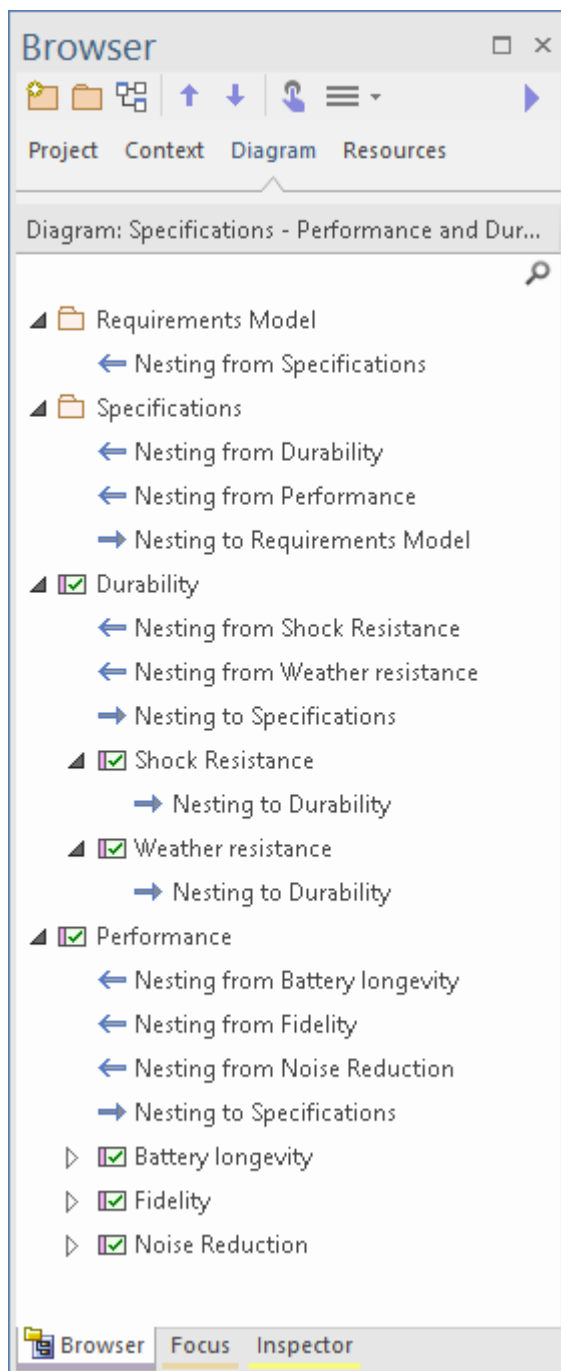

The 'Diagram' tab has context menu options to display, where appropriate for the selected element or connector:

- The 'Properties' dialog
- The docked Properties window
- The Special Action dialog for the element (or, if one is not appropriate, the 'Properties' dialog)
- The 'Element Usage' dialog to show in which other diagrams the element is used
- The Notes window
- The Quick Notes panel
- The Linked Document editor

The 'Diagram' tab also has a Filter Bar that you can use to refine the display to list specific elements. To switch between exposing the Filter Bar and hiding it, right-click on the 'Diagram Items' heading and select the 'Toggle Filter Bar' option.

Access

With an open diagram in view:

Ribbon	Start > Application > Design > Browser > Diagram Explore > Portals > Windows > Project Browser > Diagram
Keyboard Shortcuts	Ctrl+1 > Diagram Alt+1 Browser > Diagram

Browser - Resources

The 'Resources' tab of the Browser window is a repository of project-standard and re-usable document publishing templates, MDG Technologies, Relationship Matrix profiles, commonly-used model elements, stylesheets, UML Profiles and Patterns. The tab provides facilities for creating and modifying these structures and facilities and, in many cases, for applying the facility to the current model directly from the window.

Access

Ribbon	Start > All Windows > Design > Explore > Browse > Resources Explore > Portals > Windows > Explore > Resources Settings > Reference Data > Resources
Keyboard Shortcuts	Alt+6

Resources available through the Resources tab

Notes

- In the Corporate, Unified and Ultimate Editions of Enterprise Architect, if security is enabled you must have 'Configure Resources' permission to maintain 'Resources' tab items
- For a number of folders in the 'Resources' tab, the right-click context menu also offers a 'Help' option that, when you select it, displays a brief description of the folder

Resource	Description
Document Publishing	<p>The <i>Document Publishing</i> folder holds three sub-folders, each of which provides the facilities for generating a particular type of document or report from your model.</p> <ul style="list-style-type: none"> • <i>Report Library</i> - this folder contains the Resource documents (report specifications) you have created in the Document Report Generator, and where appropriate held under document group sub-folders; you can right-click on the document name to generate documents individually or as a batch, open the generated document, or delete the report specification • <i>System Templates</i> - this subfolder contains system-defined report templates, Fragments, Cover Pages, Style Sheets and Table of Contents definitions. You can right-click on these template names and select options to display the template contents or to copy the template as the basis of a custom (user-defined) template that you work on in the Document Template Editor, under a different name; you can also select the 'Override' option to create a copy of the system template as a user template with the same name • <i>Custom Templates</i> - this sub-folder also has sub-folders for report templates, Fragments, Cover Pages, Style Sheets and Tables of Contents, but these are the templates that you have created yourself using the Document Template Editor, either as new or by copying and editing another template. You can right-click on these template names and select options to create, delete, rename, modify, move or copy a user-defined template; you have additional options to mark a report template as a Fragment, or a Fragment as a report template, if they are suitable for this reclassification. You can also 'drag and drop' user-defined templates between user-defined

	groups, and between these groups and the appropriate standard 'type' folders; for example, from 'DavidCover' to 'Cover Pages'
Linked Documents	<p>This folder holds the Linked Document templates, either system provided, user-defined for the Model, or supplied with each MDG Technology that is enabled on the system. You can edit or delete any of the existing Model or MDG Templates, or create new ones from scratch or by copying an existing template - including copying the system-provided Linked Document templates.</p> <p>You can also re-assign the templates to different template groups, either another of the existing groups or a new one that you create as part of the assignment.</p>
Dynamic Documents	<p>The <i>Dynamic Documents</i> folder contains the user-defined style templates for generating dynamic documents on selected elements. The document is automatically generated when you select the element in the 'Dynamic Document' view, having specified the template to apply.</p>
HTML Publishing	<p>This folder contains the HTML style templates that you have created as alternatives to the system-supplied <default> template.</p> <p>To create a new template, right-click on the folder name and select the 'Create HTML template' option, then provide a template name; this opens the HTML and CSS Style Editor, in which you create the template from HTML fragments.</p> <p>You can right-click on the template names and select options to delete the template or modify the template contents.</p>
MDG Technologies	<p>The <i>MDG Technologies</i> folder lists the MDG Technologies that have been imported directly into the 'Resources' tab. Each technology extends the modeling capabilities and facilities of Enterprise Architect. System Technologies are those provided with Enterprise Architect, and Addin Technologies are those deployed from an installed Add-In.</p> <p>You can import Technologies into your project by right-clicking on the <i>MDG Technologies</i> folder and selecting the 'Import Technology' menu option. The 'Import MDG Technology' dialog then gives you the option to import the Technology to:</p> <ul style="list-style-type: none"> • 'User' Technologies, for your individual use • 'Model' Technologies, for all project users to access (this folder originally contained all Technologies imported into the model) <p>The User Technologies folder provides a facility for locating the technology files on the system.</p> <p>If you have any MDG Technologies in a folder, the Technology can be expanded to show its contents, which can include:</p> <ul style="list-style-type: none"> • UML Profiles: <ul style="list-style-type: none"> - Displays the list of non-abstract stereotypes in each profile from the technology - Each stereotype will be displayed with their icon, if one is specified in the profile - Allows you to create stereotyped elements and connectors on a diagram; drag the element stereotype from the folder onto the diagram to create an element, and click on the connector stereotype and drag between elements to create the connector • Diagram Types: <ul style="list-style-type: none"> - Displays the list of diagram profiles for the technology • Layouts: <ul style="list-style-type: none"> - Displays the list of workspace layouts defined by the technology

	<ul style="list-style-type: none"> - Allows you to select and apply a layout • Linked Document Templates: <ul style="list-style-type: none"> - Displays the list of linked document templates defined by the technology - Allows you to view each template and create a copy of it for customization 1. Model Templates: <ul style="list-style-type: none"> - Displays the list of model templates defined by the technology - Allows you to open the 'Model Builder' dialog with a specific template selected, if available in the current Perspective • Scripts: <ul style="list-style-type: none"> - Displays the list of scripts defined by the technology - Allows you to select and run any of the scripts in the Scripting window • Toolboxes: <ul style="list-style-type: none"> - Displays the list of toolbox pages defined by the technology - Allows you to open any of the toolbox pages in the Diagram Toolbox, regardless of the current Perspective <p>You can right-click on these structures and select options to delete the Technology, review the Patterns or Profiles, or invoke the code modules.</p> <p>If you remove the Technology, it is removed from the 'Resources' tab of the Browser window, the 'MDG Technologies' dialog, and the model.</p> <p>Consider the fact that some MDG Technologies can be large and might impose some delays on the workstation as they load each time a user connects to the model.</p>
<p>Model Patterns</p>	<p>The <i>Model Patterns</i> folder holds Model Patterns that have been imported into the model from external sources, including those developed within your own organization. Each Pattern XML file will have a matching .rtf file to explain the Pattern to users. Model Patterns generate modeling structures (Packages, diagrams and elements) within your model.</p>
<p>Matrix Profiles</p>	<p>The <i>Matrix Profiles</i> folder contains a list of Relationship Matrix Profiles that you or your team members have created using the Relationship Matrix or Specification Manager. You simply double-click on a Matrix Profile name to quickly open the Relationship Matrix under the settings defined in the Profile.</p>
<p>Favorites</p>	<p>Deprecated, from Release 15.2.</p> <p>This feature originally provided a shortcut to each commonly-used element that you added to the folder, so that you could quickly and easily locate those elements in the Browser window. There are now other features that enable you to identify specific elements in a similar or even better way, such as:</p> <ul style="list-style-type: none"> • Focus Window, 'Model Views' tab, Favorites View folder • Focus window, 'Working Sets' tab • The Browser window 'Add as Favorite to' context menu option <p>If you have previously stored Favorites in the Resources window Favorites folder, you can locate them again by creating and running a search using this SQL text:</p> <pre>SELECT t_object.ea_guid AS CLASSGUID, t_object.Object_Type AS CLASSTYPE, t_object.Name AS Element, t_object.Object_Type AS [Type],t_object.Stereotype, t_object.Author, t_object.Scope, t_object.Status, t_object.Phase, t_object.CreatedDate, t_object.ModifiedDate FROM t_object, t_xref</pre>

	<p>WHERE <code>t_xref.[Type]='favorite'</code> and <code>t_object.ea_guid = t_xref.Supplier</code> Order By <code>t_object.Object_Type, t_object.Name</code></p>
XSL Stylesheets	<p>The <i>XSL Stylesheets</i> folder contains XSL stylesheets that you or your team members have imported into the model. These XSL stylesheets support the optional step of converting XMI files exported from the model into alternative formats such as HTML, XSL or source code. Stylesheets imported here are then available in the drop-down lists on the 'Publish Model Package' dialog and the 'Generate GML Application Schema' dialog.</p> <p>Combined with UML Profiles, this is an effective means of extending Enterprise Architect to generate almost any content required.</p> <p>To import a stylesheet:</p> <ol style="list-style-type: none"> 1. Right-click on the folder name and select the 'Import Stylesheet' option. 2. Locate and select the stylesheet file in the browser, and click on the Open button. 3. Provide a reference name for the file, and click on the OK button. <p>Once the stylesheet is in the folder, you can select context menu options to reload it (if it has been changed at the source) or delete it.</p>
UML Profiles	<p>A Profile is a source of modified or extended element and connector types that you have developed from the UML base types. You can import each new Profile into this folder, and then create elements and connectors of the new types by dragging the icons from the Profile onto a diagram.</p> <p>Once you have Profiles in the folder, you can select options for arranging them in order of name or type, viewing a Profile description, or deleting a Profile.</p> <p>It is possible to synchronize the Tagged Values and constraints for any elements created from a Profile element in the 'Resources' tab.</p> <p>Importing and applying Profiles through the 'Resources' tab is not recommended; it is recommended that you load and apply Profiles as components of MDG Technologies.</p>
Patterns	<p>The <i>Patterns</i> folder is a folder of Design Patterns that you or your team members have imported into the model. A Pattern captures complex new elements and features that you can drag into a diagram without having to retype or reconfigure each element.</p> <p>Within the folder, the Patterns are grouped by type. Once you have Patterns within a group, you can select options to delete a selected Pattern or all Patterns in the group, view a Pattern's details, or apply a Pattern to an empty diagram.</p>

Hide and Show Browser Tabs

The tabs of the Browser window give you access to every level of your model, from the root nodes and their entire contents in the 'Project' tab through selected Packages and their structure in the 'Context' tab and the elements in an open diagram in the 'Diagram' tab, to the detailed design of a single element in the 'Details' tab of the Inspector window. However, in any one work session you are unlikely to sweep across the full spectrum of your model structure, and it is probably more convenient to refine your work area and the objects listed to show the portion of the model and the type of structure you need to work on.

You can do this by hiding the Browser window tabs that are of less relevance to your task

For example, you might set up a skeleton project structure of Root nodes, Views, Model Packages and Packages, for which you initially would be working on the 'Project' tab and - for the lower levels of the model - the 'Context' tab. You would not need to use the 'Diagram' tab and could hide it.

Conversely, you might have set a large diagram to open automatically when you log on to Enterprise Architect, and spend the whole session working on the elements of that diagram, so you could hide the 'Project' and 'Context' tabs, and just work on the 'Diagram' tab, and/or on the 'Details' tab of the Inspector window.

Hide and Show Tabs

In the tab bar of the Browser window, right-click on the tab you want to hide, and click on the 'Hide Tab' option.

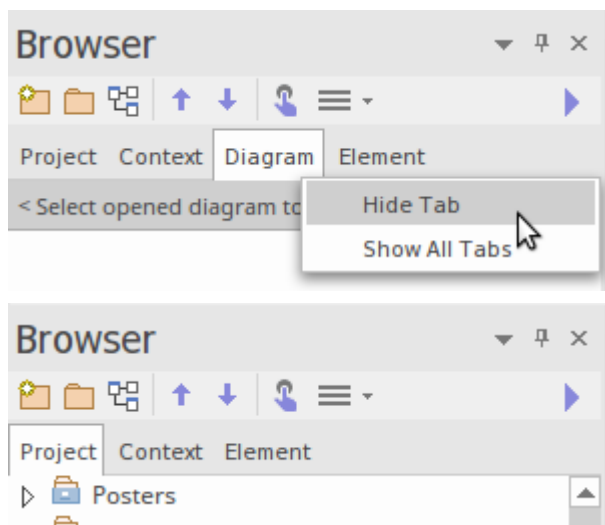

To restore any hidden tabs to the tab bar, right-click on the bar and select the 'Show All Tabs' option.

Model Packages



A Package is a grouping element that acts as a container for other modeling elements (including other Packages) and diagrams; Packages are represented in the Browser window as a familiar folder icon. Using the Package element, you can construct hierarchical models, allowing complex systems to be decomposed and categorized. Packages and their contents can be moved around freely in the Browser window, so that you can easily refactor the repository. Packages can be copied and pasted between model branches, renamed or viewed as a list.

Packages are important in Enterprise Architect because a number of functions can be applied at Package level, such as Baselineing, Version Control, Transformation and more. Formally, the Package is a Namespace for the members it contains, and a model element can be a member of one and only one Package. In software engineering and other formal modeling disciplines a Package can be set as a Namespace Root, which acts as the starting point of a given namespace.

Notes

- In the Corporate, Unified and Ultimate Editions of Enterprise Architect, if security is enabled you must have 'Update Element' permission to update or delete a Package

Annotation

An Annotation Package is a specialized form of Package that is automatically created when a parent Package has one or more diagrams that contain diagrammatic elements - non-model elements that have no purpose outside a diagram. Such elements include Notes, Text, Boundary elements and Navigation Cells. The Package does not have any properties (including not having a name), and is simply a container for those diagrammatic elements, allowing them to be listed in the Browser window and - if necessary - re-used in multiple diagrams. This also protects the elements from being deleted if the diagram that contains them is deleted. The Annotation Package is represented in the Browser Window by a blue Package icon followed by brackets.

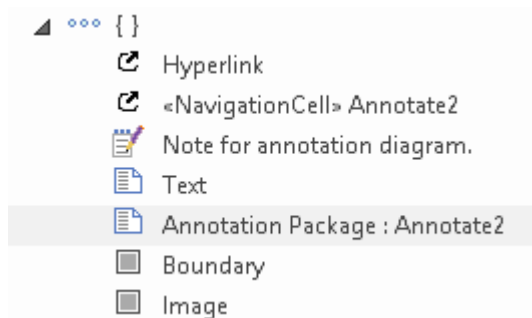

Refine Browser Content

The 'Project' and 'Context' tabs of the Browser window give you access to your entire model structure and sections of the model located in and selected from that entire structure.

However, for more detailed work you would be concentrating on one or more specific Packages, and for multiple Packages you might be working in different areas of the model. Rather than scroll through the whole model to locate and switch between the Packages you need, you can identify those Packages as Favorites and either flip directly to them in the 'Project' tab or - even easier - just call them into the 'Context' tab. This also makes it a lot easier to return to the same area of the model to continue working across several work sessions.

Note that the 'Favorite' Packages are registered against user IDs, so User Security must be enabled for this feature.

This feature is available in the Corporate, Unified and Ultimate Editions of Enterprise Architect, from Release 15.0.

Identify Favorite Packages

To add a Package to a 'Favorites' list, right-click on it in the Browser window and select the 'Add as Favorite to' context menu option. A short menu displays, listing 'Current User' and the security groups to which your user ID has been assigned.

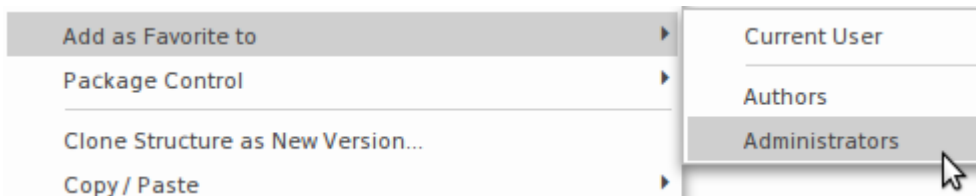

Click on the 'Current User' or appropriate group to add the Package as a 'Favorite' for users who login under that ID.

To see the Packages listed as 'Favorites' for a security group, click on the  icon in the Browser window toolbar, and expand the appropriate group.

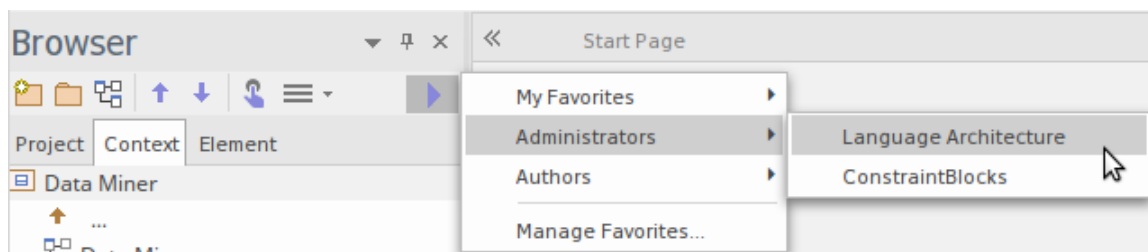

Work on a Favorite Package

You can set focus to a 'Favorite' Package in either the 'Project' tab or the 'Context' tab of the Browser window. Open the required tab, then click on the  icon in the window toolbar, expand the appropriate group and click on the Package name.

- In the 'Project' tab, the Package is located and highlighted in the model structure
- In the 'Context' tab the Package becomes the focus of the tab

If you subsequently select another 'Favorite' Package, that becomes the focus of the open tab, which makes it very easy to select Packages and switch between structurally separated Packages.

Manage Favorites

After you have worked with a 'Favorite' Package for a while, you might not need to focus on it and therefore could remove it from the 'Favorites' list.

To do this, click on the  icon in the Browser window toolbar and select the 'Manage Favorites' option. The 'Manage Favorites dialog displays.

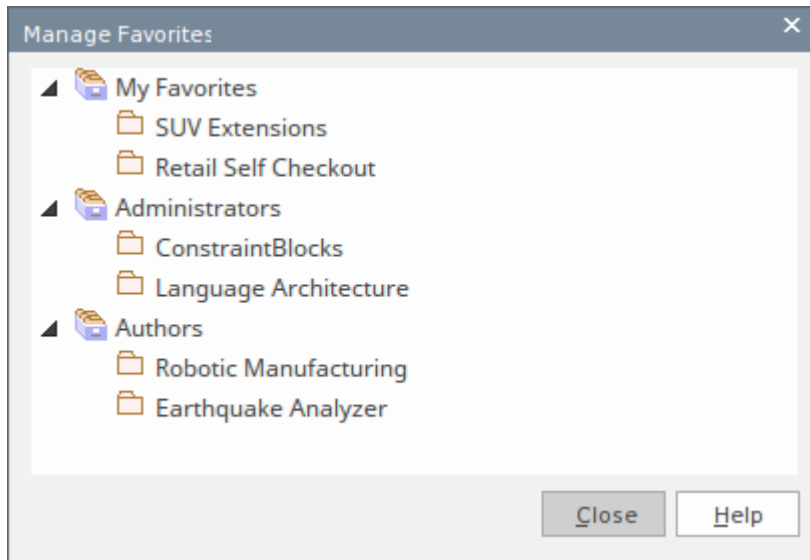

Right click on the Package to remove from the dialog, and click on the 'Remove' option. The Package is immediately removed from the list and is no longer flagged as a 'Favorite'.

Browser Window Context Menus

The Browser window provides a wide range of options to work on the objects it contains. These options are presented through a number of context-sensitive menus.

Model (Root Node) Menu - Browser Window

The Root Node in the Browser window is the Model element. You can have more than one Root Node and hence more than one Model element. The first level Packages beneath the Model node are sometimes referred to as Views, as they commonly divide a model into categories such as Use Case Model and Logical Model. You can perform a wide range of operations on the Model nodes of your project, by selecting options from the Model context menu in the Browser window.

Access

Context Menu	Right-click on the Model Node
--------------	-------------------------------

Options

Option	Action
Specialize	<p>Select this option to access two sets of functions:</p> <ul style="list-style-type: none"> • Scripts - scripts created using the Scripting facility, to be executed on Model Nodes; click on a script name to execute it (this option is not shown if no appropriate scripts have been created) • Extensions - a list of the enabled technologies on the system, each of which provides options for performing technology-specific operations on the Package; these options are available in the Professional, Corporate, Unified and Ultimate Editions of Enterprise Architect
Model Builder (pattern library)	<p>Select this option to add further models using the Model Builder's pattern library. The list of available Model Pattern Technologies includes the MDG Technology Builder (expand the Management group), which creates a Model Package containing templates that you can use to generate a new MDG Technology containing a set of Profiles.</p> <p>Shortcut: Ctrl+Shift+M</p>
Add Root Node	<p>Select this option to create a new model root, without any subordinate structure or content.</p> <p>A prompt for the model name displays.</p>
Add View	<p>Select this option to create a new View (Package) underneath the model root node. The 'Create New View' dialog displays.</p>
Package Control	<p>Select this option to access the Package Control submenu, which provides these options:</p> <ul style="list-style-type: none"> • Lock Package (if the project has User Security enabled); the 'Lock/Unlock Package(s)' dialog displays • Import a Model Branch, and • Version Control Settings

Full Structure for Duplication	Copy the element(s) of the selected Package to the clipboard in XMI format. (Shortcut: Ctrl+Shift+C)
Paste Package from Clipboard	Select this option to paste a child Package from the clipboard into the selected Package.
Clone Structure as New Version	Select this option to build a clone of your current Root Node hierarchy, including diagrams, and update each object with a user defined version number. All diagram elements contained in a clone diagram are included only as linked elements (references).
Delete Project Root	Select this option to delete the Model Root node, after you have already deleted all of its subordinate Views and Packages. A prompt displays for you to confirm the deletion.
Help	Select this option to display the Help topic for the Browser window.

Package Menu - Browser Window

The 'Package' context menu in the Browser window provides a wide range of options for displaying, organizing and operating on the Packages in your model.

Access

Context Menu	Browser window > Project Right-click on Package or View Browser window > Context Right-click on Package or View
--------------	--

Options

Option	Action
Specialize	Select this option to access two sets of functions: <ul style="list-style-type: none"> Scripts - scripts created using the Scripting facility, to be executed on Views and Packages; click on a script name to execute it (this option is not shown if no appropriate scripts have been created) Extensions - a list of the enabled technologies on the system, each of which provides options for performing technology-specific operations on the Package; these options are available in the Professional, Corporate, Unified and Ultimate Editions of Enterprise Architect
Collaborate	Displays a short menu of options to exchange electronic notes with team colleagues, in the form of Reviews, Discussions and Comments, as well as the option to monitor Discussions on the Package.
Properties	Select this option to display the 'Properties' sub-menu for the Package element.
Open Package In	Select this option to display the contents of the Package as a: <ul style="list-style-type: none"> Text description in the Specification Manager List of objects with their selected properties Gantt chart showing resource allocations and progress Construct View, showing task allocations to resources
Import Package as MDG Technology	If the selected Package is an <<mdg technology>>, this option will generate an MDG Technology from the selected Package and any <<profile>>, <<toolbox profile>> and <<diagram profile>> Packages that it owns, and import it into the current model.
Save Package as MDG Technology	If the selected Package is an <<mdg technology>>, this option will generate an MDG Technology from the selected Package and any <<profile>>, <<toolbox profile>> and <<diagram profile>> Packages that it owns, and save it to an XML file.
Model Builder (pattern	Select this option to add another Model Package to the model or View, using the

library)	Model Builder (Start Page 'Create from Pattern' tab). Shortcut: Ctrl+Shift+M
New Package	Select this option to add another Package to the selected Package. Shortcut: Ctrl+W
New Diagram	Select this option to add a new diagram to the selected Package.
New Element	Select this option to add a new element to the selected Package. Shortcut: Ctrl+M
Add as Favorite To	Click on this option to flag the selected View node, Model Package or Package as a 'Favorite', to be highlighted in the Browser window when selected from a list. A short menu displays, from which you select your user security ID or the security group you are a member of, to access the 'Favorite' Package under.
Package Control	Select this option to access the Package Control submenu, which provides these options: <ul style="list-style-type: none"> • Lock the Package (if the project has User Security enabled) • Import a Model Branch, and • Version Control Settings
Clone Structure as New Version	Select this option to build a clone of your current Package hierarchy, including diagrams, and update each object with a user defined version number. All diagram elements contained in a clone diagram are included only as linked elements (references).
Copy/Paste	Select this option to access a menu of options for copying and moving the Package contents to other areas of the model.
Contents	Select this option to reorganize the Package contents after making changes.
Set View Icon	Select this option to display the 'Set View Icon' dialog, on which you select one of the six standard View-type icons to display beside the View name.
Delete <packagename>	Select this option to delete the selected Package and its contents. A prompt displays to confirm the deletion.
Help	Select this option to display the Help topic for the Browser window.

Properties Sub-Menu

The Package 'Properties' context menu provides a range of options for displaying and updating the properties, notes, Tagged Values and Linked Document of a Package element, and for locating the Package in any diagrams that contain it.

Access

Context Menu	Browser Window Right-click on Package Properties
--------------	--

Options

Option	Description
Properties	Displays the Properties window for the Package element, which you can use to view and modify the element properties.
Notes	Displays the Notes window, showing any notes that have been written for the Package element.
Tagged Values	Displays the 'Tags' tab of the Properties window, showing any Tagged Values (extended properties) that have been created for the Package element.
Linked Document	Displays the 'Linked Document' tab of the Document window showing the Linked Document for the Package, if one exists.

Package Control Sub-Menu

The Package 'Package Control' context menu has two forms:

- The 'Controlled Package' form when the Package is not under Version Control, that provides options for locking a Package, importing a model branch into another model and setting up Version Control
- The 'Package Version Control' form that provides a wider range of options for managing the Package when it is under Version Control

Access

Context Menu	Browser window > Right-click on Package > Package Control
--------------	---

Copy/Paste Sub-Menu

The Package 'Copy/Paste' context menu provides a range of options for copying or moving Packages between parent Packages or between models, within the Browser window. It also provides options for pasting copied elements and diagrams into a Package.

Access

Context Menu	Browser window Right-click on Package Copy/Paste
--------------	--

Options

Option	Action
Cut	Select this option to remove the selected Package from its parent Package, to be pasted under another Package. The selected Package remains where it is until the Paste operation is invoked. Shortcut: Ctrl+X
Paste	Select this option to paste a <i>cut</i> Package under the selected Package. If the selected Package is not a valid target, the 'Paste' option is grayed out. (This option is not available for <i>copied</i> Packages - use the 'Paste Package from Clipboard' context menu option.) Shortcut: Ctrl+V
Copy to Clipboard	Select this option to copy the selected element(s) (including the Package element) to the clipboard. You select one of two sub options: <ul style="list-style-type: none"> ID for Pasting as Link - copy the element IDs to the clipboard to be pasted into a diagram as links to the actual elements (Shortcut: Ctrl+C) Full Structure for Duplication - copy the element(s) of the selected Package to the clipboard, in XMI format for pasting as new duplicate elements in another Package (Shortcut: Ctrl+Shift+C)
Paste Package from Clipboard	Select this option to paste a Package from the clipboard into the selected Package. Shortcut: Ctrl+V
Paste Element(s) from Clipboard	Select this option to paste elements copied to the clipboard into the selected Package. Shortcut: Ctrl+V
Paste Diagram	If you have copied a diagram from another Package, select this option to paste the diagram into the currently-selected Package.
Copy Documentation Bookmark	When using the Legacy Report Generator, if you want to create a complex document that consists of sections of one or more document reports, rather than one complete report, you can create a master document in Microsoft Word™ and within

	<p>it create links to the report sections using their bookmarks.</p> <p>Select this menu option to copy the bookmark on the selected Package to the clipboard, to be pasted into a search or other reference to the bookmark.</p>
Copy Node Path to Clipboard	Select this option to copy the Package's node path (hierarchy structure) to the Enterprise Architect clipboard, as a reference.
Copy Node GUID to Clipboard	Select this option to copy the Package's node GUID to the Enterprise Architect clipboard, as a reference.

Contents Sub-Menu

The 'Contents' sub-menu of the Browser window Package context menu provides options for collapsing and expanding the contents of a Package, bookmarking the elements of a Package, and restoring the default sort order of the Package.

Access

Context Menu	Browser window Right-click on Package Contents
--------------	--

Options

Option	Action
Bookmarks	Select this option to bookmark all elements in the selected folder.
Expand Branch	Select this option to expand the complete contents of this branch of the model.
Collapse Branch	Select this option to collapse all items in this branch of the model.
Reset Sort Order	Select this option to return sorting of Package contents to list the child elements, child Packages and the contents of each child Package, in alphabetical order.
Reload Current Package	Select this option to refresh the current Package in the Browser window.

Element Menu - Browser Window

The element context menu in the Browser window is available for all types of element. It provides options for performing a wide range of operations on both individual elements and multiple elements, including adding element properties and features, and moving the elements around the project or between projects.

There are no context menu options in the 'Diagram' tab.

Access

Context Menu	Browser Window > Project tab Right-click on element Browser Window > Context tab Right-click on element
--------------	--

Options (Single element)

Option	Description
Specialize	Select this option to access two sets of functions: <ul style="list-style-type: none"> Scripts - scripts created using the Scripting facility, to be executed on elements; click on a script name to execute it (this option is not shown if no appropriate scripts have been created) Extensions - a list of the enabled technologies on the system, each of which provides options for performing technology-specific operations on the element; these options are available in the Professional, Corporate, Unified and Ultimate Editions of Enterprise Architect
Collaborate	Select this option to display a short menu of options to exchange electronic notes on the selected element with team colleagues, in the form of Reviews, Discussions and, if User Security is enabled, Chats and Model Mail messages, as well as the option to monitor Discussions on the element.
Properties	Select this option to display the element 'Properties' sub-menu, to view and modify the element properties, notes, Tagged Values and Linked Document.
Features	Select this option to display a short submenu for managing attributes and operations (either in their specific dialogs or via the Features window) and - for a Class element with attributes - to pre-define initial values for attributes that can be used to override existing defaults.
Add	Select this option to access a submenu of options for creating a child element and diagram (Classifier elements) or a connector to another element.
Copy/Paste	Select this option to access a menu of options for copying and moving the Package contents to other areas of the model.
Find in all Diagrams	Locates the element in any diagram that contains it. If the element is in a single diagram, the diagram displays. If the element is not in any diagram, or is in more than one diagram, the 'Element Usage' dialog displays. You can select the diagram

	containing the instance of the element you require. This option also operates on Port and Part Property Type Classifiers.
Locate in Current Diagram	Select this option to select the element in the currently-visible diagram. If the element is not in the diagram, this option is grayed-out.
Lock	Select this option to apply or release a lock for editing the selected element. (The option is displayed only when user security is enabled in User/Group locking mode)
View Audit History	Select this option to open the Audit View to see a history of changes made to the selected element.
Delete <element Name>	Select this option to delete the element. A prompt displays for you to confirm the deletion.
Help	Select this option to display the Help topic for the Browser window.

Options (Multiple elements)

Option	Description
Scripts	Lists any scripts created using the Scripting facility, to be executed on multiple elements; click on a script name to execute it (this option is not shown if no appropriate scripts have been created).
Collaborate	This option displays if User Security is enabled on the model. It provides two suboptions: <ul style="list-style-type: none"> 'Send Message', which displays the 'Create Message' dialog to create and send a message containing a hyperlink to each of the selected objects 'Monitor Discussions', which sets a flag on the element so that if any replies to your discussions or new discussions are posted on the selected elements, a prompt displays in the bottom right of the Enterprise Architect work area
Lock Element(s)	Select this option to apply or release locks for editing the selected elements. (The option is displayed only when user security is enabled in User/Group locking mode).
Generate Documentation	Select this option to display the 'Generate Documentation' dialog, through which you can generate a report on the selected elements.
Copy to Clipboard	Select this option to copy the selected elements to the clipboard. You select one of two sub options: <ul style="list-style-type: none"> ID for Pasting as Link - copy the element IDs to the clipboard to be pasted into a diagram as links to the actual elements (Shortcut: Ctrl+C) Full Structure for Duplication - copy the elements to the clipboard in XMI format, for pasting as new duplicate elements in another Package (Shortcut: Ctrl+Shift+C)
Delete selected item(s)	Select this option to delete the selected group of objects from the Browser window

	and the model. A prompt displays for you to select whether to delete each item in turn (click on the Yes button) or all items together (click on the Yes to All button).
--	--

Properties Sub-Menu

The element 'Properties' context menu provides a range of options for displaying and updating the properties, notes, Tagged Values and Linked Document of an element, and for locating the element in any diagrams that contain it.

Access

Context Menu	Browser window > Project Right-click on element Properties Browser window > Context Right-click on element Properties
--------------	--

Options

Option	Description
Properties	Displays the Properties window for the element, which you can use to view and modify the element properties.
Special Action	Displays either the 'Properties' dialog for the element or, for specialized elements, the dialog that defines their action. For example, if this option is selected for a Checklist Artifact, the 'Checklist Items' dialog displays for defining the checkbox items in the list.
Notes	Displays the Notes window, showing any notes that have been written for the element.
Responsibilities	Displays the Responsibility window, through which you can add and update internal Requirements (Responsibilities), Scenarios and Constraints on the element.
Tagged Values	Displays the Properties window; click on the 'Tags' tab, showing any Tagged Values (extended properties) that have been created for the element.
Summary	<p>Displays the Summary window of the selected element, which provides a brief, read-only summary of the general properties of the currently selected element. Once displayed, the Summary window can also show a:</p> <ul style="list-style-type: none"> • Package • Attribute • Operation • Test • Maintenance item or • Resource <p>The display refreshes immediately as you select different objects and items. You can highlight a section of text or the complete content, and copy it to be pasted into an external document.</p> <p>The Summary window does not display details for Views, Model Packages, diagrams, instances or connectors.</p>

Linked Document	Displays the 'Linked Document' tab of the Document window showing the Linked Document for the element, if one exists.
-----------------	---

Add Sub Menu

The element 'Add' submenu provides a list of appropriate elements that can be added as child elements to the selected element. It also provides options for creating child diagrams, including Composite diagrams, and for adding connectors.

Access

Context Menu	Browser window > Project Right-click on element Add Browser window > Context Right-click on element Add
--------------	--

Options

Option	Description
Port	Select this option to add a Port element to the border of the selected element.
Composite Structure Diagram	Select this option to set the selected element as a Composite Element and create a new Composite Structure diagram (if none exists). If the selected element already contains a child diagram, the existing diagram will instead be referenced as the element's Composite diagram.
Select Composite Diagram	Select this option to set the selected element as Composite and link it to a specified diagram, or to change the currently-linked diagram for another. The linked diagram could exist anywhere within the current repository.
Activity	Select this option to add an Activity behavior element and one of its associated diagrams to the selected classifier element.
Interaction	Select this option to add an Interaction behavior element and one of its associated diagrams to the selected classifier element.
StateMachine	Select this option to add a StateMachine Behavior element and one of its associated diagrams to the selected classifier element.
RuleFlow Activity	Select this option to add a Rule Flow Activity element and associated diagram to a Class, in Business Rule Modeling.
Construction Diagram	Select this option to create a Construction rendition of the element on a Construction diagram. The Construction rendition is a rectangular element outline with a  in the bottom right corner, and compartments automatically enabled; the compartments show various Project Management items with Progress Bars where appropriate, as you define them in the Construct view.
Add Diagram	Select this option to create a diagram to explain or expand on the selected classifier element, using the 'New Diagram' dialog.
	Select this option to set up cross references between elements in a diagram and the

Add Custom Reference	selected element in the Browser window.
Create Link	Select this option to create a connector to another element.

Notes

- Elements such as Actors, Classes and Activities can define a large amount of information that can be conveniently represented by or expanded in a child diagram; the 'Add' sub-menu for these elements provides all of the options listed
- Elements such as Timing, Exit and History have much more specific functions that do not require expansion; the 'Add' sub-menu for these elements only provides the 'Create Link' option

Element Copy/Paste Submenu

The element 'Copy/Paste' context menu provides a range of options for copying or moving elements between Packages or between models, within the Browser window.

Access

Context Menu	Browser Window > Project Right-click on element Copy/Paste Browser Window > Context Right-click on element Copy/Paste
--------------	--

Options

Option	Description
Copy to Clipboard	Select this option to copy the selected element and any sub-structure to the clipboard. You select one of two sub options: <ul style="list-style-type: none"> • ID for Pasting as Link - copy the element ID to the clipboard to be pasted into a diagram as link to the actual element (Shortcut: Ctrl+C) • Full Structure for Duplication - copy the element(s) to the clipboard in XMI format, for pasting as new duplicate elements in another Package (Shortcut: Ctrl+Shift+C)
Cut	Select this option to remove the selected element from its parent Package, to be pasted under another element or Package. The selected element remains where it is until the Paste operation is invoked. Shortcut: Ctrl+X
Paste	Select this option to paste a cut element under the selected element or Package. If the selected element is not a valid target, the 'Paste' option is grayed out. (This option is not available for copied elements - use the 'Paste Package from Clipboard' menu option in the Package context menu.) Shortcut: Ctrl+V
Copy Documentation Bookmark	When using the Legacy Report Generator, if you want to create a complex document that consists of sections of one or more document reports, rather than one complete report, you can create a master document in Microsoft Word™ and within it create links to the report sections using their bookmarks. Select this menu option to copy the bookmark to the clipboard, to be pasted into a search or other reference to the bookmark.
Paste Diagram	Select this option to paste an existing diagram as a child of the selected element. The diagram would have been copied to the clipboard by right-clicking on the diagram in the Browser window and selecting the 'Copy Diagram' menu option.
Copy Node Path to Clipboard	Select this option to copy the element's node path (hierarchy structure) to the Enterprise Architect clipboard, as a reference.

<p>Copy Node GUID to Clipboard</p>	<p>Select this option to copy the element's node GUID to the Enterprise Architect clipboard, as a reference.</p>
------------------------------------	--

Diagram Menu - Browser Window

The diagram context menu in the Browser window is available for all types of diagram listed on the 'Project' or 'Context' tabs. It provides options for performing a wide range of operations on one diagram or several diagrams, and for moving a diagram around the project or between projects.

Access

Context Menu	Browser Window > Project Right-click on Diagram Browser Window > Context Right-click on Diagram
--------------	--

Options

Option	Action
Specialize	Select this option to access two sets of options: <ul style="list-style-type: none"> Scripts - a list of scripts created using the Scripting facility, to be executed on diagrams; click on a script name to execute it (this option is not shown if no appropriate scripts have been created) Extensions - a list of the enabled technologies on the system, each of which provides options for performing technology-specific operations on the diagram; these options are available in the Professional, Corporate, Unified and Ultimate Editions of Enterprise Architect
Collaborate	Select this option to display a short menu of options to exchange electronic notes on the selected diagram with team colleagues, in the form of Reviews, Discussions and, if User Security is enabled, Chats and Model Mail messages, as well as the option to monitor Discussions on the diagram.
Properties	This option provides access to the Properties window for the diagram.
Open	Select this option to open the diagram in the Diagram View. (You can also double-click on the diagram name in the Browser window.)
Lock Diagram	Select this option to display the 'Lock Diagram' dialog, on which you can set, change and release the editing lock on the selected diagram.
Show Diagram Versions	When a diagram is cloned, a custom reference is added to the diagram (in the <code>t_xref</code> table). This custom reference provides information on the clone, through the 'Show Diagram Version' dialog. Select this option to display the 'Show Diagram Versions' dialog.
Copy / Paste	Select this option to access a menu of options for copying and moving the diagram to other areas of the model.
Print Diagram(s)	Select this option to print the currently-selected diagram or diagrams (hold Ctrl or Shift while selecting).

	<p>The 'Print' dialog displays, on which you specify the print parameters.</p> <p>By de-selecting the 'Printable' option on an element on a diagram, you can omit that element and its connectors from the printed diagram.</p> <p>Shortcut: Ctrl+P</p>
Delete '<diagram name>'	<p>Select this option to delete the selected diagram.</p> <p>A prompt displays to confirm the deletion.</p>
Help	<p>Select this option to display the Help topic for the Browser Window.</p>

Diagram Copy/Paste Menu

The diagram 'Copy/Paste' context menu provides a range of options for copying or moving diagrams between Packages or between models, within the Browser window.

Access

Context Menu	Browser Window > Project Right-click on diagram Copy/Paste Browser Window > Context Right-click on diagram Copy/Paste
--------------	--

Options

Option	Action
Cut	Select this option to remove the selected diagram from its current location, to be pasted under another Package or element. The selected diagram remains where it is until the 'Paste Diagram' operation is invoked. To paste the diagram, use the: <ul style="list-style-type: none"> 'Copy/Paste Paste Diagram' option on the Package context menu, or element context menu Shortcut: Ctrl+X
Paste	Not used.
Copy Diagram	Select this option to copy the diagram for pasting into another location.
Copy Documentation Bookmark	When using the Legacy Report Generator, if you want to create a complex document that consists of sections of one or more document reports, rather than one complete report, you can create a master document in Microsoft Word™ and within it create links to the report sections using their bookmarks. Select this menu option to copy a bookmark on the diagram to the clipboard, to be pasted into a search or other reference to the bookmark.
Copy Node Path to Clipboard	Select this option to copy the diagram's node path (hierarchy structure) to the Enterprise Architect clipboard, as a reference.
Copy Node GUID to Clipboard	Select this option to copy the diagram's GUID to the Enterprise Architect clipboard, as a reference.

Operation/Attribute Menu - Browser Window

The separate but almost identical 'Operation' and 'Attribute' context menus in the Browser window provide options for performing a number of tasks on the features (operations and attributes) of an element.

Access

Context Menu	Browser window > Project Right-click on Feature Browser window > Context Right-click on Feature
--------------	--

Options







Option	Action
Specialize	Provides access to two sets of functions: <ul style="list-style-type: none"> Scripts - scripts created using the Scripting facility, to be executed on attributes and operations; click on a script name to execute it (this option is not shown if no appropriate scripts have been created) Extensions - a list of the enabled technologies on the system, each of which provides options for performing technology-specific operations on the attribute or operation; these options are available in the Professional, Corporate, Unified and Ultimate Editions of Enterprise Architect
Collaborate	Select this option to display a short menu of sub-options to exchange electronic notes on the parent element of the feature with team colleagues, in the form of Reviews, Discussions and, if User Security is enabled, Chats and Model Mail messages, as well as the option to monitor Discussions on the parent.
Properties	Displays a short sub-menu providing these options: <ul style="list-style-type: none"> Properties - Displays the Properties window showing details for the selected feature Notes - Displays the notes recorded on the feature, in the Notes window Tagged Values - Displays the Tagged Values recorded for the feature, in the 'Tags' tab of the Properties window All Features - Displays the Features window to access other types of feature on the same parent element
Copy Reference	Select this option to copy a reference to the feature to the Enterprise Architect clipboard. Select the appropriate sub-option to copy the: <ul style="list-style-type: none"> Selected hierarchy structure (Node Path) Node GUID
View Source Code	Select this option to open the Source Code Viewer and display the code for the feature.

	Shortcut: F12
Cut	Select this option to cut the feature from its current element and paste it into another element. The feature does not move from the original element until you paste it into the target. Use the element 'Copy/Paste Paste' menu option to paste the feature into its new parent.
Paste	Not used.
Delete Attribute / Operation	Select this option to delete the feature. The feature is immediately removed from the element.
Help	Select this option to display the Help topic for the Browser window.

Browser Window Icon Overlays

The Browser window displays the status of each Package in the model by overlaying status icons on the Package icon. The meaning of each overlaid icon is provided here.

Icon Overlays

Icon Overlay	Indicates that...
	This Package is controlled and is represented by an XMI file; Version Control either is not being used or is not available. You can edit the Package.
	This Package is Version Controlled and checked out to you, therefore you can edit the Package.
	This Package is Version Controlled and not checked out to you, therefore you cannot edit the Package unless you check the Package out.
	This Package is Version Controlled, but you checked it out whilst not connected to the Version Control server. You can edit the Package but there could be version conflicts when you check the Package in again.
	This Package is a namespace root, which denotes where the namespace structure starts; Packages below this point are generated as namespaces to code.
	The version-controlled Package has been flagged as Read Only, using a Package control method applied through the Automation Interface - as a script, for example. The padlock icon displays with other Package control icons except for the 'blue box' (third item in the list), which takes precedence. The Read Only flag can be applied to Packages whether they are checked-in or checked-out.
	MDG Add-Ins can specify their own icon to denote that this branch of the model belongs to that Add-In. All Packages connected to an MDG Add-In correspond to a namespace root, so the namespace root icon is not displayed.

Feature Scope

Similarly, the Browser window indicates attribute and operation scope status with icons.

Icon Overlay	Indicates that...
	The attribute or operation is scoped as protected.

	The attribute or operation is scoped as private.
---	--

Notes

- In the Corporate, Unified and Ultimate Editions, if project User Security is on, the Browser window also has element locking indicators (red and blue exclamation marks) that indicate the lock status of individual elements and Packages
The availability of these elements for editing depends on whether user locks are required or not

Order Package Contents

Ordering elements is very important when it comes to structuring your model, especially Packages. Report documents honor any custom ordering when printing documentation. You can change the order of elements listed in the Browser window.

By default, elements are first listed in:

- Order of type, then
- Order of set position, then
- Alphabetically

You can use the Browser window toolbar arrows to move an element up or down within its type, but not outside its type. This means you can re-sequence Packages or diagrams or Use Cases, but you cannot mix up elements.

However, you can change this default behavior to allow elements to be re-ordered within the Package, regardless of type.

Set Default Behavior

The 'General' page of the 'Preferences' dialog provides options for altering the behavior of the Browser window.

Access

Ribbon	Start > Appearance > Preferences > Preferences > General
--------	--

Options

Panel	Option
Browser Window	<p>Select the appropriate checkboxes to engage particular facilities in the Browser window:</p> <ul style="list-style-type: none"> 'Confirm Deletes' - (Operates on the 'Project' and 'Context' tabs) This checkbox defaults to selected to display a confirmation prompt whenever you delete a model component; only clear the checkbox to bypass the prompt if you are an experienced user and have taken other measures to identify and recover from accidental deletes 'Free Sorting' - (Operates on the 'Project' and 'Context' tabs) Select this checkbox to be able to re-order elements listed within a Package regardless of type, in the Browser window 'Show Stereotypes' - (Operates on the 'Project' tab) Select this checkbox to display element stereotype names in front of the element name, in the Browser window (you must shut down and restart Enterprise Architect for this change in setting to take effect); you assign a stereotype to an element in its 'Properties' dialog

The Properties Window

The docked Properties window provides a convenient and immediate way to view and edit the properties of a wide range of modeling objects and features such as diagrams, elements, connectors, attributes, operations, receptions, responsibilities, maintenance items, project items and tests. The tabs and fields displayed depend on the selected object; this illustration shows the 'Element' tab of the window, which displays when you click on a Class element.

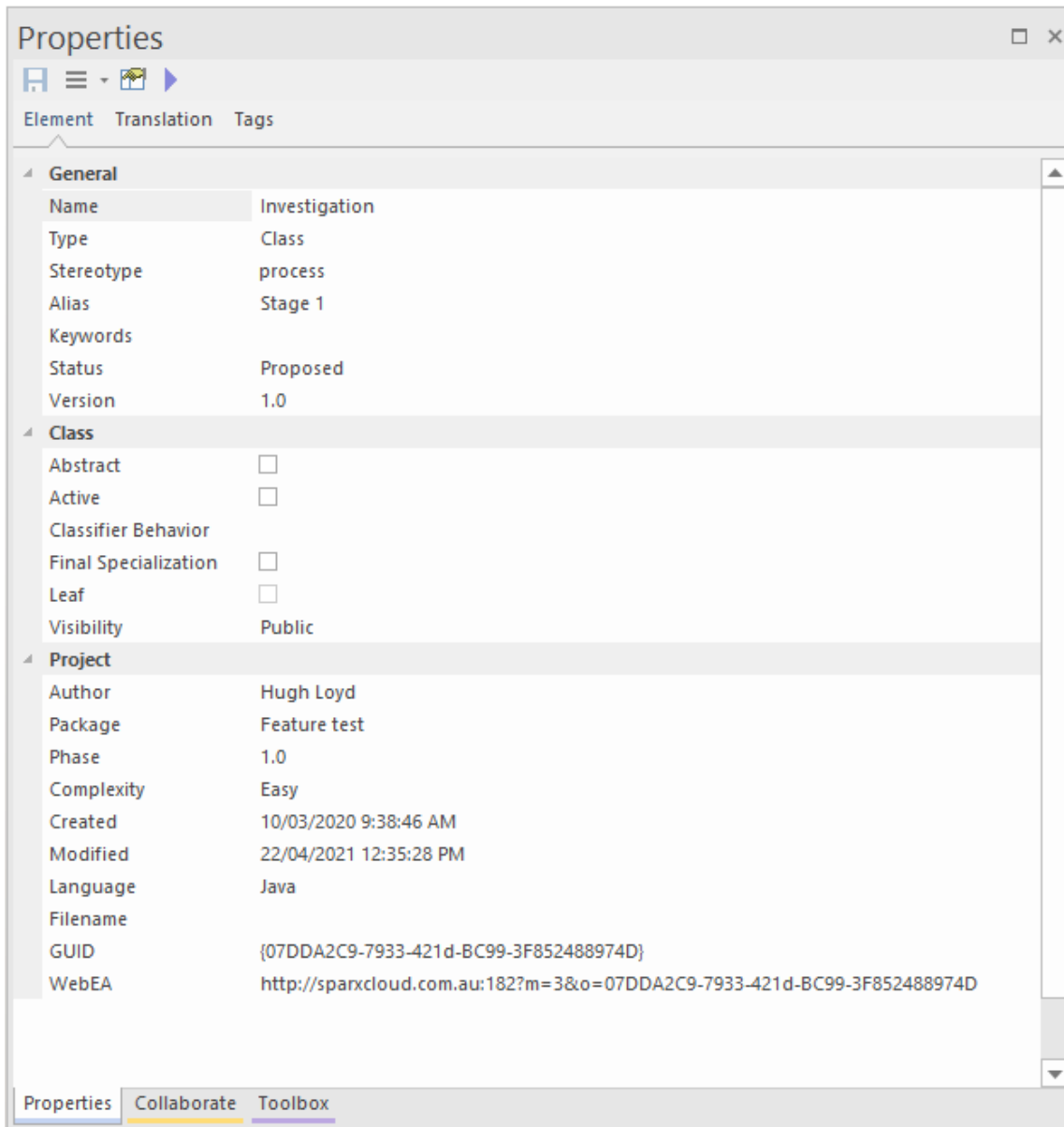

When you click on an object in the Browser window or a diagram, the Properties window immediately shows that object's properties, so you can swiftly display the properties of a sequence of objects of different types - element, then attribute, connector and diagram - on the same window without having to open and close separate dialogs.

Each iteration of the window shows the general properties, such as name, object type and status, and properties appropriate to the stereotype, technology, object type and project management. In many cases there is a series of additional tabs appropriate to the specific type of object displayed. These are illustrated in the Help topic describing the window for each selected object type.

To complete fields you can select values from drop-down lists and work through short chains of property or parameter dialogs directly from the Properties window. Your work with modeling objects becomes quick, precise, comprehensive and convenient, through the use of a single area of your work space.

If you are working with an external data source in a Cloud-connected model, you can also view the details of an external

data item on a variant of the Properties window, with an 'External' tab. See the *External Item Details* Help topic.

Access

Ribbon	Start > All Windows > Properties > General > Properties Design > Element > Properties > General > Properties
Keyboard Shortcuts	Ctrl+2 Ctrl+Enter Alt+1 Properties Alt+5 Properties

Properties Window Options

The Properties window has a toolbar providing a number of options for operating on the object you have displayed in the window, as described in this table.

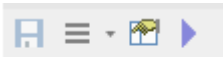

Option	Description
Save	Click on this icon to save any changes you have made to the fields on any tab of the Properties window.
Hamburger	Lists several options for acting on the selected object; several of these options apply only when you are looking at element properties. <ul style="list-style-type: none"> Find in Project Browser - Locates and highlights the current object in the Browser window Element Properties - If you are displaying the properties of an element, displays the 'Properties' dialog for the element Diagram Properties - If you are displaying the properties of a diagram, displays the 'Properties' dialog for the diagram Operations - If the current element is capable of having operations, opens the Features window at the 'Operations' tab, to show the operations of the element. Attributes - If the current element is capable of having attributes, opens the Features window at the 'Attributes' tab, to show the attributes of the element. Receptions - If the current element is capable of having Receptions, opens the Features window at the 'Receptions' tab, to show the Receptions of the element Set Parents - If the current element can have interfaces and parent elements, opens the 'Set Parents and Interfaces' dialog Show Groups - Select or deselect this option to partition the element Properties into groups (such as 'General Settings', 'Project' and 'Advanced'), or present them all in one continuous list. Help - Select this option to display the Help topic appropriate to the tab of the Properties window that you have selected

Switch Display	Click on this option to open the 'Properties' <i>dialog</i> for the selected object.
Special Action	Click on this icon to display the appropriate special action or special properties dialog for the selected object; if there is no special action display, the standard 'Properties' dialog displays.

Notes

- When you click on a field name, a brief summary of that field displays at the bottom of the Properties window, unless you have selected the 'Hide Properties Info Section' checkbox on the 'Window Behavior' page of the 'Preferences' dialog
- If you click on the field value for an editable field, either a drop-down arrow or a  button displays that enables you to select or browse for a different value; one of the values offered might display a more advanced list or a dialog for adding new objects or selecting multiple objects, as the 'Stereotype' field does

Properties Window for Diagrams

The docked Properties window provides a convenient and immediate way to view and edit properties of modeling objects, including diagrams. When the Properties window is open and you click on an open diagram, the window defines the diagram, displaying the common properties and providing an associated 'Compartments' tab.

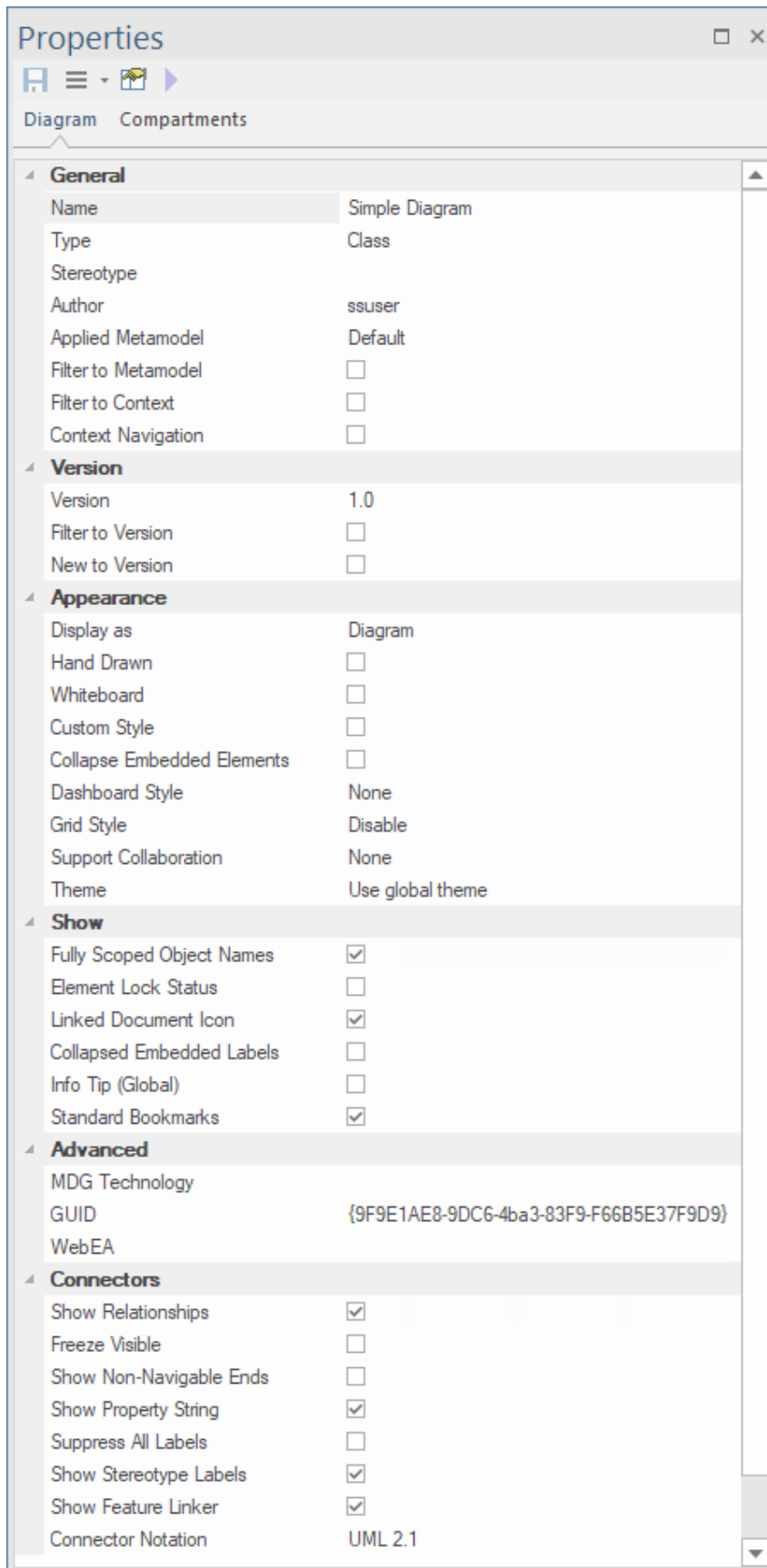

As you review the properties for the diagram, you can edit the values by overtyping them, or by clicking on the drop-down arrow or browse button to select alternative values.

If you click on a diagram name in the Browser window, you can edit some of the common properties in the Properties

window; however, most of the fields are available for editing only when the diagram is open and selected.

Access

Ribbon	<p>After selecting the Properties window using one of these methods, click on the first required diagram.</p> <p>Start > Application > Design > Properties or Explore > Portals > Windows > Properties > Properties</p>
Keyboard Shortcuts	<p>Ctrl+2 or Ctrl+Enter Alt+1 > Properties</p>

Properties Window Tabs

Tab	Description
Diagram Tab	<p>The 'Diagram' tab provides a number of checkbox fields that make it simple to define what the diagram shows and how the objects are presented. You can also tailor certain fields that were assigned default values when the diagram was created. For further details, see the <i>Diagram Tab</i> Help topic.</p> <p>You can also define properties on the diagram's 'Properties' dialog.</p>
Compartments Tab	<p>This tab provides a list of the simple compartments that you can display in elements included in the current diagram. Some types of element are automatically displayed in rectangular notation, whilst others might have to be set manually in rectangular notation to show the compartments.</p> <p>Click the check box against each compartment to show in the elements on the diagram:</p> <ul style="list-style-type: none"> • Attributes • Operations • Tags • Requirements • Constraints • Testing • Maintenance • Discussions • Reviews • Resources • Package Contents • Project • Notes • Receptions <p>For further information on these compartments and others you might set on the diagram, see the <i>Compartments</i> and <i>Define Element Characteristics</i> Help topics.</p>

Properties Window - Diagram

The 'Diagram' tab of the Properties window provides a number of fields and options you can set to define what the diagram shows and how the objects are presented.





Access

Ribbon	Click on the required diagram and then display the Properties window using one of these methods: Start > Application > Design > Properties > Diagram Design > Element > Editors > Properties > Diagram
Keyboard Shortcuts	Ctrl+2 > Diagram Alt+1 > Properties > Diagram Alt+5 > Properties > Diagram

Diagram Properties

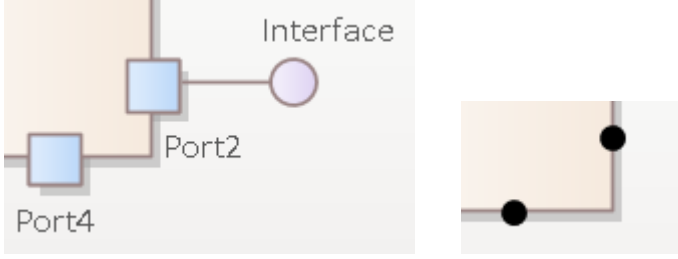
Field	Description
Name	Defaults to the name of the parent Package as the name of the diagram. If necessary, you can edit the name or overtype it with a new name.
Type	Displays the diagram type. You cannot edit this field.
Stereotype	(Optional) Type in the name of a diagram stereotype to apply, or click on the drop-down arrow and select a stereotype from the list. You can define stereotypes to select here using the 'Settings > Reference Data > UML Types' ribbon option, selecting the 'Stereotypes' page and creating stereotypes with a 'Base Class' of 'Diagram'.
Applied Metamodel	Displays the name of the diagram View or specialization. If necessary, click on the drop-down arrow at the right of the field and select a different View.
Author	Defaults to the name of the person who created the diagram. If necessary, you can overtype this or click on the drop-down arrow and select an alternative name from the list.
Filter to Context	Select this checkbox to filter the diagram to 'fade' all elements that have no relationships with the selected element (the context element), so that only those in the relationship group are apparent.
Filter to Metamodel	Select this checkbox to filter the diagram to 'fade' all elements that are not derived from the same View as the selected element.
Context Navigation	This option operates on the 'Context' tab of the Browser window, and Package

	<p>elements in the diagram. When you select the checkbox and click on a Package element, the Package becomes the focus of the 'Context' tab and you can click on and expand the Package contents in the tab.</p> <p>If you clear the checkbox, clicking on the diagram content has no effect on the 'Context' tab.</p>
Version	<p>Displays the version number of the diagram. This defaults to 1.0 when the diagram is created, and you update the version manually according to the conventions applied in your workplace.</p>
Filter to Version	<p>Select this checkbox to filter the elements on the diagram and mute those that do not have the same version number as the diagram. This is of particular value when you are working on the elements of a cloned diagram and want to distinguish between elements that have been cloned to match the diagram and Package structure, and elements that are still the same version as the source.</p> <p>You can use the facility to check more generally which elements are not of the same version as the diagram, such as when you drag elements from the Browser window as links to local or, more especially, external elements.</p>
New to Version	<p>Select this checkbox to set the version of every new element added to the diagram to the same version as the diagram. Elements dragged and dropped from the Diagram Toolbox or added using the 'New Element' dialog will have the same version as the diagram. The version value of elements dragged and dropped from the Browser window will not be updated.</p>
Display as	<p>Use this field to display an alternative view of the diagram. Click on the drop-down arrow and select:</p> <ul style="list-style-type: none"> • Diagram - to show the default graphical view of the diagram • Specification - to show the elements on the current diagram in the Specification Manager • List - to show the diagram as a list of elements (Diagram List) • Gantt - to show the elements on the diagram and resource allocations against them in a Gantt chart • Relation Matrix - to show a graphical relationship matrix for the elements on the diagram • Construct View - to show the elements on the diagram and project management information attached to them in a grid view
Hand Drawn	<p>Select this checkbox to display the diagram contents as if they had been roughly drawn by hand.</p>
Whiteboard	<p>Select this checkbox to display the diagram as if it had been drawn on a whiteboard, with white fill and background.</p>
Custom Style	<p>Select this checkbox to turn on diagram custom style. Clear the checkbox to revert to normal notation. Changes to this checkbox are reflected in the 'Custom Draw' checkbox in the diagram 'Properties' dialog, and vice versa.</p>
Collapse Embedded Elements	<p>Reduces edge-mounted structural elements to black dots on the parent element border, on the current diagram. Each black dot represents one structural element or one hierarchy of elements; for example, a Port with an Interface collapses to one dot.</p>

	 <p>This simplifies the information presented by the diagram, when the structural elements are currently not the focus of interest.</p> <p>You can move the dot representing a structural element, but you cannot create new structural elements or connectors involving structural elements on the diagram whilst this option is in use.</p>
<p>Dashboard Style</p>	<p>Designed to operate on Dashboard (Chart) diagrams, to lay out Chart elements in a logical sequence. Click on the drop-down arrow and select the style to apply.</p> <p>This option will operate on diagrams of types other than Dashboard, but the effect might not be as useful.</p>
<p>Grid Style</p>	<p>Click on the drop-down arrow and select 'Enable' to apply the Grid style, 'Disable' to cancel the Grid style, and 'Edit' to define or update the style.</p>
<p>Support Collaboration</p>	<p>Select a value to flag elements on this diagram where monitoring for new messages has been turned on for:</p> <ul style="list-style-type: none"> • Elements that are the subject of Discussions • Chat messages to specific user groups (Chat messages to individual users are automatically monitored) <p>If an element is the subject of a monitored Discussion, and an unread message is in the 'Discuss' tab of the Discuss & Review window, the  icon displays against the element on the diagram.</p> <p>Each monitored Chat group or user should be represented by an Actor element on the diagram. If a user or a member of a group sends a Chat message, the  icon displays against the appropriate Actor element on the diagram.</p> <p>There are four options:</p> <ul style="list-style-type: none"> • None - to turn Collaboration support off so that no notification icons display (any other option turns Collaboration support on for Discussions) • With Alias - for Chat messages, to check the Actor elements to locate the one that has the poster's user ID or group ID in the 'Alias' field • With Locking User - for Chat messages, to check the Actor elements for the one that has been locked under the poster's user ID or group ID • With Both - for Chat messages, to check firstly for the user ID that locked the element and, if that is not found, for the 'Alias' field containing the poster's user ID
<p>Theme</p>	<p>Click on the drop-down arrow and select the theme to apply to the current diagram. The field defaults to the value 'Use global theme', which applies the theme selected on the 'Diagram > Theme' page of the model 'Preferences' dialog.</p>
<p>Fully scoped object names</p>	<p>Select this checkbox to disable the use of fully scoped object names for elements in this diagram.</p>
<p>Element Lock Status</p>	<p>Select this checkbox to add a locking indicator ( or ) outside the top left corner</p>

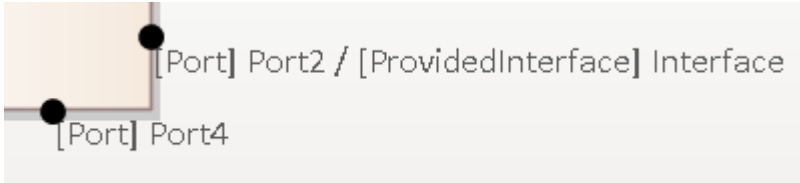
	<p>of each locked element on the diagram.</p> <p>If the element is:</p> <ul style="list-style-type: none"> • Fully locked or locked by another user, the indicator is red • Locked by you or by another user in the same user group as you, the indicator is blue • Not locked, no indicator displays
Linked Document Icon	Select this checkbox to allow elements on the diagram that have Linked Documents to display the Linked Document icon (A). Clear the checkbox to hide the icon.
Collapsed Embedded Labels	<p>If embedded elements have been collapsed, you can select this option to display labels identifying the collapsed elements on the diagram by name.</p> 
Info Tip (Global)	<p>For all diagrams in the model, display a tooltip containing element property information when you move the cursor over an element in the diagram. Setting or clearing this checkbox for one diagram sets or clears the checkbox in every other diagram in the model.</p> <p>If this checkbox is not selected, diagram tooltips are not displayed.</p> <p>The type of property information to display is defined in the 'Tooltips' panel at the bottom of the 'Diagram' tab of the 'Preferences' dialog.</p>
Standard Bookmarks	Selecting/deselecting this option will show/hide all standard bookmarks on the current diagram.
MDG Technology	If the diagram is part of a model created for an MDG Technology, this field displays the name of that technology
GUID	Read-only field, displaying the GUID of the selected diagram.
WebEA	<p>If your organization uses WebEA on the Pro Cloud Server, it is likely that the 'Advanced' section of the 'Diagram' tab will have this field automatically filled with the https address of the diagram for access by WebEA; this field is enabled by the Project Administrator, setting the model's web address in the 'URL' field of the 'Cloud' page of the 'Manage Model Options' dialog.</p> <p>The WebEA diagram address is a composite of the model URL, the model number in WebEA, and the diagram's GUID.</p>
Show Relationships	Defaults to selected to show relationships on the diagram. To hide all relationships on the diagram, click on the checkbox to clear it.
Freeze Visible	Click on the checkbox to select it, to freeze the diagram to show only the connectors that are visible on this diagram at this point. Connectors that are subsequently created on other diagrams between the same elements are not added to this diagram until the option is deselected and the diagram is refreshed.
Show Non-Navigable Ends	Click on the checkbox to select it, to indicate when Association Ends are not navigable; a cross is shown on each non-navigable end of an Association connector.

Show Property String	Click on this checkbox to select it, to show the property strings (constraint text) for connectors.
Suppress All Labels	Click on the checkbox to select it, to hide all connector labels on the diagram.
Show Stereotype Labels	Click on the checkbox to select it, to show a label on each connector indicating the connector's stereotype. Click on the checkbox again to clear it, to hide these stereotype labels.
Connector Notation	Click on the drop-down arrow and select the required connector notation: <ul style="list-style-type: none">• UML 2.1 - use the standard UML 2.1 notation for connectors (the default)• Information Engineering - use the Information Engineering (IE) connection style• IDEFX1 - use the Integrated Definition Methods IDEFX1 connection style

Notes

- In the Corporate, Unified and Ultimate Editions of Enterprise Architect, if security is enabled you must have 'Update Diagrams' permission to update diagram properties

Properties Window for Elements

The docked Properties window provides a convenient and immediate way to view and edit properties of modeling objects such as elements. When the Properties window is open and you click on an element in a diagram or in the Browser window, the Properties window displays the general properties and usually provides specialized tabs appropriate to the particular type of element. For example:

- Port and Part elements have a 'Property' tab and a 'Redefined/Subsetted' tab
- Class and Signal elements simply have an 'Element' tab, a 'Translation' tab and a 'Tags' tab
- Objects have a 'Run States' tab
- Activity elements have 'Behavior', 'Parameters', and 'Partitions' tabs
- Action and Invocation elements (depending on their type) have 'Action', 'Trigger', 'Behavior', 'Arguments' and 'Call' tabs
- Action Pins have a 'Pin' tab
- Checklists have a 'Checklist' tab
- System Boundaries have a 'Boundary' tab on which you define the element appearance

The specialized tabs are described in the Help where each specific type of element is discussed. Not all tabs and fields on the Properties window are currently documented for all element types. The principal tab for elements is the 'Element' tab.

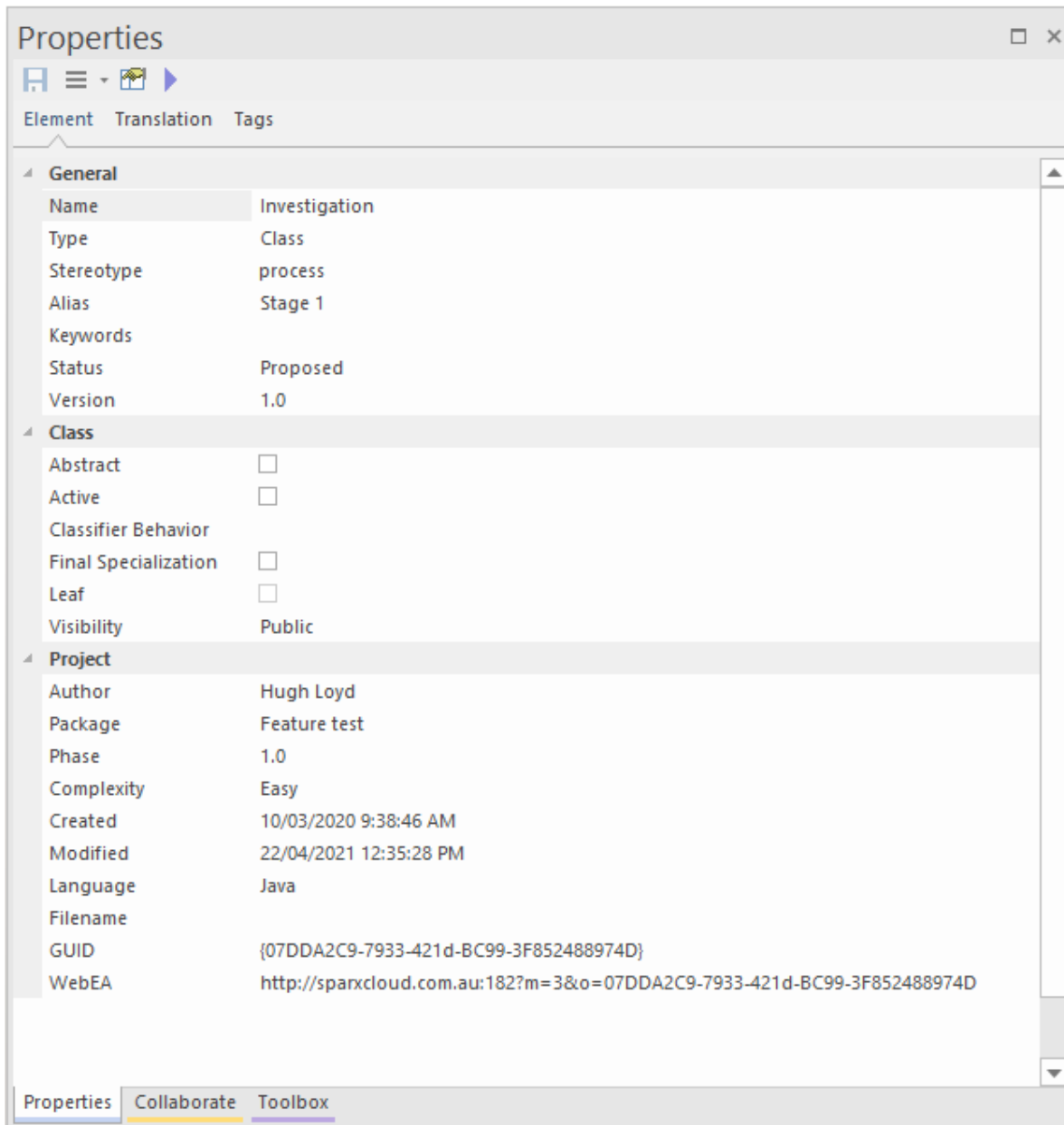

For information on this tab, please refer to the *Element Tab* Help topic. The 'Translation' tab is described in the *Translation Facilities* Help topic, and the 'Tags' tab is described in the *Tagged Values* Help topic.

As you review the properties for an element, you can edit the values by overtyping them, or by clicking on the drop-down arrow or browse button to select alternative values.

Access

Ribbon	<p>After selecting the Properties window using one of these methods, click on the first required element.</p> <p>Start > Application > Design > Properties or Design > Element > Editors > Properties or Explore > Portals > Windows > Properties > Properties</p>
Keyboard Shortcuts	<p>Ctrl+2 Ctrl+Enter</p>

	Alt+1 Properties Alt+5 Properties
--	--

Notes

- If your organization uses WebEA on the Pro Cloud Server, it is likely that the 'Project' section of the 'Element' page will have a 'WebEA' field showing the https address of the element for access by WebEA; this field is enabled by the Project Administrator, setting the model's web address in the 'URL' field of the 'Cloud' page of the 'Manage Model Options' dialog, and is automatically filled with a composite of the model URL, the model number in WebEA, and the diagram's GUID

Properties Window - Element

The 'Element' tab of the Properties window displays the properties fields for the currently selected element of any type, with the properties grouped as General, Technology, Base Element Type and Project. For some element types it is the only page shown. If the fields are not displayed, click on the white arrow head next to each group name to expand the group.

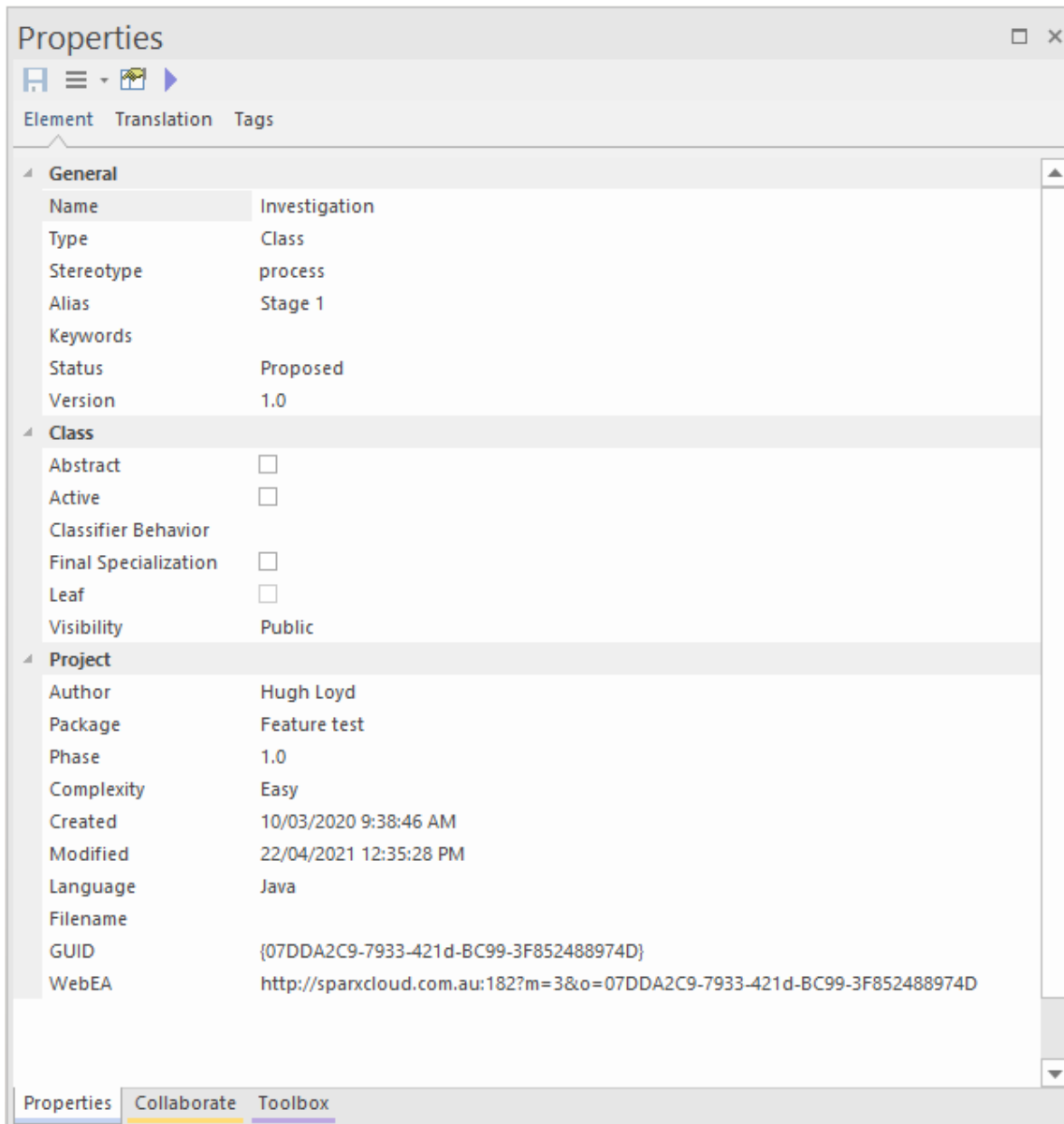

To add or change the value of a field, you can either:

- Overtyping the field with the required value
- Clicking on the drop-down arrow to select from a list of appropriate values or
- Clicking on the button at the end of the field to search the model for an appropriate classifier

Access

--	--

Ribbon	Start > Application > Design > Properties Design > Element > Editors > Properties
Keyboard Shortcuts	Ctrl+2 > Element

Element Properties

Option	Description
Name	<p>This field displays the element's name that, for a new element, defaults to either:</p> <ul style="list-style-type: none"> • <element type><number of elements of this type already in the Package> (for example, Class3) or • A name conforming to the auto-naming/numbering convention you have defined <p>If necessary, overwrite the default name with a different name.</p>
Type	Displays the element type, such as Class or Use Case.
Stereotype	<p>(Optional) Displays the stereotype (if any) assigned to the element. The stereotype name is prefixed by its parent profile name.</p> <p>If the element has multiple stereotypes, they are listed on separate lines of the field.</p>
Role	(Optional, for an Object element) Displays the role played by the object represented by the element.
Alias	(Optional, for elements other than an Object element) Displays the alias or alternative display name for the element, if any.
Keywords	(Optional) Displays any significant terms that the element might be associated with and that might be filtered on to identify the element in Use Case Metrics and Searches.
Status	Displays the current management status of the element (such as Approved or Proposed).
Version	Displays the current version of the element (defaults to the value specified on the 'Objects' page of the Preferences window, such as 1.0 or 2.3, but you can type in any alphanumeric string that meets your requirements).
Priority	<p>Displays the relative importance of meeting this Requirement, Change, Issue or Feature compared to other elements of the same type:</p> <ul style="list-style-type: none"> • Low • Medium • High
Difficulty	<p>Displays an estimate of the difficulty in meeting the Requirement, Feature, Change or Issue defined by the element:</p> <ul style="list-style-type: none"> • Low

	<ul style="list-style-type: none"> • Medium • High
Multiplicity	Identifies the number of instances of the element that can exist in a set; the value displays on the element in a diagram, in the 'Name' compartment.
Visibility	Displays the element's exposure for access ('Public', 'Private', 'Protected' or 'Package').
Leaf	Identifies whether or not the element is final, so it cannot be a parent for other elements.
Abstract	Identifies whether or not the element is abstract.
Classifier	Displays the name of the element that acts as a classifier for the selected element.
Author	This field defaults to the user ID of the person who created the element. If necessary, you can type in a different user ID, or click on the drop-down arrow and select one.
Package	Identifies the parent Package of the selected element.
Phase	Displays the current phase of the element (defaults to the value specified on the 'Objects' page of the Preferences window, such as 1.0 or 2.3, but you can type in any alphanumeric string that meets your requirements).
Complexity	<p>Displays the element's development complexity (used for project estimation). There are normally three levels:</p> <ul style="list-style-type: none"> • Easy • Medium • Difficult <p>However, you can change your user defaults to add 'Extreme' and 'Unknown' to this list of options.</p>
Created	Displays the date and time the element was created.
Modified	Displays the date and time the element was most recently modified.
Language	<p>Defaults to the programming language defined for the model (in the 'Default Language for Code Generation' field on the 'Source Code Engineering' page of the 'Preferences' dialog).</p> <p>If this element is required to have a different language, click on the drop-down arrow and select it. If the element is not language-specific, select '<none>'.</p>
Filename	(Optional) If you intend to generate code from the element, click on the  button to the right of the field and create or select the name and location of the file into which the code will be generated.
GUID	Displays the automatically-assigned Globally Unique Identifier of the element. You can check this GUID and copy it for reference in many of your modeling tasks.
WebEA	If your organization uses WebEA on the Pro Cloud Server, it is likely that the

	<p>'Element' tab will have this field automatically filled with the https address of the element for access by WebEA; it can be copied and used as a hyperlink to access the element. This field is enabled by the Project Administrator, setting the model's web address in the 'URL' field of the 'Cloud' page of the 'Manage Model Options' dialog.</p> <p>The WebEA element address is a composite of the model URL, the model number in WebEA, and the element's GUID.</p>
Is Root	Identifies whether or not the element is a root element that cannot be descended from another element.
Is Specification	Identifies whether or not the element is a specification.
Persistence	Identifies whether the element is persistent or transient, or neither (blank).
Base Type	Displays the base type of element of which the selected element is an extension.
Exclude from Generated Reports	For a Package element, indicates whether or not the Package and its contents will be excluded from any reports generated on this Package's parent Package.

Properties Window and Dialog for Connectors

A connector can have a wide range of properties, with some connector types having fewer, simpler properties and others having more and more-complex properties. You edit these properties on either the:

- Properties window for the connector or the
- '<connector type> Properties' dialog

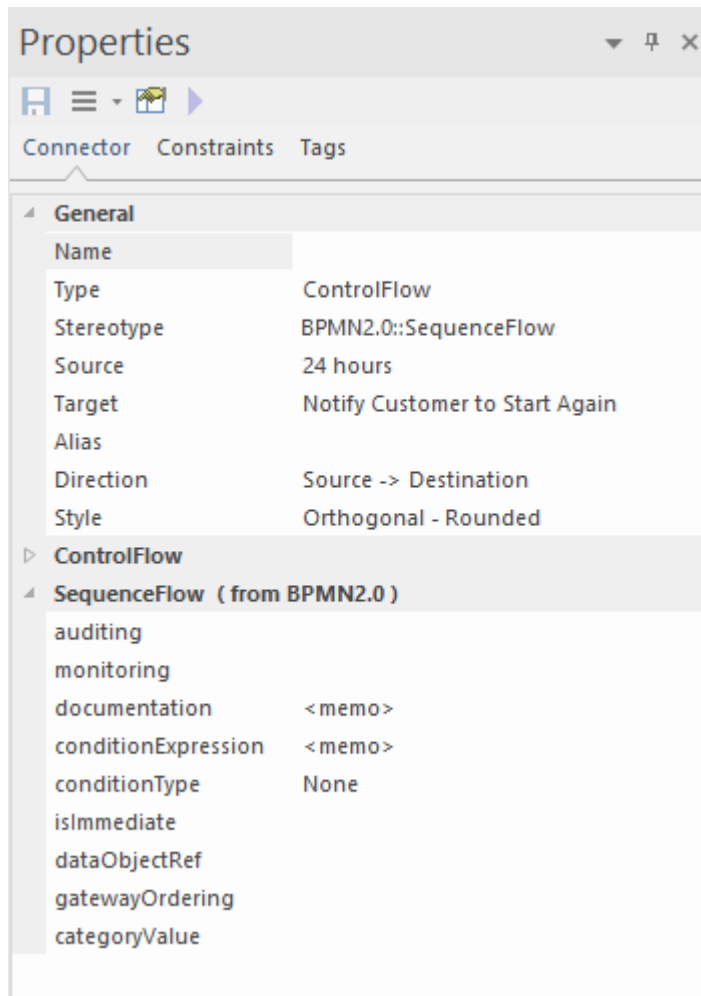

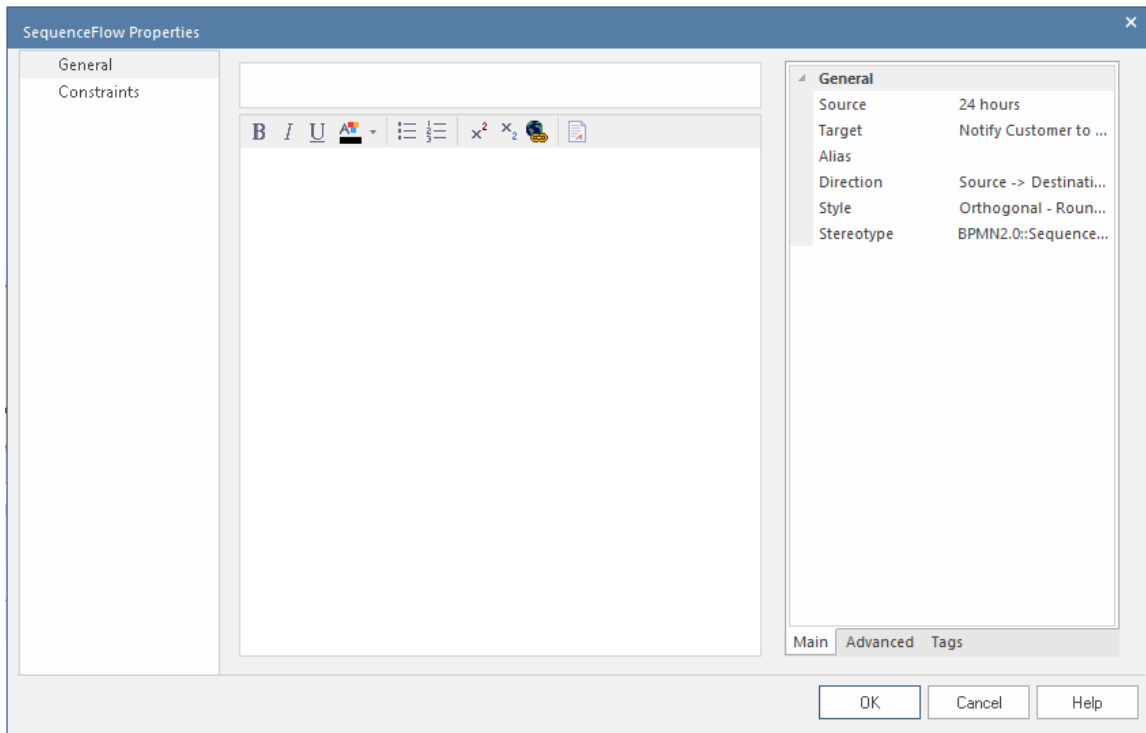

Some properties are visible on a diagram as text labels on or around the connector, and you can change these labels using the 'Label' context menu.

The connector properties are presented on these tabs:

- Connector - defining General and (in the Properties window) type-specific properties
- Advanced properties - type-specific properties on the 'Properties' dialog
- Source and Target Roles
- Constraints
- Template Bindings (where appropriate)
- Tags (Tagged Values) - On the Properties window, type-specific and metatype Tagged Values are shown on the 'Connector' tab; on the dialog all tags are shown on the 'Tags' tab

Access

Ribbon	Start > Application > Design > Common > Properties > click on connector in a diagram > Connector (Properties window) Design > Element > Editors > Element > Properties > click on connector in a diagram > Connector (Properties window)
Context Menu	Right-click on Connector Properties ('Properties' dialog)
Keyboard Shortcuts	Ctrl+2 > Connector (Properties window)
Other	Double-click on Connector ('Properties' dialog)

General Options

These options are available on the 'Connector' tab and 'General' grouping of the Properties window, or the 'General > Main' tab of the 'Properties' dialog.

Option	Action
Name	(Optional) Type a representative name for the connector; this name displays on the diagram.
Notes	('Properties' dialog, Optional) Type any comments you want to record on the connector. You can format the text using the Notes toolbar at the top of the field. These notes can be included in searches, reports and documentation, if required.
Type	(Properties window) Displays the connector type selected when creating the connector.
Stereotype	(Optional) Type the name of a stereotype for the connector, or click on the  button and select the stereotype from the 'Stereotypes for <object name>' dialog. If specified, the stereotype is displayed on the diagram and it over-rides the connector type in the report documentation. If necessary, you can add multiple stereotypes, each in a separate line of the field.
Source	Displays the name of the source element for the connector.
Target	Displays the name of the target element for the connector.
Alias	(Optional) Type an alternative name or alias for the connector.
Direction	Displays the direction of the connector. For some connectors (such as an Association), you can change the direction: click on the drop-down arrow and select the appropriate direction details - from source to destination, destination to source, bi-directional, or unspecified. Some connectors have arrow heads that depend on this setting, and some connectors are logically dependent on it (such as Inheritance).
Style	Click on the drop-down arrow and select the appropriate connection style; choose from: <ul style="list-style-type: none"> • Direct • Auto-Routing • Custom • Tree (Vertical, Horizontal, Lateral Vertical or Lateral Horizontal), or • Orthogonal (Square Corners or Rounded Corners) Some connectors can also have the Bezier style, under which the connector follows a smooth curve.
Virtual Inheritance	(For Generalization connectors) Click on the drop-down arrow and select True or False to indicate if inheritance is virtual or not.
Scope	(For Generalization connectors where the child Class is C++.) Click on the drop-down arrow and select the appropriate value for the scope (used for inheritance).

Notes

- Instead of displaying properties on tabs in the 'Properties' dialog, you can display the properties on screen pages selected through a hierarchical list; select the 'Property Sheets use Tree style' checkbox using the 'Start > Appearance > Visual Style' ribbon option
- The 'Binding' tab is displayed for Generalize, Realize, Associate and Template Binding connectors; use this tab to define binding expressions and parameter substitutions for the connector

Connector Advanced (Dialog)

The connector 'Properties' dialog has an 'Advanced' tab on the 'General' page, which you use to reset the values of any system-defined advanced properties that the connector has.

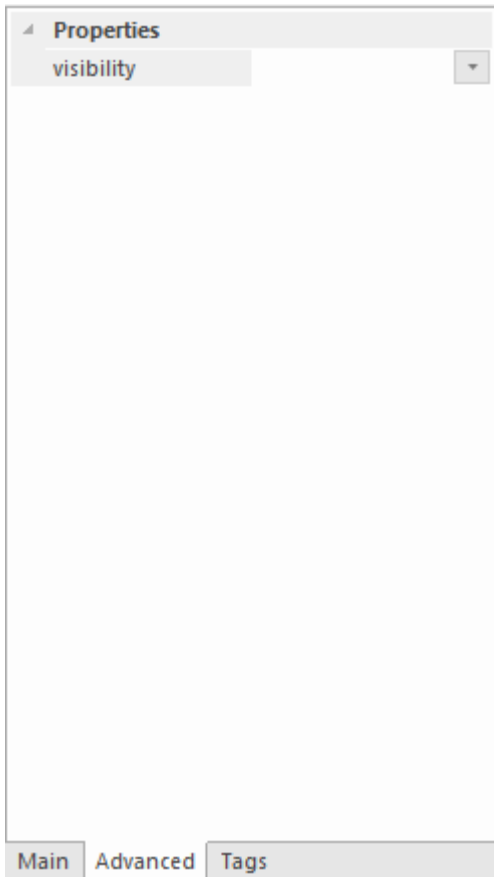

Access

Context Menu	Right-click on Connector Properties > General > Advanced
Other	Double-click on Connector > General > Advanced

Set a value for a connector's advanced property

Step	Action
1	Click on the data field to the right of the property name.
2	Depending on the property, either: <ul style="list-style-type: none">• Type the value in free text• Click on the drop-down arrow and select the value from the list

	<ul style="list-style-type: none">Click on the  button and search for the required value
3	Click on the OK button.

Connector Tagged Values

You can define Tagged Values for a connector and, for Association and Aggregation connectors, set additional Tagged Values for the source role and/or target role.

You can set these Tagged Values separately on the 'Tags' tab of the Properties window or 'Properties' dialog.

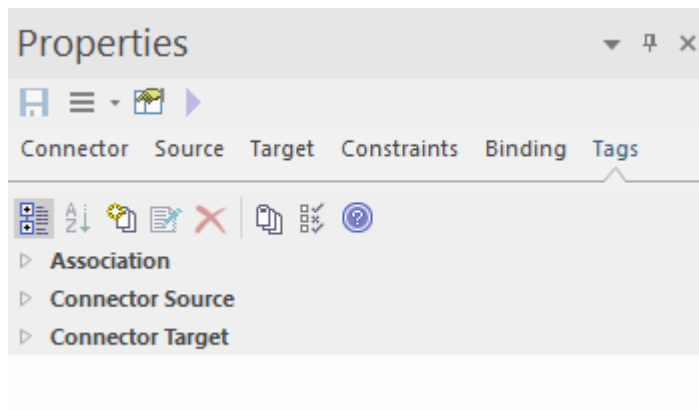

Access

Ribbon	Start > All Windows > Properties > General > Tagged Values > click on the connector on the diagram (Properties window)
Context Menu	Right-click on Connector Properties > General > Tags ('Properties' dialog)
Other	Double-click on Connector > General > Tags ('Properties' dialog)

Set Tagged Values for the connector

Step	Action
1	Click on the connector type name, Connector Source or Connector Target as required.
2	Either click on the  icon in the toolbar, or press Ctrl+N. The 'Tagged Value' dialog displays.
3	In the 'Tag' field type the tag name, or click on the drop-down arrow and select a predefined Tagged Value type.
4	In the 'Value' field, type the value for the tag.
5	Click on the OK button to save the changes and close the dialog. The Tagged Value is displayed under the object type you selected in step 1.

Source and Target Role

For certain types of connector, such as Association or Aggregation, the elements at either end of the connector can have defined roles. You define the roles in the:

- Connector 'Properties' dialog, on the 'Role(s)' tab, which has separate panels for the Source and Target role definitions, or
- The Properties window for the connector, on the 'Source' and 'Target' tabs

The field descriptions here are the same for both source and target roles. This illustration shows the panels from the 'Properties' dialog; the Properties window tabs are almost identical.

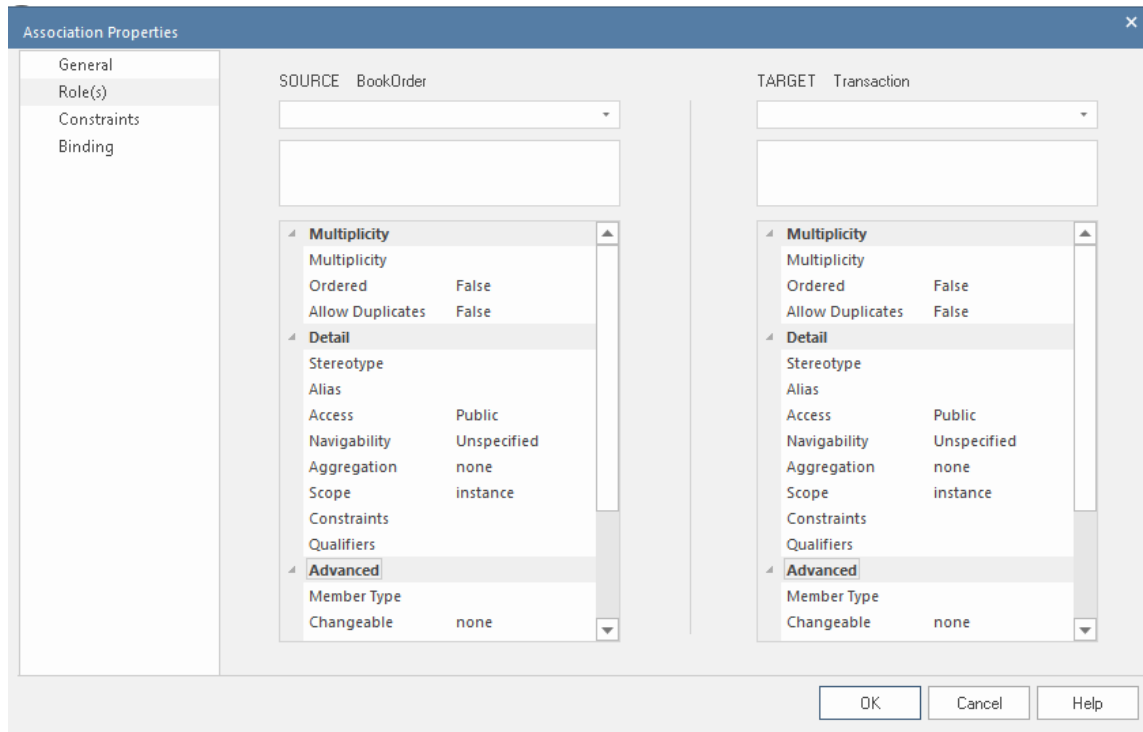



Access

Ribbon	Start > Application > Design > Properties > click on connector in a diagram > Source or Target (Properties window) Design > Element > Editors > Properties > click on connector in a diagram > Source or Target (Properties window)
Context Menu	Right-click on Connector Properties > Role(s) (connector 'Properties' dialog)
Keyboard shortcuts	Ctrl+2 > click on connector in a diagram > Source or Target (Properties window)
Other	Double-click on Connector > Role(s) (connector 'Properties' dialog)

Enter Role Definitions

Option	Action
<top field>	Type the name of the role assigned to the element. Alternatively, click on the drop-down arrow and select an attribute name from the opposite element (that is, select the source role name from the names of attributes on the target element, and vice versa).
<second field>	Type any notes required to describe the role.
MULTIPLICITY	
Multiplicity	Click on the drop-down arrow and select the required multiplicity for the role (you can edit the possible values of this field on the 'Cardinality' tab of the 'UML Types' dialog). Multiplicity is the range of instances of the role that can be active in the relationship - for example, one employee can be assigned to one or more tasks; for the target role you define the range of instances (such as tasks) that the employee could be assigned to. The values have these formats: <ul style="list-style-type: none"> • *, or 0..* - zero, one or many instances • 0..n - zero or up to n instances, but no more than n • n - exactly n instances • n..* - n, or more than n instances You can also define source and target role multiplicity in the corresponding element's attribute properties.
Ordered	Click on the drop-down list and select True or False to indicate whether or not the role is an ordered list.
Allow Duplicates	Click on the drop-down list and select True or False to indicate that the role can contain duplicate elements (relevant only if multiplicity is > 1). This field maps to the UML property 'isUnique' (selecting the checkbox maps to the 'isUnique' value of False).
DETAIL	
Stereotype	(Optional) Type the name of a stereotype that applies to this end of the connector, or click on the  button at the end of the field and select a stereotype from the 'Stereotypes for <object name>' dialog.
Alias	(Optional) Type in an alias for the role.
(Level of) Access	Click on the drop-down arrow and select the appropriate access level for the role.
Navigability	Click on the drop-down arrow and select a value to indicate whether or not this role is navigable (whether non-navigable ends are shown on the diagram depends on the diagram properties).
Aggregation	Click on the drop-down arrow and select a value to indicate the type of aggregation that this role uses.

Scope	Click on the drop-down arrow and select a value to indicate the level (instance or classifier) at which this role applies.
Constraints	Type the names of any constraints on the role.
Qualifier(s)	Type the names of any qualifiers or restrictions on the role; separate multiple qualifiers with a semi-colon. Alternatively, click on the  button at the end of the field, and define a new qualifier on the 'Qualifiers' dialog (qualifiers typed into the 'Qualifiers' field are also automatically added to this dialog).
ADVANCED	
Member Type	Type the name of a role-type that can be used when generating Collection Classes for multiplicity > 1.
Changeable	Click on the drop-down arrow and select a value to indicate whether this role is subject to change.
Containment	Click on the drop-down arrow and select a value to indicate the nature of the containment at the Destination (Reference or Value).
Derived	Click on the drop-down arrow and select True or False to indicate whether the role value or values can be computed from other information.
Derived Union	Click on the drop-down arrow and indicate whether the role is derived from the properties that subset it (that is, derived from a strict union of all properties that are constrained to subset it). To change this flag, type 'F' or 'T' in the field, as appropriate. As an example, you might set this field to True for a Class 'Schoolbus' with an attribute 'Passengers [0..48]' that is a derived union with these attributes subsetting it: <ul style="list-style-type: none"> • SeatedPassengers [0..36] • StandingPassengers [0..10] • WheelchairPassengers [0..2]
Owned	Click on the drop-down arrow and select True or False to indicate whether the role is owned by the opposite Class rather than the Association. Selecting True adds a 'dot' to the appropriate end of the connector ().

Notes

- Source role details are displayed at the start end of a connector on the diagram; if you have drawn the connector the wrong way, correct it by right-clicking on the connector and selecting the 'Reverse Direction' option
- Target role details are displayed at the terminating end of a connector on the diagram

Connector Constraints

A UML connector can have associated constraints placed on it. Constraints provide information on the rules and conditions under which a relationship operates. For example, it might be a pre-condition that a customer is of a certain type before an Association connector to an Account is allowed.

You can add the constraints using the 'Constraints' tab in either the connector 'Properties' dialog or the Properties window; the fields are the same.

Access

Ribbon	Start > Application > Design > Properties > click on connector in a diagram > Constraints (Properties window) Click on connector in a diagram Design > Element > Editors > Element > Properties Dialog (connector 'Properties' dialog)
Keyboard Shortcuts	Ctrl+2 > click on connector in a diagram > Constraints (Properties window)
Context Menu	Right-click on Connector Properties > Constraints (connector 'Properties' dialog)
Other	Double-click on Connector > Constraints (connector 'Properties' dialog)

Set constraints on a connector

Option	Action
Constraint	Type the name of the constraint.
Type	Click on the drop-down arrow and select the appropriate type of the constraint (such as Pre-condition).
<notes>	Type any explanatory notes you might require on the constraint. You can insert line breaks in the text by pressing Ctrl+Enter.
Save	Click on this button to save the constraint definition. The constraint is added to the 'Defined Constraints' list.
New	Click on this button to clear the dialog fields so that you can enter details of a new constraint.
Defined Constraints	Displays a list of the constraints defined for this connector.
Delete	Click on this button to delete a constraint you have selected in the 'Defined Constraints' list. The constraint is immediately removed from the list.

Notes

- Constraints on an Association connector can be added to further refine the model; constraints detail the business and operational rules for the model

Binding

Template Binding connectors, and also Generalize, Realize and Associate connectors, have a 'Binding' tab on their 'Properties' dialog and in the Properties window. You use this tab to define binding expressions and parameter substitutions for the connector.

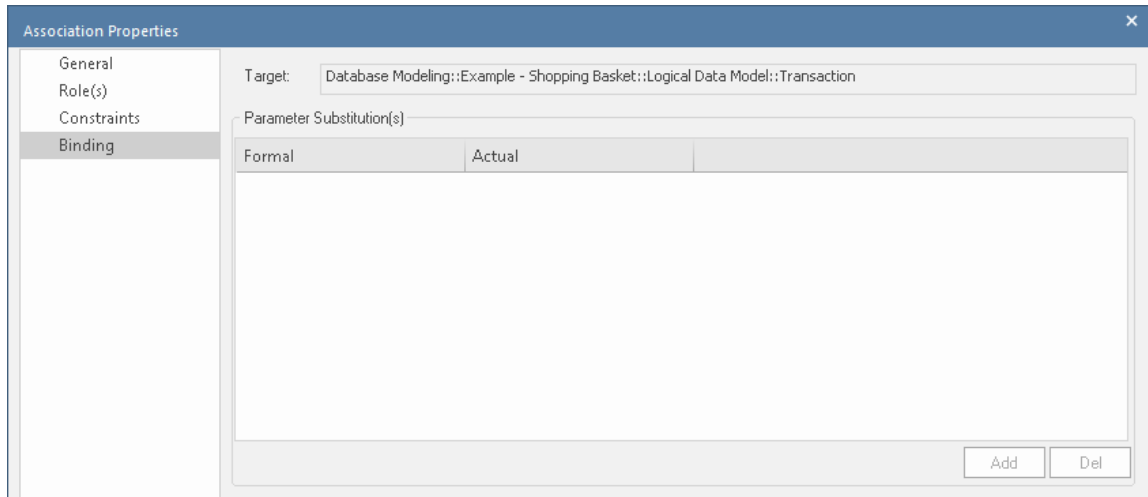

Properties Window for Attributes

The docked Properties window provides a convenient and immediate way to view and edit common properties of modeling objects, including attributes. When you click on an attribute in the Browser window or a diagram, the Properties window immediately shows the attribute's properties on the 'Attribute' tab.

You can also swiftly display the properties of other types of object, such as elements, connectors and diagrams on the same window without having to open and close separate dialogs.

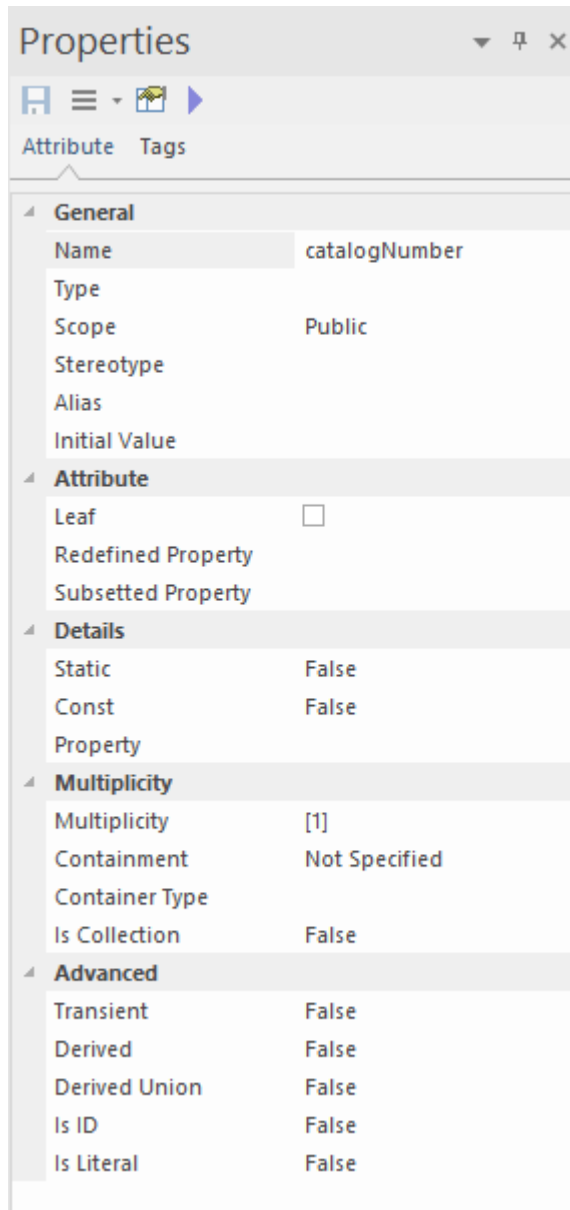

Access

Ribbon	After selecting the Properties window using one of these methods, click on the first required attribute. Start > Application > Design > Properties or Design > Element > Editors > Attributes: right-click on an attribute Properties
--------	---

	<p>window or</p> <p>Explore > Portals > Windows > Properties > Properties</p>
Keyboard Shortcuts	Ctrl+2 or Ctrl+Enter, then click on the required attribute

General Settings

Field	Description
Name	Displays the name of the selected attribute. If necessary (for example, if it is a place-holder name) overwrite this name with a new name.
Type	Displays the assigned type of the attribute. If necessary, click on the drop-down arrow and select either a different type, or the 'Select Type' option to display the 'Select Type' browser to locate a classifier element as the type.
Stereotype	<p>If the attribute has a stereotype, this field displays the stereotype name. To add or change the stereotype, click on the browse icon and use the 'Stereotype for <attributename>' dialog to select the stereotype from the appropriate profile.</p> <p>You can select multiple stereotypes; on the dialog, they are listed on separate lines of the 'Stereotype' field</p>
Scope	Displays the scope of the attribute. If you need to change the scope, click on the drop-down arrow at the right of the field and select the appropriate value.
Alias	Displays any alternative name or reference for the attribute. If you need to add or change the alias, overwrite the field.
Initial Value	Displays the initial value of the attribute. If you need to add or change the value, overwrite the field.

Advanced Settings

Field	Description
Containment	Displays the type of containment specified for the attribute. If you need to change this setting, click on the drop-down arrow at the right of the field and select the appropriate value.
Static	The flag indicating if the attribute is a static member; to change this flag, type 'F' or 'T' in the field, as appropriate.
Property	<p>If the attribute has automatic property creation, click on the  button to define how it should be implemented for the programming language you are modeling for. The 'Create Property Implementation' dialog displays.</p>

Const	The flag indicating if this attribute is constant (read-only, blocked from change). To change this flag, type 'F' or 'T' in the field, as appropriate.
Is Literal	(For Enumeration elements.) The flag indicating if the attribute is an enumeration literal. To change this flag, type 'F' or 'T' in the field, as appropriate.
Transient	(For Java code.) The flag indicating whether or not the attribute can change regardless of what the code is performing. To change this flag, type 'F' or 'T' in the field, as appropriate.
Derived	The flag indicating whether the attribute is derived from one or more other attributes; for example, full name can be derived from the last name and first name attributes. To change this flag, type 'F' or 'T' in the field, as appropriate.
Derived Union	<p>The flag indicating if the attribute is a derived union (that is, derived from a strict union of all properties that are constrained to subset it). To change this flag, type 'F' or 'T' in the field, as appropriate.</p> <p>As an example, you might set this field to True for a Class 'Schoolbus' with an attribute 'Passengers [0..48]' that is a derived union with these attributes subsetting it:</p> <ul style="list-style-type: none"> • SeatedPassengers [0..36] • StandingPassengers [0..10] • WheelchairPassengers [0..2]
Is ID	The flag indicating whether the attribute can be used to uniquely identify an instance of the containing Class. To change this flag, type 'F' or 'T' in the field, as appropriate.
Multiplicity	<p>Click on the  button to display the 'Multiplicity' dialog, and define the multiplicity of the attribute.</p> <ul style="list-style-type: none"> • Lower Bound - Type the lower limit to the number of attributes that must be in the collection • Upper bound - Type the upper limit to the number of attributes allowed in the collection • Allow Duplicates - Select the checkbox to indicate that duplicate values are allowed; this field maps to the UML property isUnique, with a value False • Multiplicity is Ordered - Select the checkbox to indicate that the collection is ordered • OK - Click on this button to save the information and close the dialog
Is Collection	The flag indicating whether the attribute is a collection (array), so that it can contain multiple concurrent values, or a single value. To change this flag, type 'F' or 'T' in the field, as appropriate.
Container Type	If the attribute is a collection, type the name of the container type for the collection.

Notes

- The 'Properties dialog' for attributes also has a 'Redefines' tab, which lists any Redefined Property or Subsetted Property added to the selected attribute; click on the appropriate Add button to add or change the properties in the

lists, selecting each property from the 'Select Property' dialog

- The dialog also has a 'Constraints' tab on which you define the constraints on the attribute

Create Properties

You can configure Enterprise Architect to automatically create properties in the modeled code in any of the programming languages that the system supports. You control property creation from the Properties window for Attributes. Each language has slightly different syntax and generates slightly different results:

- Java and C++ generate get and set functions
- C# and VB.Net create property functions
- Delphi creates get and set functions as well as a specialized Delphi property Tagged Value

Note that the attribute must have a defined Type in order to create properties.

Access

Ribbon	Design > Element > Editors > Properties
Context Menu	Right-click element in Browser window or diagram Properties Properties
Keyboard Shortcuts	Ctrl+2

Configure Properties for an Attribute

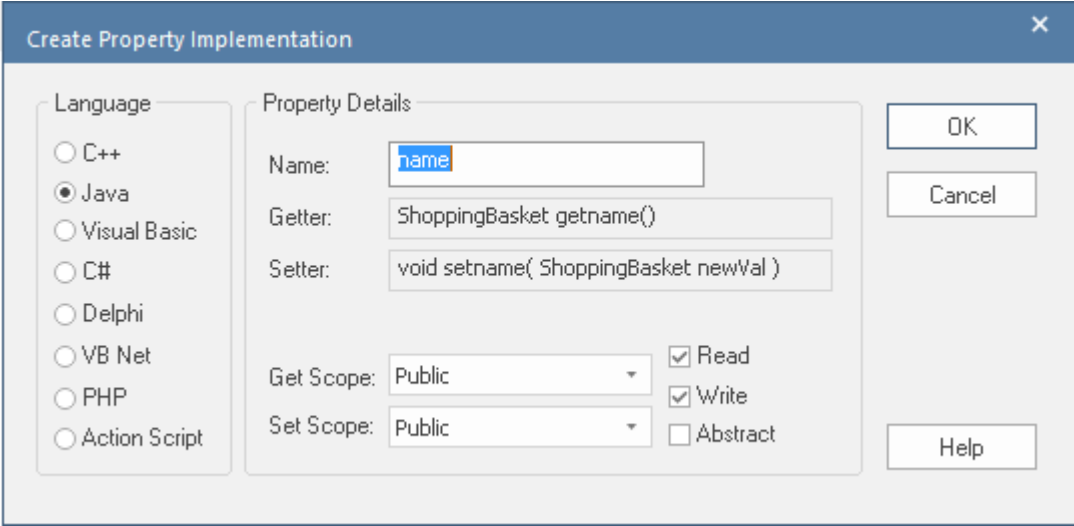
Step	Action
1	In the Browser window or a diagram, click on the attribute for which to configure property creation. The attribute becomes the focus of the Properties window.
2	Expand the 'Details' section of the 'Attribute' tab, and click on the 'Property' field and on the  button. The 'Create Property Implementation' dialog displays.
	
3	The 'Language' panel defaults to the radio button for the language defined in the Class properties;

	<p>however, you can click on any other radio button to select another language for which to configure property creation.</p> <p>Each language enables its own combination of fields in the 'Property Details' panel.</p>
4	<p>The 'Name' field defaults to the name of the attribute. If necessary, you can overtype this with a different name.</p> <p>Select the checkboxes or values from drop-down lists for these fields as required (and if available) to define the property for the selected programming language:</p> <ul style="list-style-type: none">• By Ref• Stereotype• Get Scope• Set Scope• Published• Read• Write• Abstract
5	<p>Click on the OK button</p> <p>The system generates the required operations and properties to comply with the selected language.</p>

Notes

- Get and Set functions have the stereotypes «property get» and «property set», making it easy to recognize property functions in the operations compartment of the element on a diagram; you can also hide these specialized functions on a specific diagram, by deselecting the 'Property Methods' checkbox on the 'Features' page of the 'Properties' dialog for the diagram, which then makes it easier to view the Classes uncluttered by many get and set methods
- For the Delphi programming language, enable the Tagged Values compartment to see the generated property Tagged Value

Attribute Constraints

Attributes can have constraints associated with them, which typically indicate such things as maximum value, minimum value and length of field. You define these constraints on the Properties window for attributes.

Access

Click on the required attribute in a diagram or the Browser window, and use one of these methods to display the attribute 'Constraints' tab.

Ribbon	Design > Element > Properties > General > Properties Dialog > Constraints Start > All Windows > Properties > General > Properties Dialog > Constraints
Context Menu	Right-click attribute in diagram or Browser window Properties Properties > Constraints

Define Constraints

Option	Action
Constraint	Type in the name or action of the constraint.
Type	Click on the drop-down arrow and select the appropriate constraint type.
(Notes)	Type in any comments or notes concerning the constraint.
New	Click on this button to clear any displayed data from the constraint fields, so that you can define a new constraint.
Save	Click on this button to save any new data in the fields, and to clear the fields in preparation for defining another constraint. The saved constraint is added to the top of list in the second 'Constraint' field.
Constraint	Lists the existing constraints on the attribute. If you click on an entry in the list, the constraint details display in the tab fields.
Delete	Click on a constraint in the list and click on this button to immediately remove the constraint from the attribute.

Properties Window for Operations

The docked Properties window provides a convenient and immediate way to view and edit common properties of modeling objects, including operations. When you click on an operation in the Browser window or a diagram, the Properties window immediately shows the operation's properties on the 'Operation' tab. You can also swiftly display the properties of other types of object such as elements, connectors and diagrams on the same window without having to open and close separate dialogs.

The Properties window for operations also has a 'Tags' tab to create and display Tagged Values.

On the Properties window and the Properties dialog for an operation, the 'Operation' tabs have the same fields.

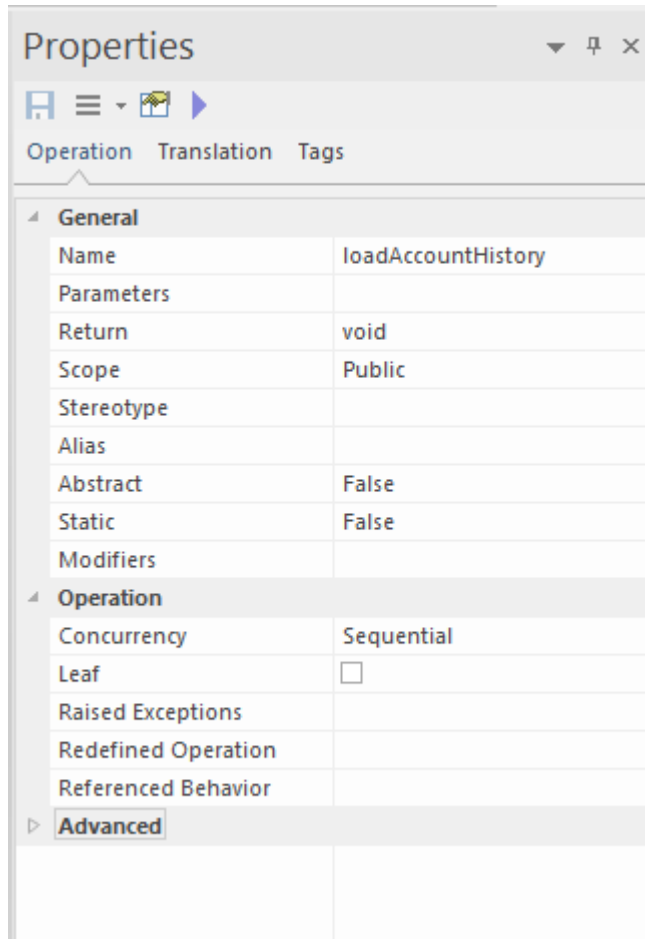



Access

After selecting the Properties window using one of these methods, click on the first required operation.

Ribbon	Start > Application > Design > Common > Properties Design > Element > Editors > Element > Properties Explore > Portals > Windows > Properties > Properties
Keyboard Shortcuts	Select operation in the Browser Window or a diagram. Ctrl+2 or Ctrl+Enter

Properties

Property	Description
Name	Displays the name that has been allocated to the operation. If you want to change this, overwrite the text in the field.
Parameters	Lists the parameters that have been defined for this operation on the 'Parameters' tab of the operation 'Properties' dialog. You can also type in simple parameter definitions in UML Test input; for example: age:int, max:int
Return	Displays the return type of the operation (defaulting to 'void'). To change this, overwrite the field or click on the drop-down arrow and click on: <ul style="list-style-type: none"> The required data type returned by the operation, as defined by the code language (data type) or '<none>' for no type (or you can type in a value manually if you prefer), or 'Select Type' and browse for the appropriate operation classifier (you can add a new one if there are no classifiers that suit) To add new code language data types that can be displayed in this list, see the <i>Data Types</i> topic.
Scope	Displays the scope currently set for the operation. If it is necessary to change this, click on the drop-down arrow and select one of: <ul style="list-style-type: none"> Public Protected Private Package
Stereotype	(Optional) Displays any stereotypes that have been defined for the operation; if you want to add others, either: <ul style="list-style-type: none"> Type a stereotype name, or Click on the  button and select the stereotype from the 'Stereotypes for <object name>' dialog
Alias	(Optional) Displays any alias that has been defined as an alternative name or reference for the operation. If necessary, overwrite this with a different alias.
Concurrency	Displays the concurrency of the operation - Sequential, Guarded or Synchronous. If necessary, click on the drop-down arrow and select a different setting.
Abstract	The flag indicating if this operation is an abstract function. If it is necessary to change this, type T or F in the field to change it to True or False, as appropriate.
Static	The flag indicating if this operation is a static member. If it is necessary to change this, type T or F in the field to change it to True or False, as appropriate.
Modifiers	Click on the  button to display the 'Select Modifiers' dialog, and select the appropriate checkboxes:

	<ul style="list-style-type: none">• 'Pure' - indicates that the method statement is pure virtual syntax. For example: virtual void myFunction() = 0;• 'Const' - indicates that the return type of the method is constant• 'Is Query' - indicates that the method does not modify the object• 'Return Array' - indicates that the method's returned value is in the form of an array• 'Synchronized' - for Java, sets a code engineering flag that relates to multi threading
Concurrency	Reflects the setting of the earlier field.
Leaf	Indicates whether the operation is a Leaf and cannot be overwritten.
Raised Exceptions	You can create code in your application to check for an exception and, if one occurs, to switch to the code defined by a Classifier element that you identify in this field, or through the operation 'Properties' dialog.
Redefined Operation	If the parent element of the selected operation is the source element for a Generalize connector, you can configure the operation to redefine an operation in the target element. You can identify the target operation (and its parent element) in this field or in the operation 'Properties' dialog.
native	The flag indicating if this operation is a native operation. If it is necessary to change this, type T or F in the field to change it to True or False, as appropriate.

User Button

For models with user security enabled, the name of the currently logged in user will display in the ribbon header in the top right of the screen. If you click on the user's name, a drop down menu displays providing a set of user options.

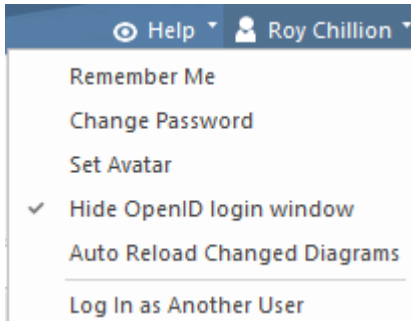

User Button Menu

Menu Item	Description
Remember Me	<p>Select this option to securely store the current user's login credentials for the current model. The next time the user attempts to open the model, the stored credentials will be used instead of prompting the user for their credentials.</p> <p>Note:</p> <ul style="list-style-type: none"> This requires the option 'Allow 'Remember Me"' to be enabled on the 'Security Users' dialog The credentials are stored on the current computer and can not be transferred between computers, users or models
Change Password	Change the password for the logged in user.
Set Avatar	Set an image to be used as an avatar for the logged in user.
Hide OpenID login window	Displays (unselected) or hides (selected) the 'OpenID login' dialog when you open the project. The option also resets the 'Don't show this window again' checkbox on the 'OpenID login' dialog.
Auto Reload Changed Diagrams	Automatically reloads open diagrams that have been saved by other users within the last 60 seconds.

Log In as Anot her User	Display the Login panel, on which you log into the model as another user.
-------------------------------------	---

The Notes Window

Notes are textual descriptions that can be added to an element, diagram, connector, feature or assigned item (such as Tests, Maintenance items, or allocated resources) in Enterprise Architect. They provide valuable information that describes the entity being modeled. Many newcomers to modeling are not aware that these textual descriptions are core to many of the modeling languages, including UML, BPMN and SysML; without them the model would be hard to understand and remain opaque. A well-formed note is unambiguous and doesn't contain redundant information that has been entered in other properties of the entity.

Using the Notes window

You can create and view notes in the Notes Window, which can be docked anywhere in the application, or through the 'Properties' dialog or editing dialog for a modeling object or feature. The notes can be formatted using the Notes Toolbar, conveniently located above the notes text field. This formatting is carried through to documentation generated from the model, and includes markup such as italics, bolding, bullets and hyperlinks. You can also reference Glossary Terms and model elements from the notes text. There are convenient keyboard shortcuts available for quickly editing the text.

Many experienced modelers have the Notes window docked in the workspace, and when they select an entity in a diagram, the Browser window or another window, that object immediately becomes the focus of the window and they can view, create or edit the notes. Conversely, if you have limited screen space and do not want to keep the Notes window open all the time, you can display the Quicknotes window, which is a simpler version of the Notes window without the toolbar. You can still format the text using context menu options. The Quicknotes window closes when you click outside it.

There are two variants of the Notes window or field:

- For standard modeling objects such as elements, connectors, diagrams, attributes and operations, where the text field contains only the text you type into it and the number of characters of text currently contained in the field is displayed in the left-hand end of the Status bar

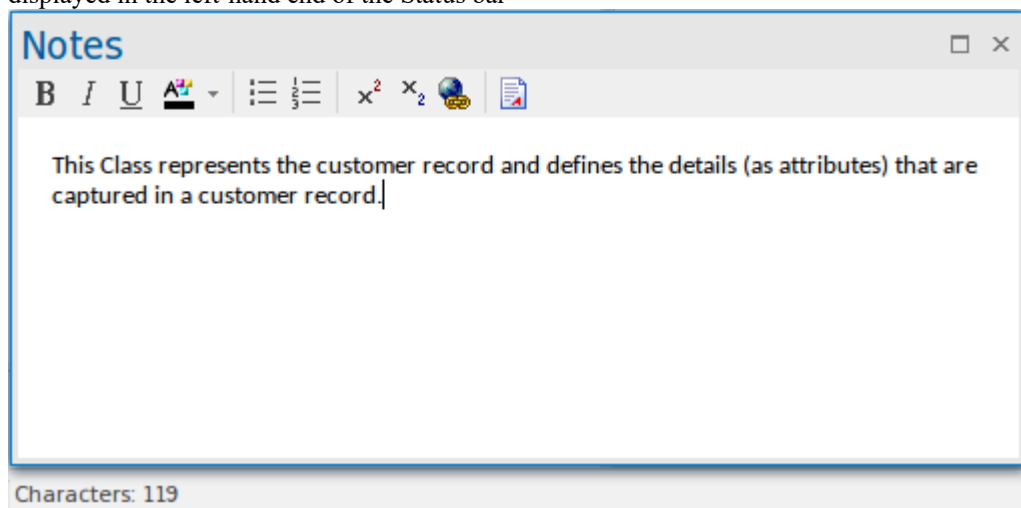

- For assigned items such as Tests, Maintenance Items, Project items and allocated resources, where the text field contains automatic headings - 'Description' and 'History' - that cannot be deleted, and that reflect the text typed into the corresponding tabs in the item's editing dialog; for Test items, the headings are 'Description', 'Input', 'Acceptance Criteria' and 'Results'

This variant does not show a character count in the Status bar

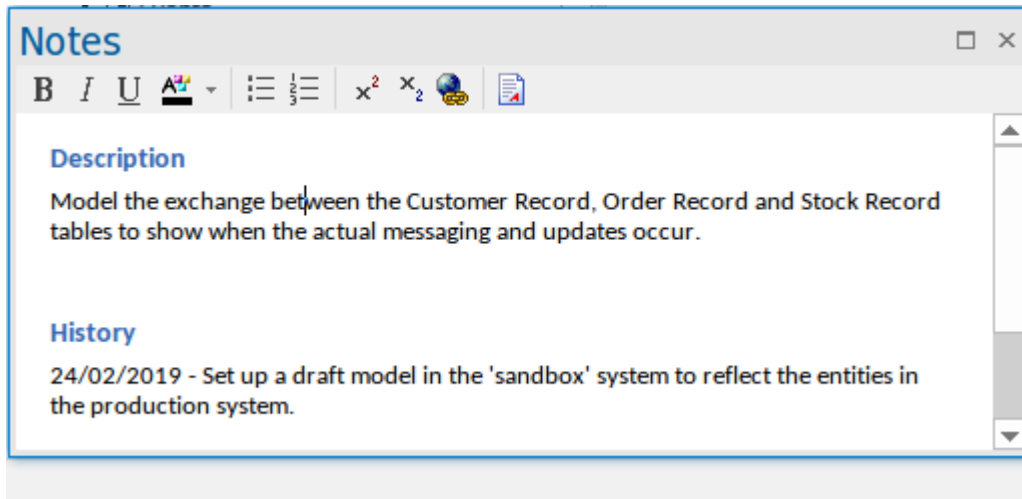

This difference is reflected in the Quicknotes window as well, where Ctrl+Spacebar displays the general Notes text or, for an assigned item, the 'Description' text.

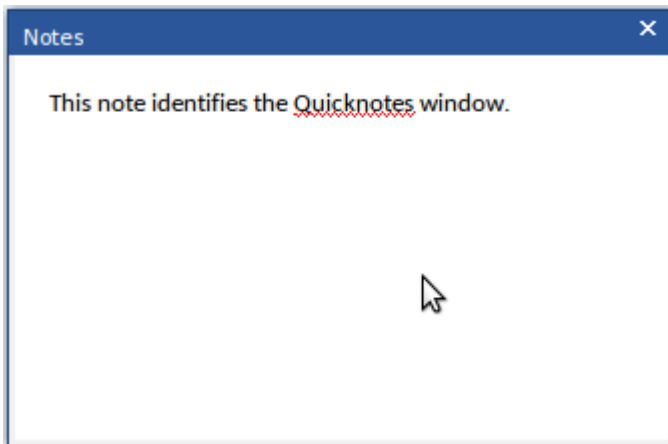

For an assigned item, Shift+Space displays the 'Results' or 'History' text.

When text translation is enabled and configured on the 'Translations' page of the 'Manage Model Options' dialog, the Notes window has a 'Local' tab (to display Notes text in the original language) and a 'Translation' tab in which you select to translate and display the same Notes text in the selected language. See the *Text Translation* Help topic.

If you are working in a Cloud-connected model and have also connected to an external data source, when you select an external data item a separate version of the Notes window displays to show the external item Notes text. See the *External Item Details* Help topic.

If the text in the Notes window or 'Notes' fields does not render as well as you would like, you can change the font using the 'Note Editor Font' option on the 'Application Look' dialog. You can also change the zoom level applied to all notes text, using the 'Default Note Zoom' field; this field is initially set to 110%. See the *Visual Styles* Help topic.

Access

Ribbon	Start > All Windows > Design > Create > Notes Design > Element > Properties > General > Notes Start > All Windows > Properties > General > Notes
Context Menu	Right-click on model element Properties Notes

Keyboard Shortcuts	<p>Ctrl+3</p> <p>Ctrl+Space (Quicknotes)</p> <p>Shift+Space (Quicknotes History)</p> <p>Alt+1 Create Notes</p> <p>Alt+2 General Notes</p>
--------------------	---

Notes Context Menu options

Option	Action
Create Glossary Definition	<p>Click on this option to create a Project Glossary definition, with the Glossary term taken from the selected 'Notes' text.</p> <p>To create the Glossary entry:</p> <ol style="list-style-type: none"> 1. If suitable Notes text is available, highlight the text to use as the Glossary definition and press Ctrl+C to copy it. 2. Highlight the text to use as the Glossary term, right-click on it and select the menu option; the 'Glossary Detail' dialog displays, with the selected text in the 'Term' field. 3. If you have copied some definition text, paste it into the 'Meaning' field; otherwise type a suitable definition of the term in this field. 4. In the 'Type' field, select the appropriate term type. 5. Click on the Apply button to save the new Glossary definition. <p>The term displays in the 'Notes' text as a Ctrl+click hyperlink, which displays the Glossary definition of the term in the 'Glossary Detail' dialog.</p> <p>Once you have created a Glossary definition, here or elsewhere in the model, you can add the Glossary term anywhere in the text of the Notes window (or 'Notes' field of a dialog) where, again, it becomes a Ctrl+click hyperlink to the definition. Either:</p> <ul style="list-style-type: none"> • Simply type the term in the text, or • If you are not certain of the term or have multiple definitions: <ol style="list-style-type: none"> 1. Move the cursor to the point in the text at which to insert the term. 2. Press Ctrl+Space; the Glossary Term Selection window displays. 3. Double-click on the term to insert it in the text.
Create New Element from Selection	<p>Click on this option to create a new element in the model, the name of which is taken from the selected Notes text.</p> <ol style="list-style-type: none"> 1. Click on the option. 2. The 'New Element' dialog displays, with the 'Name' field pre-filled with the selected text. 3. Set the element type and other options as necessary, then click on the Create button. (You can also select an option on the dialog to add the element to the diagram.) 4. The system creates the element, adds it to the model (and diagram) and creates a hyperlink to it from the selected Notes text.
Create Element on Diagram	<p>Click on this option to create a new element in the model, and explicitly in the diagram also, with its name taken from the selected Notes text. This option does not</p>

	<p>make the selected text a hyperlink to the element.</p> <ol style="list-style-type: none"> 1. Click on the option. 2. The 'Toolbox Shortcut' menu displays for the diagram type. If necessary, click on the 'Other' option and select from a different set of element types. 3. Click on the required element type and then click on the diagram. A new element is created at the cursor position, with the selected text as the element name.
Create Link to Existing Element	<p>Click on this option to create a hyperlink from the selected Notes text to an existing element in the model.</p> <ol style="list-style-type: none"> 1. Click on the option. 2. The 'Select Classifier' dialog displays. Locate and select the required element, and click on the OK button. 3. The selected Notes text becomes a hyperlink to the element. The target element name and Notes text remain unchanged and do not necessarily mirror each other.
Translate Mark for Translation	<p>If Automatic Translation is enabled, highlight a term or word then click on this option to identify a specific translation for this instance of the selected text. A prompt displays in which you specify which Glossary Category the translation for that term is defined in, within the Translation section of the Glossary Model.</p> <p>This is of particular value where the sequence of a string of words is important, such as a breadcrumb trail, menu path or ribbon path, especially where the same or related terms are used in different sequences of words. A free translation might re-organize the sequence of words, or combine words, making it hard to follow instructions or recognize the context. You would therefore make sure that the translation of this specific combination of words exactly matched what the reader is intended to see.</p>
Translate Do not Translate	<p>If Automatic Translation is enabled, highlight a term or word then click on this option to protect the selected instance of the text from the translation process. You might use this if a term has different meanings, some of which are appropriate for translation and some of which have a special application that should not be translated. For example, you might freely translate the words 'the wood' in the context of a material, but want to protect 'The Wood' as a reference to a location.</p>
Search for '<selected>'	<p>Click on this option to display a subset of the functions of the common Code Editor menu 'Search' option, to locate a text string outside the element.</p> <p>In a 'Notes' field (not in the Notes window) you can perform a search of the text for a text string:</p> <ul style="list-style-type: none"> • Press Ctrl+F and specify the text string and the direction of search • Press F3 to locate more instances of the word in a forward search, or Ctrl+F3 in a backwards search
Undo Cut Copy Paste Delete Select All	<p>These six options provide simple functions for editing the Notes text.</p>
Print	<p>Click on this option to send the Notes text directly to the configured printer.</p>

Thesaurus	<p>Highlight a word in the Notes text and click on this option to display the 'Thesaurus' dialog, which shows the meaning of the selected word, its synonyms and - if you select the 'Antonyms' checkbox - its antonyms. The antonyms are listed at the bottom of the Categories panel.</p> <p>If you want to replace the selected word with one of its synonyms, click on the synonym and on the OK button.</p>
Highlight Glossary Terms	<p>Select this option to reveal underlines and other markers on text strings that have a glossary definition assigned to them. Select again to clear the 'selected' arrow, to hide the glossary markers in the text.</p> <p>This option is available in the 'Notes' and 'Description' fields, Discuss & Review window tabs, Chat & Mail window tabs, Scenario Editor, Specification Manager and 'Mail Message' dialog. This is a global option - selecting it or clearing it for one screen will affect all the other screens.</p>

Keyboard Options For Notes

Option	Description
Switch text orientation	<p>Hold Ctrl, press Shift</p> <p>Description: On a line of text, right-justifies or left-justifies the paragraph in which that line occurs.</p> <p>Use the keys on the left of the alphanumeric keyboard to left-justify the text; use the keys on the right of the keyboard to right-justify the text.</p>
Insert Date and Time	<p>F5</p> <p>Description: Inserts the current date and time at the cursor position, in the format: DD/MM/YYYY HH:MM:SS AM (or PM)</p> <p>For example: 22/12/2016 3:39:50 PM</p>
Spell check Notes text	<p>F7</p> <p>Description: Performs a simple spell check on the Notes text.</p>
Undo changes	<p>Ctrl+Z</p> <p>Description: Reverses the last change made to the Notes text.</p>
Redo changes	<p>Ctrl+Y or Ctrl+Shift+Z</p> <p>Description: Re-applies the last reversed change to the Notes text.</p>
Copy	<p>Ctrl+C</p> <p>Description: Copies a highlighted Notes text string to the Enterprise Architect buffer.</p>
Paste	<p>Ctrl+V</p> <p>Description: Pastes a copied or cut text string from the Enterprise Architect buffer into the Notes text.</p>

Cut	Ctrl+X Description: Removes a highlighted Notes text string and places it in the Enterprise Architect buffer.
-----	--

Notes Toolbar

Although it is not an independent toolbar that you can pin to the screen top or sides, or float in your work area, the Notes toolbar appears in many places across Enterprise Architect in the 'Notes', 'Description' and 'History' fields in, for example, the:

- Element and connector 'Properties' dialogs
- Feature 'Properties' dialog
- Diagram 'Properties' dialog
- 'Hyperlink Details' dialog
- Test Cases window descriptions
- Notes window
- 'Glossary Detail' dialog
- Responsibility window



Options

The options of this toolbar operate on selected text and any new text continuing from the formatting. The options (with some keyboard shortcuts) are, from left to right:

- Make text bold (Ctrl+B)
- Make text italic (Ctrl+I)
- Underline text (Ctrl+U)
- Change the font color of the text
- Insert list bullet points (Ctrl+.) (full stop)
- Insert list numbering (Ctrl+0)
- Make text superscript
- Make text subscript
- Insert a hyperlink - this displays the 'Hyperlink Details' dialog, on which you specify the type of hyperlink and type in or browse for the location of the target of the hyperlink
- Create a new Linked Document for the element, or edit an existing one

Notes

- If the toolbar is displayed but grayed out, the text field is read-only and cannot be edited; other long text fields in Enterprise Architect might not have the toolbar, in which case the Notes facility is not available for those fields
- You can create a Project Glossary term and definition from text in any field that has the Notes toolbar

Text Translation

The translation facilities operate primarily on the text entered into the Notes window, so this is the principal interface between users and the translations. When the model administrator enables and configures translations on the 'Translations' page of the 'Manage Model Options' dialog, the Notes window has a 'Local' tab that displays note text in the natural language for the model, and the 'Translation' tab in which you select to translate and display the same note text in one of the selected languages.

Through the Notes window you can use the Enterprise Architect text translation feature to:

- Perform a manual translation of the notes text displayed in the 'Local' tab, by typing or pasting the translation into the 'Translation' tab; available in all editions of Enterprise Architect
- Automatically translate the Notes text into one of the selected languages (if using an internet translator application); available in any Cloud-connected repository
- Block automatic translation of a specific instance of text, or select an instance of text to be translated according to a category in the Glossary Model (on the 'Local' tab)
- Force a translation if the translator is not set to operate automatically
- Toggle automatic translation if you are editing either the original text or a Translated text and do not want the original text to be translated
- Reset the 'difference' flag on the 'Translation' tab, when the flag indicates that either the translation or the original text has been changed since the note text was translated

Manual Translation

In preparation for performing a manual translation, you first enable the Translation facilities and - if you have the Corporate or higher edition - specifically select the option of performing manual translations, on the 'Translations' page of the 'Manage Model Options' dialog. You also select the source and target languages; you can select more than one target language.

To enter a manual translation of the notes for a selected object, display the 'Translation' tab of the Notes window (Ctrl+3 > Translation), click on the drop-down arrow in the 'Language' field and select the language in which to translate the notes shown in the 'Local' tab.



Now you either manually type or paste a translation of that text into the text field of the Notes window, in the selected language.

If you want to create translations of the Notes text in more than one language, simply select each language in the 'Language' field in turn and enter the translation in that language. The translations are held in the model as different pages, each displayed when the appropriate language is selected.

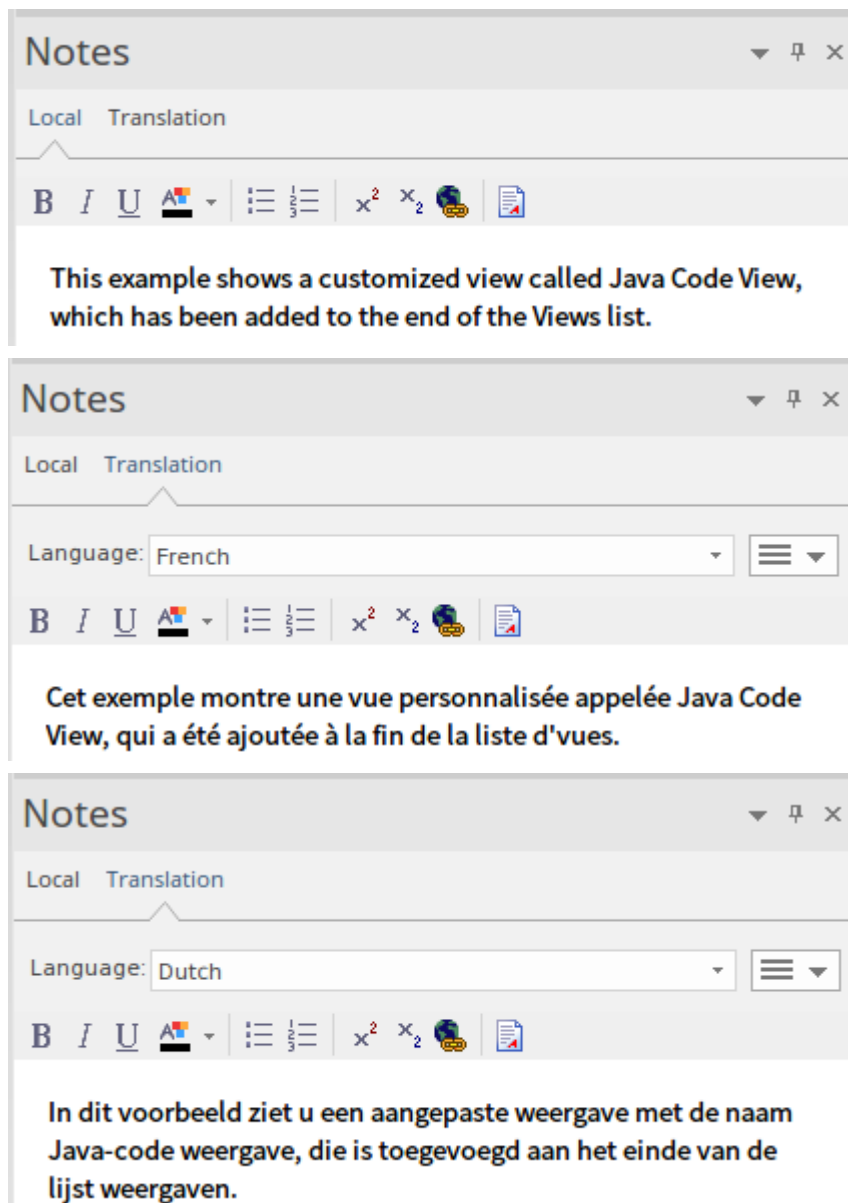

You can edit the translated text at any time. Note that if you do edit the translation, or the text in the 'Local' tab - in the source language - is changed (that is, the modified date/time on the original text is later than on the translation text) an asterisk displays on the 'Translation' tab name to indicate that the translation(s) might not match the original text. The asterisk is removed when you select the 'Verify Translation' Hamburger option on the 'Translation' tab.

Note that you can also manually translate the object name and alias into any or all of the enabled languages, using the Properties window for the object.

Automatic Translation

In preparation for performing automatic translations, you first:

- Install and set up the Integration Plug-in for Google or Microsoft, or a customized Plug-in you have created for any other translator facility you want to use
- Enable the Translation facilities on the 'Translations' page of the 'Manage Model Options' dialog, register the translator and select the source and target languages; you can select more than one target language
- Prepare the Translation section of the Glossary Model to block the translation of specific terms (such as product names) or to provide your preferred translations of certain words either wherever they are used or when they are

used in particular contexts, such as in menu paths

You can select the 'Auto translate notes' option on the 'Translations' page to perform translations automatically as soon as you open the 'Translation' tab of the Notes window, or as soon as you change the language into which to translate the text, in the 'Language' drop-down list on that tab.

If you do not have the 'Auto translate notes' option selected, the Notes text is not automatically translated until you select the 'Force Translate' option from the Hamburger menu icon on the 'Translation' tab. This translates the text just for the current object in the currently selected language.

When an automatic translation is initiated, the system first checks the Translation elements in the Glossary Model and, where appropriate, applies the defined translation to the flagged words in the text. You flag these words and any that should not be translated at all using the context menu options in the 'Local' tab of the Notes window; see the *Notes* Help topic. The system then protects these words from translation, and allows free translation of the rest of the text.

Modify Automatic Translation

Text in the 'Translation' tab is laid out in the same format as the original text. Different languages have different structures, and the format or emphasis of text in one language might not suit another language. The translation itself might also not quite convey the context of the original language. In these situations, you can manually edit the translation to better represent your purpose.

As you do this, the 'Translation' tab name displays an asterisk to indicate that the content of the tab has been changed after the text was translated. The asterisk also displays if you edit the original text without retranslating the text. You can clear the asterisk by clicking on the 'Hamburger' icon on the 'Translation' tab and selecting the 'Verify Translation' option to indicate that the translation is acceptable.

To protect the changes you make in the translated text in a language, further automatic translation of that text in that language is blocked. To revert to the literal translation of the local text, click on the 'Hamburger' icon and select the 'Force Translation' or 'Auto Translate' option.

The Focus Window

The Focus window is a valuable tool for locating and examining items of importance from anywhere in the overall model. For example, you might want to identify and locate items having a particular group of characteristics, which are defined in a Model View. Or you might need to locate particular types of item that are currently active, or diagrams and windows that you personally have been working on recently. The Focus window provides several means of locating such items.

Access

Ribbon	Start > Application > Design > Focus
Keyboard Shortcuts	Alt+1 Focus

Focus Window Facilities

The Focus window has four tabs, each providing a means of defining, locating and accessing the particular items you want to review in the model.

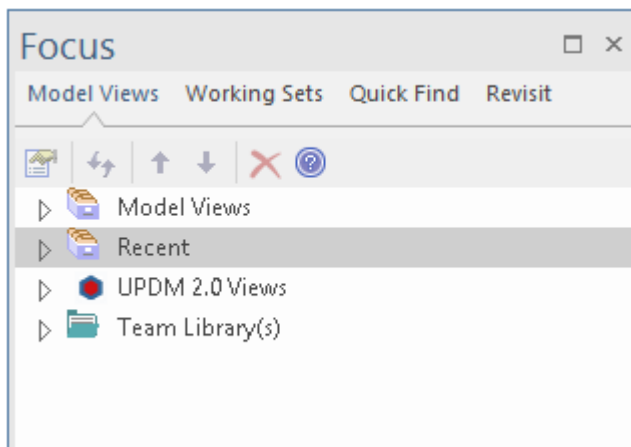

Tab	Description
Model Views	Provides access to the Model Views facilities.
Working Sets	Provides a list of the currently-defined Working Sets, each of which can be expanded to show the diagrams and facilities opened by the set.
Quick Find	A simple search for either elements or diagrams that have a specific text string in their names or Aliases.
Revisit	Provides lists of the Enterprise Architect diagrams, documents, windows and files that you have opened in the last seven days.

Model Views

The 'Model Views' tab helps you to capture information on the objects in your model from different aspects that you define yourself, helping you to encapsulate your model under the areas you are interested in. You can define a number of types of view based on searches or objects that you have placed into a collection, or you can collate diagrams into a slide show. You can also import views from, or export views to, other models. The Model Views window contains a 'Recent' folder, which keeps track of the elements, diagrams, documents, discussions reviews and maintenance (Construct) items you have recently been working on.

Model Views are not filtered by Perspective, so you will see all Views defined for your model at any time.



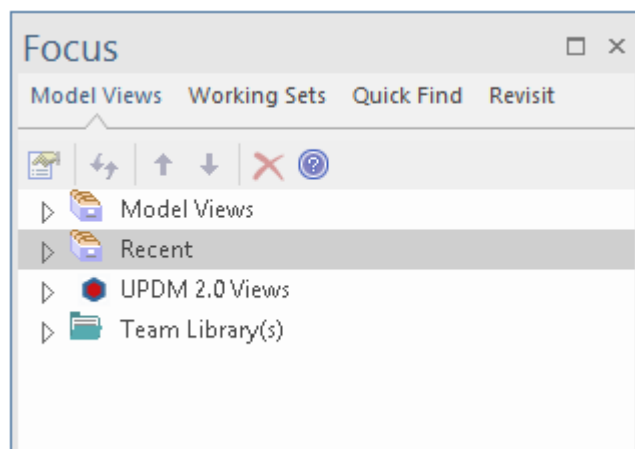

Access

Ribbon	Start > All Windows > Design > Explore > Focus > Model Views
Keyboard Shortcuts	Alt+1 Focus > Model Views

Features



Feature	Detail
View Root Nodes	<p>There are two types of View root-node available:</p> <ul style="list-style-type: none"> Model Views - stored in the model and visible to all users; you can have many of these Technology-defined Views - read only; each View is added by, stored with and populated by the corresponding MDG Technology <p>Additionally, there is a Library folder that contains current correspondence from the Library concerning items that are held in any of the Views; this folder has a separate repository of postings for each Library server connection you access through the model. You can control how recent these postings must be, and how many are to be listed.</p> <p>When you open the Model Views for the first time on a project, a Model Views root section is added for you. This can not be deleted or renamed; however, you can create further Model View root nodes that you can modify and delete.</p>

<p>Subordinate Folders</p>	<p>Under a Model View root node you can create Views folders, Search folders, Slideshow folders and Favorites folders. The Search, Slideshow and Favorites folders are functional and cannot contain subordinate folders, so whilst you can create several Search, Slideshow or Favorites folders immediately under the Model View node you can group and better organize multiples of these folders under appropriately-named View folders.</p> <ul style="list-style-type: none"> • A Search View is a folder of elements or structures that you assemble by assigning a Model Search to the folder - when you double-click on or expand the folder, the search runs and refreshes the folder contents; you can also set a search to refresh at a defined interval, and to notify you if new results are found • A Slideshow folder contains links to diagrams, which you can display as a slide show with the diagrams being displayed in the sequence in which they are listed in the folder One folder represents one slide show - you can run the slide show automatically or manually; in either case the diagrams are closed after they have been displayed • A Favorites folder gives you easy access to commonly-used items in the Browser window; to create hyperlinks in a Favorites folder to the required items in the Browser window; drag items from the Browser window into the Favorites folder <p>You can also export all of the View folders containing Views from any root section as an XML file, and import a Views XML file as an additional, editable Model View root node.</p> <p>These are single-level items; if you drag a Package into the Favorites folder, you cannot expand that Package there. However, you can double-click on the Package in the Favorites folder to select and highlight it in the Browser window.</p> <p>To select specific items inside a Package, expand it in the Browser window and then drag the items into the Favorites folder.</p>
<p>Key to Model View Contents</p>	<p>Items on the Model View can be identified by their accompanying icons:</p> <ul style="list-style-type: none"> •  - A Model Views root node •  - A View Folder •  - A Favorites Folder •  - A Search Folder •  - A Slideshow Folder <p>MDG Technologies can define their own Model Views, in which case they will display their own technology-specific icon.</p>
<p>The Recent Folder</p>	<p>The 'Recent' folder provides links to searches that extract information on the current status of objects and items in the model. The searches are grouped to identify:</p> <ul style="list-style-type: none"> • Recently changed elements, diagrams and documents • Recent posts in discussions and formal reviews • Results of recently-run tests • Recently requested and implemented Change items • Recently reported and investigated Defects and Issues • Recently started, finished or active Tasks <p>See the Help topic <i>The Recent Folder</i>.</p>
<p>Accessing Operations</p>	<p>To perform operations on the Model View contents, you can use the item context menus.</p>

	Each level of the Model Views hierarchy has a slightly different context menu.
--	--

The Recent Folder

The 'Recent' folder provides links to searches that extract information on the current status of objects and items in the model. The searches are grouped to identify:

- Recently changed elements, diagrams and documents
- Recent posts in discussions and formal reviews
- Results of recently-run tests
- Recently requested and implemented Change items
- Recently reported and investigated Defects and Issues
- Recently started, finished or active Tasks

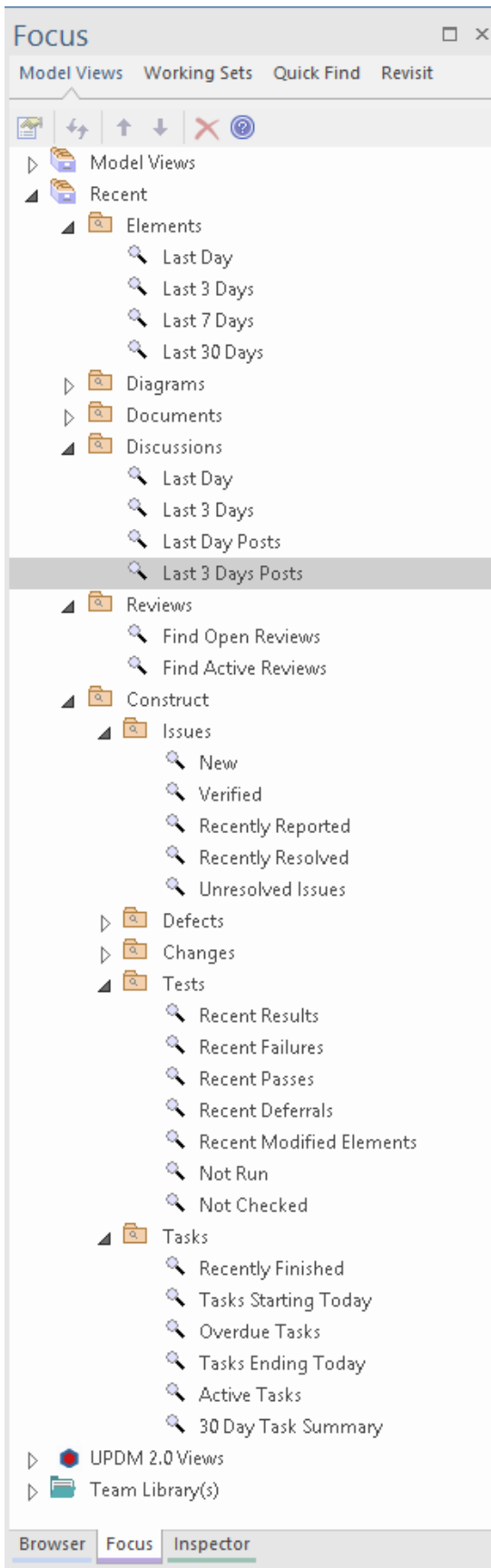

Access

Ribbon	Start > Application > Design > Focus > Model Views > Recent
Keyboard Shortcuts	Alt+1 > Focus > Model Views > Recent

Facilities

Object	Options
Elements	<p>These options execute searches across the model for elements that have been changed in the last:</p> <ul style="list-style-type: none"> • Day • Three days • Week • Thirty days
Diagrams	<p>These options execute searches across the model for diagrams that have been changed in the last:</p> <ul style="list-style-type: none"> • Day • Three days • Week • Thirty days
Documents	<p>These options execute searches across the model for documents that have been changed in the last:</p> <ul style="list-style-type: none"> • Day • Three days • Week • Thirty days
Discussions	<p>These options execute searches for elements with Discussions that have been opened or had posts within the last:</p> <ul style="list-style-type: none"> • Day • Three days
Reviews	<p>These options execute searches for Reviews that are:</p> <ul style="list-style-type: none"> • Currently open • Currently active
Construct	<p>This category is divided up into sets of options to search for elements with Change Management items - Issues, Defects, Changes and Tasks - having a specific status:</p> <ul style="list-style-type: none"> • New • Verified • Recently Reported • Recently Resolved • Unresolved Issues

	<p>Or, for Tasks:</p> <ul style="list-style-type: none">• Recently Finished• Starting Today• Overdue• Ending Today• Active• 30 Day Task Summary <p>The Construct category also has a set of options to search for elements with Test item results:</p> <ul style="list-style-type: none">• Recent Results• Recent Failures• Recent Passes• Recent Deferrals• Recent Modified Elements• Not Run• Not Checked
--	--

Model Views Context Menus

This section details the options available from the Model Views context menu, explaining the options provided at every level of the Model Views hierarchy.

Access

Ribbon	Start > All Windows > Design > Explore > Focus > Model Views : Right-click on object
--------	--

Options

The Model Views context menus display different options, depending on which level of the Model Views hierarchy you right-click on.

Menu Option	Action
Properties	<p>(Not for the initial Model Views or Technology-defined root nodes.)</p> <p>Display the appropriate 'Properties' dialog for the selected object.</p> <p>You can edit any of the properties, if required; changes to objects populated from the model are reflected in all other views (Properties window, diagrams, reports) of that object.</p> <p>The 'Properties' option for a Slideshow folder displays the 'Slideshow Properties' dialog, which enables you to automate the slide show and set the number of seconds for which each diagram is displayed. If you deselect the 'Enable' checkbox, you must press Spacebar to display each diagram.</p>
New Views Folder	<p>(Root node only)</p> <p>Display a prompt for the Views folder name and create the folder in the selected root node.</p>
New Model View	<p>(Root Nodes only)</p> <p>Add a new Model View root node; displays a prompt for the View name.</p>
Import Views From XML	<p>(Root node only)</p> <p>Prompt for the XML file location and create a new Model Views node to hold the imported Views.</p>
Export to XML (Views Only)	<p>(Root node only)</p> <p>Prompt for a file path and name, and copy all Views under the selected root node to an XML file at that location.</p>
Remove Model View	<p>(Not for the initial Model Views or Technology-defined root nodes)</p> <p>Display a prompt to delete the selected user-defined Model View and, if confirmed, delete the root node and all contents.</p>

New Search Folder	(View folder only) Display the 'Create New View' dialog (similar to the 'View Properties' dialog) for you to define the search that populates the View.
New Favorites Folder	(View folder only) Display the 'Create a new favorites based folder' dialog, which prompts for the folder name.
New Slideshow	(Model View, View folder only) Display the 'Create a new slideshow' dialog, in which you type the name of the slide show. You must use the 'Properties' dialog to define the properties of the slide show.
Open Search	(Search View only) Display the Model Search screen in the main work area, listing the full results of the search and giving access to all the facilities of the Model Search. Shortcut: Shift+Space
Refresh	(Search View only) Refresh the search and open the View to show the elements or documents retrieved by the search. Shortcut: Space
Double Click Opens Search	(Search View only) Enable you to perform the 'Open Search' function by double-clicking on the View. If you deselect this option, double-click refreshes the search and opens the View to show the elements retrieved by the search.
Remove Folder	(View folder only) Display a prompt to delete the selected Views folder and, if confirmed, delete the folder and all contents.
Remove View	Display a prompt to delete the selected Search View and, if confirmed, delete the View and all contents.
Remove Favorites	Display a prompt to delete the selected Favorites folder and, if confirmed, delete the folder and all contents.
Remove Slideshow	Display a prompt to confirm deletion of the selected slide show and, if confirmed, delete the slide show and all its diagrams.
Run Slideshow	Run the slide show in the Diagram View.
Run Slideshow Full Screen	Run the slide show in full screen mode, so that the slide show fills the whole screen.
Stop Slideshow	Cancel execution of the slide show running in the Diagram View. Shortcut: Esc
In Project Browser	(An element, diagram or Package object only) Highlight the selected item in the Browser window.

Find in all Diagrams	<p>(An element or child Package object only)</p> <p>Locate the selected object in any diagrams in which it has been used in the model, and either:</p> <ul style="list-style-type: none"> • Display the single diagram with the object highlighted or • List the several diagrams in which the object has been located
Remove Linked Item	<p>(An element, diagram or Package object only)</p> <p>Display a prompt to delete the selected object and, if confirmed, remove the object from the folder.</p> <p>This has no effect on the object in the Browser window or any diagrams.</p> <p>You would not delete an object in a View, as it is replaced the next time the View is refreshed.</p>
Edit Connections	<p>(On the Model Library folder) Displays the 'Team Documents Server Connections' dialog, on which you set up and manage the connections to Model Libraries in the current model and other models. Once a connection is defined, it is automatically established when you click on the model name.</p>
Open Model Library	<p>Opens the connection to the currently-selected Model Library and lists the folders containing the content.</p>
Find Document	<p>Locates the selected Model Library document in the Library window, and opens the document in the 'Team Document' tab of the main Enterprise Architect work area.</p>
Help	<p>(Root nodes only)</p> <p>Display Help on Model Views.</p>

Model Views Operations

From the Model Views window you can perform a number of operations to define the information you extract from the model and to further process that information, as described here.

Access

Ribbon	Start > All Windows > Design > Explore > Focus > Model Views
--------	--

Operations

Operation	Detail
Define Search View	<p>When you:</p> <ul style="list-style-type: none"> • Create a Search View, the 'Create New View' dialog displays • Display the Search View properties, the 'View Properties' dialog displays <p>These dialogs are identical.</p> <p>In the 'Name' field, type a name for the View.</p> <p>In the 'Search' field, either:</p> <ul style="list-style-type: none"> • Click on the drop-down arrow and select an existing search from the lists, or • Click on the  button and select to: <ul style="list-style-type: none"> - Create a SQL search on the 'Custom SQL Search' dialog or - Edit an existing search or define a new one using the 'Manage Searches' dialog, then close the dialog and select that search name in the second 'Search' field <p>A custom SQL search statement should return the GUID and type of the object found so that the system can search for the selected item in the Browser window. The SELECT statement is case-sensitive and should be typed as shown:</p> <pre>SELECT ea_guid AS CLASSGUID, Object_Type AS CLASSTYPE, Name FROM t_object</pre> <p>If required, in the ' Search Term' field type a specific value to search for.</p> <p>If you are working with the Corporate or extended versions of Enterprise Architect, and you want the search to run automatically and refresh the results, select the 'Refresh this search' checkbox. The 'Frequency' field has three sections, for hours, minutes and seconds; click on the appropriate section and use the up and down arrows at the end of the field to set the interval for refreshing the search results.</p> <p>You can also set the refresh to display a pop-up notification if the search results change. To do this, select the 'Notify me when new results found' checkbox.</p> <p>Click on the OK button; the Search View is created (or updated) in a collapsed state.</p> <p>When you expand the View, the search executes and populates the View.</p>
Move Objects Into Favorites	<p>Drag any required Package, diagram or element from the Browser window into the required Favorites folder.</p>

Move Objects Between Views	<p>Views and Favorites folders are fixed in the Views folder in which you create them, and you cannot move them.</p> <p>However, you can:</p> <ul style="list-style-type: none"> • Copy (by dragging) objects from any View into any Favorites folder, and • Move (by dragging) objects between any two Favorites folders
Use Objects From Model Views	<p>To make use of an element, diagram or Package held in any View or Favorites folder, click on the item and drag it into a diagram.</p> <p>The item behaves in the same way as if you dragged it from the Browser window.</p> <p>Also, when a Package has been identified as a Favorite in a Model View, you can double-click on it to select and highlight it in the Browser window.</p>
Create Documents containing Objects	<p>A very useful feature of the Model Views facility is the ability to drag separate items from the Views into an existing Linked Document.</p> <p>To do this you create your Linked Document, generate your Model View, and open the document and Model View as docked windows. You then drag the items - individually or as a multiple selection - from the View into the document, selecting one of two options:</p> <ul style="list-style-type: none"> • 'Insert as Hyperlink(s)' and • 'Render as RTF' <p>If you select 'Insert as Hyperlink(s)', a hyperlink is embedded in the document for each dragged object, linking to the object in the Browser window.</p> <p>If you select 'Render as RTF', a prompt displays for you to select the RTF template (if any) from which to generate a small report on the dragged objects. You can select different templates for different objects. However, there must be compatibility between the selected object type (such as Diagram) and the RTF template used (such as Diagram report).</p> <p>You can have hyperlinked objects and RTF-rendered objects in the same document.</p>
Export/Import Views	<p>You export Views to create an XML file that you can:</p> <ul style="list-style-type: none"> • Import into another model as a user-created Model View or • Call from an MDG Technology Selection (MTS) file to access the Technology-defined View provided by the active MDG Technology <p>The export and import functions are available from the Model Views root-node context menus.</p> <p>When you use the export function, it acts on the complete set of View folders in the selected 'My Views' root node, Model Views root node, or user-generated root node; you cannot export individual Views, nor can you export <i>Favorites</i> folders.</p> <p>The function displays the 'Save As' dialog, on which you browse for the directory location for the exported XML file, and specify the file name.</p> <p>When you use the import function, it displays the 'Select Import Filename' dialog on which you browse for the directory and XML file you want to import; the import creates a new Model View folder with the same name as the copied root node.</p>
Set Up a Technology-Defined View	<p>To set up the Technology-defined View for an MDG Technology, you:</p> <ol style="list-style-type: none"> 1. Create a user-generated Model View in Enterprise Architect while using the technology. 2. Populate it with the required View folders and Views. 3. Export the Views from that Model View as an XML file to an appropriate location.

	<p>4. Create a call to the file from the technology's MTS file.</p> <p>Thereafter, any model for which the MDG Technology is active automatically displays those Views in a Technology-defined View.</p>
--	--

Diagram Slide Show

The slide show facility of the Model Views enables you to create and run screen-based presentations of sets of diagrams. When you run a slide show, it displays the diagrams in the folder in the sequence in which they are listed in the folder. After each diagram has been displayed, it is closed. You can use this facility to:

- Create a slide show as a folder within a Views folder under a Model Views node
- Run a slide show manually
- Run a slide show automatically with each diagram displaying for a period that you define
- Display a slide show within the Enterprise Architect work area
- Display a slide show in full screen mode
- Delete a slide show

Access

Ribbon	Start > All Windows > Design > Explore > Focus > Model Views
Keyboard Shortcuts	Alt+1 Focus > Model Views







Create a slide show



Step	Action
1	Under a Model Views node, click on the Views folder to contain the slide show.
2	Right-click on the Views folder and select the 'New Slideshow' option. The 'New Slideshow' dialog displays.
3	In the 'Name' field, type the name of the slide show.
4	Click on the OK button. The new slide show folder is added to the selected View folder.
5	Dock the Browser window separately from the 'Model Views' tab of the Focus window.
6	Drag the diagrams to be displayed as part of the slide show from the Browser window into the new slide show folder. To remove a diagram that is not required, right-click on it in the slide show folder and select the 'Remove Linked Item' option. The diagram items in the slide show folder are links to the diagrams in the Browser window, not copies of the diagrams or the diagrams themselves; any actions you take in the slide show have no impact on the original diagrams.
7	Close the folder.

Define how the slide show is to operate - automated or manual

Step	Action
1	Right-click on the slide show folder and select the 'Properties' option. The 'Slideshow Properties' dialog displays.
2	To automate the slide show, select the 'Enable' checkbox. To run the slide show manually, deselect the checkbox.
3	If you are automating the slide show, in the 'Time' field type the number of seconds that each diagram is to remain on display.
4	Click on the OK button.

Run a slide show of diagrams, in either Diagram View or full screen

Step	Action
1	Right-click on the slide show folder and select either the: <ul style="list-style-type: none"> 'Run Slideshow' option, to run the slide show in the Diagram View 'Run Slideshow Fullscreen' option to run the slide show using the full screen The first diagram in the slide show displays.
2	If you have set up the slide show to run automatically, you can leave it to display the diagrams as defined. You can also moderate the slide show using manual commands.
3	If you are controlling the slide show manually, click on the slide show name. This toolbar displays: 
4	Control the slide show using the toolbar icons or the equivalent aids: <ul style="list-style-type: none"> Display the next slide - , (Spacebar) or (→) Display the previous slide - , (←) Display the first slide - , (↑) Display the final slide - , (↓) Pause the slide show - 

	<ul style="list-style-type: none">• Resume the slide show - • Stop the slide show -  or right-click on the slide show folder name and select the 'Stop Slideshow' option
--	---

Delete a slide show

Step	Action
1	Right-click on the slide show folder and select the 'Remove Slideshow' option. Enterprise Architect prompts you to confirm the deletion.
2	Click on the Yes button. The folder and its list of links to diagrams in the model is removed.

Working Sets

As you perform work on your model, you open various windows, diagrams and views, and you will probably need to return to these same views in a later work session. At the end of your work session, you can capture your current work environment as a working set, which you use to return to that exact environment later, either when you choose to or by having the system automatically recreate it when you next log on to Enterprise Architect. You can also create a working set as an empty definition to which you add specific windows, diagrams and views, from either the 'Working Sets' tab or from a Working Set Artifact element.

You can use the working set to pick up your work from where you left off, or as a set of 'home pages' to start from each day. You can also open multiple working sets, which combines the views from each set. This can be useful to check the progression between different stages in a piece of work.

A working set is initially a personal list, not visible to or active for any other user. You can convert it into a global set to share with other users of your model; for example, if a working set shows a cross-section of an aspect of the model you want to demonstrate or have reviewed.

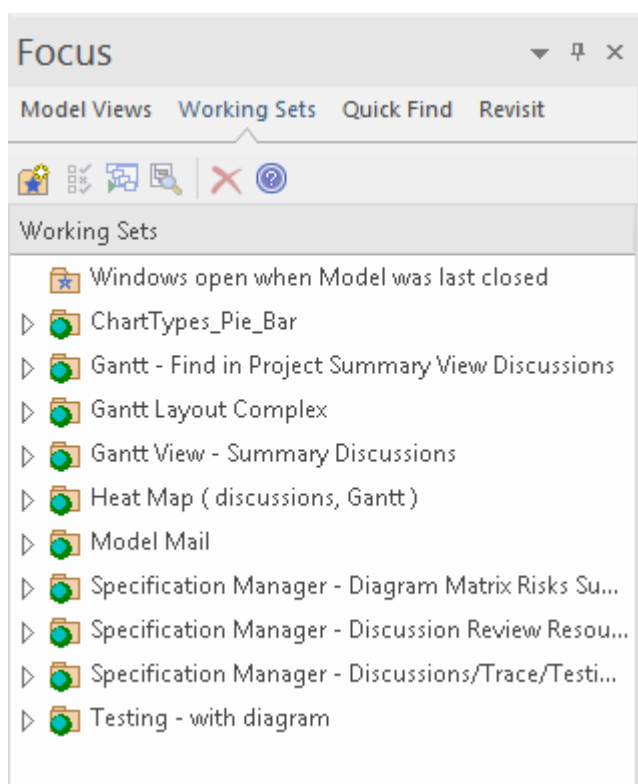



Access



Ribbon	Start > Personal > Working Sets
--------	---------------------------------

Manage Working Sets

Option	Action
Create a working set from	Either:

<p>open diagrams or files</p>	<ul style="list-style-type: none"> • Click on the first icon in the toolbar, or • Right-click on the body of the tab and select the 'Create Working Set' option, or • Right-click on the body of the tab and select the 'Create Working Set From' option, and either the 'Open Diagrams' or 'Open Files' sub-option as appropriate <p>The 'Create Working Set' dialog displays, listing the diagrams and views that are currently open, in the order in which they were opened. If necessary, you can change the order using the 'hand' buttons at the bottom of the dialog.</p> <p>Select the checkbox against each item that you want to retain in the working set, or click on the Include All button. If you selected the 'Create Working Set From' option, the checkboxes against the open diagrams or the open files are already selected.</p> <p>In the 'Name' field, type a name for the working set.</p> <p>You can either:</p> <ul style="list-style-type: none"> • Immediately click on the OK button to create the working set from the selected items, or • Add other selections as described for <i>Create a new working set</i>
<p>Create a new working set</p>	<p>Either:</p> <ul style="list-style-type: none"> • Click on the first icon in the toolbar, or • Right-click on the body of the tab and select the 'Create Working Set' option, or • Switch to an open diagram, drag a 'Working Set' icon from the 'Dynamic Viewpoints' page of the Diagram Toolbox onto the diagram, right-click on the new Working Set Artifact element and select the 'Edit Working Set' option <p>The 'Create Working Set' dialog displays.</p> <p>In the 'Name' field, type a name for the working set.</p> <p>To add a diagram or view, click on the Add Other button and select an option from the list:</p> <ul style="list-style-type: none"> • Add Diagram • Add Matrix Profile • Add Search • Add Library • Add Document Template • Add Resource Document <p>You are prompted to select the required diagram, profile, search, Library topic, document report template or Resource document name(s); each view is then added to the list with its checkbox selected.</p> <p>Click on the Add Other button again, to select the next item.</p> <p>When you have all the diagrams and views you need, click on the OK button to create the working set.</p>
<p>Open an existing working set</p>	<p>A Working Set created on the 'Working Sets' tab is indicated by this icon .</p> <p>A Working Set created as an Artifact element is indicated in the list by this icon .</p> <p>Click on a working set name and either:</p> <ul style="list-style-type: none"> • Select the third icon in the toolbar or • Right-click and select the 'Open Working Set' context menu option <p>Enterprise Architect opens all the diagrams and views listed in that set.</p> <p>If you already have a working set open, the 'new' set of views is added to the original set, with the last-listed diagram or view on top and in focus.</p>

	<p>You open one Model Search, Matrix profile or Library at a time; therefore, the last-opened Search, profile or Library replaces the previous instances.</p>
<p>Automatically apply a working set when the model is opened</p>	<p>Right-click on the working set name and select the 'Apply when model opens' option.</p> <p>This option is a toggle that turns the same option off for the previous working set on which it was selected.</p> <p>The folder turns green, indicating that the option is 'on' for this working set.</p> <p>When you close the model and subsequently open it, the diagrams and views in the working set are automatically opened.</p>
<p>Share a working set</p>	<p>Right-click on the working set name and select the 'Share Working Set' option.</p> <p>The folder icon on the left of the working set name in the list now contains an icon depicting the globe, and the working set is available in the 'Working Sets' tab of every other user of the model.</p> <p>This setting is not reversible; to make the global list into a personal list, make a copy of it.</p>
<p>Add an open view or diagram to a working set</p>	<p>If, in your work, you open a diagram or view that you decide to add to a working set:</p> <ul style="list-style-type: none"> • Click on the 'Working Sets' tab, right-click on the required set name and select the 'Add Active View' option <p>The open view is added to the working set.</p>
<p>Duplicate a working set</p>	<p>If you want to use a variation of a working set without losing the original, you can create a copy and amend that copy as required.</p> <p>Right-click on the source working set and select the 'Copy as New' option.</p> <p>The 'Create Working Set' dialog displays.</p> <p>In the 'Name' field, type a name for the working set.</p> <p>Each of the listed diagrams and views is already selected; make any changes you require, and click on the OK button to save the list as a new working set.</p>
<p>Edit a working set</p>	<p>To change the diagrams and views in a working set, or change the set name, click on the set name and either:</p> <ul style="list-style-type: none"> • Click on the second icon in the toolbar or • Right-click and select the 'Edit' option <p>The 'Create Working Set' dialog displays.</p> <p>Make any changes you require, and click on the OK button to save the changes.</p>
<p>Refresh a Working Set</p>	<p>For shared or Global Working Sets, another user might make a change - such as to the items included - while you have that set applied. If there is a possibility of the Working Set being updated, right-click on it and select the 'Refresh Working Set Items' option to bring your view of the Working Set up to date.</p>
<p>Delete a working set, or a view in working set</p>	<p>Expand the working set and select a specific item (to remove that item) or the set name (to move the whole set)</p> <p>Either:</p> <ul style="list-style-type: none"> • Click on the fifth icon in the toolbar or • Right-click on the set and select the 'Delete Working Set Item' option <p>A prompt displays to confirm the deletion; click on the Yes button.</p>

	<p>The item or set is removed.</p> <p>If you delete a working set that you have opened, the diagrams and views from that set remain open until you specifically close each one or close Enterprise Architect.</p> <p>Note:</p> <ul style="list-style-type: none"> When you create a Working Set on a diagram, using the icon from the 'Common' page of the Diagram Toolbox, the Working Set persists in the Personal Tasks view if you delete the element from the diagram, but not if you delete the element from the model via the Browser window
<p>Save floating window layout in working set</p>	<p>If any of the selected diagrams or views in your working set are floating windows, the 'Create Working Set' or 'Edit Working Set' dialog includes the item 'Save Workspace Layout'.</p> <p>Select this checkbox; the working set captures the complete current workspace layout, including the locations of the floating or docked views.</p> <p>Next time you load the working set, the captured workspace layout is reapplied.</p>
<p>Track working set/views last opened</p>	<p>You might use several working sets in a work session, and close some views and open others.</p> <p>To capture the diagrams and views you actually have open when you close down Enterprise Architect, right-click on the body of the tab and select the 'Store Main Tab View History' option. A new, empty working set folder displays at the top of the list - 'Windows open when Model was last closed'.</p> <p>When you reopen the model in a new work session, this new folder is automatically populated with a list of the diagrams and views that were open when you last closed the model; this is a read-only set that cannot be edited.</p> <p>You can expand the set and double-click on specific windows to re-open them, or right-click on the set and use the 'Open Working Set' option to reopen all the diagrams and views you had open before.</p> <p>However, it is recommended that you use the 'Apply when model opens' context menu option on the set; thereafter, whenever you open the model, all the diagrams and views you had open when you closed the model are automatically re-opened.</p>
<p>Locate a diagram from the working set in the Browser window</p>	<p>Either:</p> <ul style="list-style-type: none"> Right-click on the diagram name and select the 'Find in Project Browser' option, or Click on the diagram name and click on the 'Locate in Project Browser' toolbar icon () <p>The section of the Browser window containing the diagram is expanded, and the diagram name is highlighted.</p>
<p>Locate a Working Set Artifact element in the model</p>	<p>Either:</p> <ul style="list-style-type: none"> Right-click on the element name and select the 'Find in Project Browser' option, or Click on the element name and click on the 'Locate in Project Browser' toolbar icon () <p>The section of the Browser window containing the element is expanded, and the element name is highlighted.</p>

Focus - Quick Find

The 'Quick Find' tab of the Focus window helps you to locate elements and/or diagrams anywhere in the model, by searching for a specified text string in the object name or alias. Objects that match the text string are listed in the 'Elements' tab or 'Diagrams' tab within the 'Quick Find' tab.

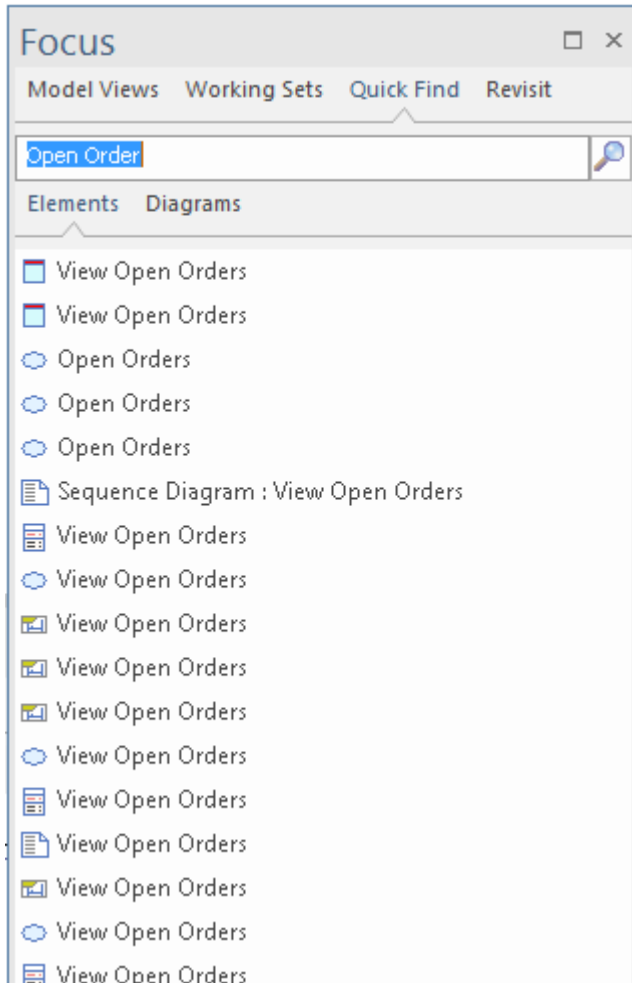

Access

Ribbon	Start > All Windows > Design > Explore > Focus > Quick Find
Keyboard Shortcuts	Alt+1 Focus > Quick Find

Search for Objects

Select the appropriate tab - 'Elements' or 'Diagrams' - and type the text to be searched for into the field above the tab names.

Click on the Search icon - . The results of the search are listed in the selected tab.

If you want to check both elements and diagrams, perform the searches separately. However, the results of the searches remain on display until you execute a new search, so you can compare or match up elements and diagrams that have the same text string.

Act on Search Results

Each list of results has a context menu. Right-click on an item in the list to display the options:

- Properties - displays the 'Properties' dialog for the element or diagram; note that selecting the object also automatically updates the Properties window to show details of the object
- Open - displays the selected diagram in the Diagram View
- Find in Project Browser - locates and highlights the element or diagram in the 'Project' tab of the Browser window
- Find in all Diagrams - if the selected element is used in one diagram, this option opens the diagram and highlights the element

If the element is not used in a diagram, or is used in several diagrams, the options displays the 'Element Usage' dialog - empty if the element is not used, listing the diagrams if it is used; click on the required diagram to open it

Focus - Revisit

The 'Revisit' tab provides links to the diagrams and system windows that you currently have open, and the documents, windows, diagrams and source files that you have recently opened and then closed again.

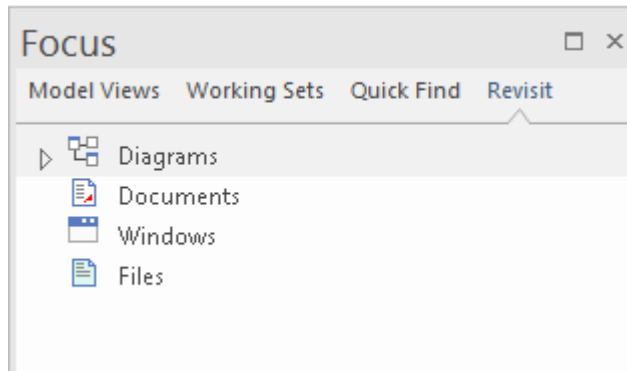

Access

Ribbon	Start > Application > Design > Focus > Revisit
Keyboard Shortcuts	Alt+1 Focus > Revisit

Facilities

Category	Options
Diagrams	This category lists the diagrams that you currently have open - at the top of the list - and the diagrams you have opened and closed recently, in time/date order with the most recently-opened diagram first. You can click on a diagram name to re-access that diagram and resume work on it.
Documents	This category lists the Linked Documents that you have opened recently. If you click on a document name, the document re-opens.
Windows	This category lists the windows that you have opened and closed during the current work session. If you click on a window name, the window re-opens.
Files	This category lists the source files that you have opened and closed recently. You can click on a file name to re-open that file and resume work on it.

The Journal Tab

Enterprise Architect provides a great facility for maintaining a daily log of ideas, comments, notes, suggestions, events, to-do lists and other reminders of what the developers concerned with a selected element or diagram have done or intend to do for the selected object. Like the model-level personal Diary, this is a good way to keep the momentum flowing day to day. The facility is simple to use, allowing you to quickly jot down your thoughts as they occur to you.

The 'Journal' tab is part of the Discuss & Review window, and allows you to record points as you work on, review and discuss the element or diagram with other team members.

Access

Ribbon	Start > All Windows > Collaborate > Discuss & Review Elements Journal, then click on element or diagram Start > Collaborate > Journal Journal, then click on element or diagram
Context Menu	Right-click on element in diagram or Browser window Collaborate Journal Right-click on open diagram or diagram in Browser window Collaborate Journal
Keyboard Shortcuts	Ctrl+9 > Journal

Creating a 'Journal' entry

If you are the first to access the 'Journal' for an element or diagram, it has the single entry 'Today' in the 'Date' column. You can type freely in the 'Journal' column against 'Today', including carriage returns and text formatting. Editing a Journal entry is in most cases the same as entering formatted text into the Notes window, with many options to mark up text, create hyperlinks, use the glossary and similar. Some features, such as the Translation features for Notes are not currently supported in the Journal window.

When you have finished typing your comments, click away from the Journal window and your text will be automatically saved as the editing window loses focus.

You can return to the Journal at any time (as long as another user is not actively updating it) and:

- (Right-clicking on the 'Date' column) Refresh the Journal with any text that another user might have just added
- Add further notes; you and other team members use the same Journal entry to record notes and comments on the element or diagram throughout the day
- Edit the existing text, including reformatting
- Delete text or complete notes; select the text and click on the Delete key or use the 'Delete' context menu option

Journal Entries Each Day

Every day, when you open Enterprise Architect and review the 'Journal' for an element or diagram, it has a 'Today' item at the top, against which you record the day's Journal entries on the selected object. Beneath the 'Today' item are the entries for previous days, identified by the date on which they were made. These only include dates on which an entry was made; there are no blank lines for days on which no entries were made.

As you build up a number of Journal items on an element, you can set the number of items to display (effectively the number of days on which items were posted) in chronological order, starting with today. To do this:

1. Click on the Hamburger icon at the top of the tab and select the 'Show This Many Entries' option.
2. On the submenu, click on the number of days for which to show comments - 1 (Today), 3, 7, 15, 30 or All (every item posted on this object).

You can also pin the currently listed comments for an element or diagram to the tab. Those comments show in the tab regardless of which other object you are working on, which is a useful way of showing instructions written to guide your work on other objects. To pin the comments:

1. Click on the Hamburger icon at the top of the tab and select the 'Pin this comment' option.
2. When you want to display comments for other elements or diagrams, click on the Hamburger icon again and select the 'Unpin Comment' option.

Additionally, you can set the 'Journal' tab and the Discuss and Review window as defaults so that they are displayed each time you log back in for a new work session. To do this, click on the 'Hamburger' icon and select the 'Set this Tab as Default' option.

As well as formatting and editing today's entry, you can edit the entries for previous days. This means you can remove information that is no longer relevant (such as old reminders) or things that were listed to be achieved that are now complete. On the other hand, you can also highlight entries that are still significant, and refer back to them from the 'Today' entry.

Save Journal to File

It is possible to create a report, detailing the Journal entries attached to a model element, and save that report to a document in your file system. You can choose to write the document using RTF, DOCX or PDF file formats.

Access

Menu Option	In the Journal window, click on the menu icon  to display the menu. Choose the menu option "Save Journal to File".
-------------	---

The Dialog Options

Choosing the menu option "Save Journal to File" will open the 'Document Journal Entries' dialog, allowing you to specify the filename into which the Journal report will be saved, and also to specify the number or range of entries to be included in the report.

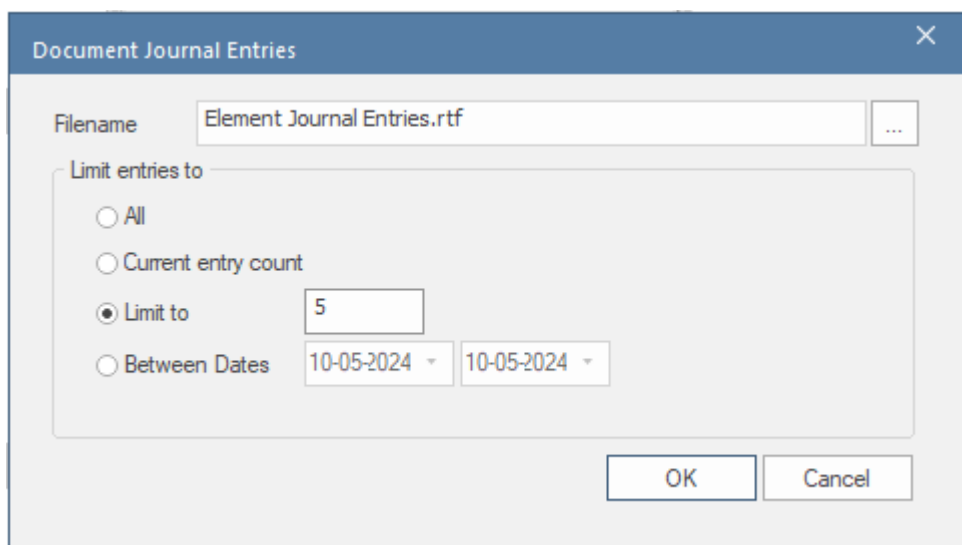

In the Filename field, type a full pathname for the output file, or use the '...' button to browse for a folder and file.

Choose an option for specifying the number or range of Journal entries to include in the report. (The text entered on any given day is considered to be one entry in the Journal.)

Option	Description
All	Include all Journal entries for the selected element in the report.
Current Entry count	Use the 'entry count' currently selected for the Journal window, to select the entries to be included. (All entries visible in the Journal window will be included in the report.)
Limit to	Specify the number of Journal entries (days) to be included.
Between Dates	Specify a range of dates for which the Journal entries will be included.

Document Template

The document is created using the template "**Element Journal**". A default version of this template can be found in the Resources tab of the Browser window. It is located under "**Report Templates > System Templates > Templates**". You can also create a custom version of the template, by right-clicking on the system template and choosing the menu option "**Override**". This creates a copy of the system template, within the "**Custom Templates**" area and opens the new template in the template editor. Here, you can modify the template to suit your requirements. Where a customised version of the template "**Element Journal**" exists, it will be used instead of the system template.

The Inspector Window

The Inspector window provides the facility of examining the details of an individual element, whether held in the current model or in an external data source.

Generally the window has a 'Details' tab listing all the features and characteristics of the element, appropriate to the element type. The categories of features and characteristics are listed even if they do not contain items.

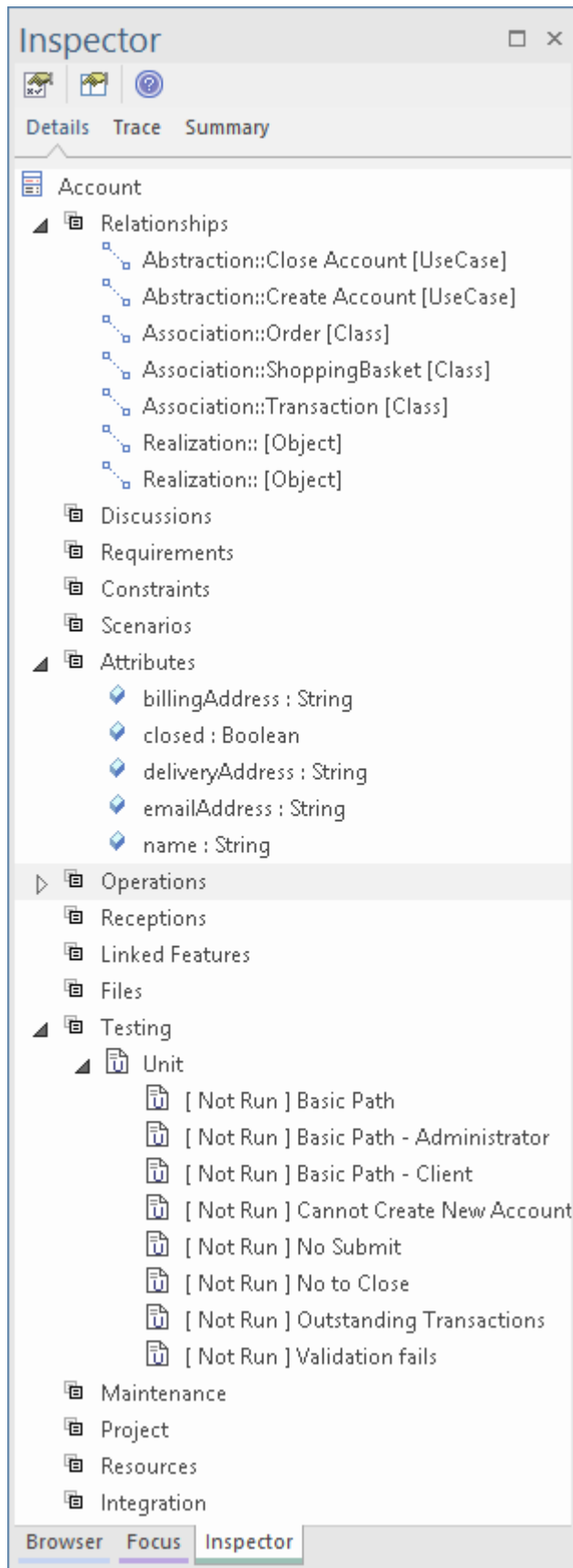

The window also has a 'Trace' tab, which is an instance of the Traceability window for viewing and navigating the dependencies and connections of the currently selected element. The 'Trace' tab has the appearance, facilities and content of the Traceability window, and updates in synchrony with the window.

Similarly, the window has a Summary tab that has the appearance, facilities and content of the Summary window, and updates in synchrony with that window.

If you are working with an external data source in a Cloud-connected model, the Inspector window has another tab - 'External' - that shows the characteristics and features of the selected external data item. In this case, if a category does not contain any items it is not shown in the list.

Inspector Window Toolbar

The Inspector window toolbar provides three icons that enable you to display the full details of a selected item.

Icon	Description
	Select an item and click on this icon to open the appropriate dialog or window and - where appropriate - tab to display the properties of that item. For example, if you had selected an Operation, Attribute or Reception, this icon would display the Features window at the appropriate tab for that item.
	Select an item and click on this icon to make the item the focus of the docked Properties window.
	Click on this icon to display this <i>Inspector window</i> Help topic.

Inspector - Details

As you develop an element in your model, you can define a range of added-on properties of that element through the appropriate dialogs, pages and tabs. It is possible to neatly summarize all of these properties for a selected element, using the 'Details' tab of the Inspector window. The properties listed - where they exist in the element - are grouped by type and include:

- Relationships
- Operations
- Attributes
- Receptions
- Linked Features (Linked attributes and operations)
- Requirements (both external and internal)
- Constraints
- Scenarios
- Related Files
- Testing items (sub-grouped as Unit, Integration, System, Acceptance, Scenario and Inspection tests)
- Resources allocated to the element
- Project management items (sub-grouped as Decisions, Events, Efforts, Risks and Metrics)
- Maintenance items (sub-grouped as Features, Changes, Documents, Issues, Defects and Tasks)
- Discussions
- Integration

These property types are all listed by default. You can filter out types that you don't require, making it easier to find specific items by defining your own filter:

1. Right-click on the 'Details' tab.
2. Select 'Navigation options' from the context menu, to display the 'Select Visible' dialog.
3. Clear the check box against each property type to hide.
4. Click on the Save button; a prompt displays for a name for the selection. You can later select the name and re-apply the filter by clicking on the drop-down arrow to the left of the Save button, or by clicking on the name in the list of sets at the bottom of the 'Details' tab context menu.
5. Click on the OK button.

Having listed the appropriate properties, you can perform a number of operations on them, including dragging and dropping many of them onto other elements.

Access

Click on an element, and then apply one of these access methods:

Ribbon	Design > Element > Properties > General > Element Browser Start > All Windows > Design > Explore > Inspect > Details Explore > Portals > Windows > Explore > Element Browser
Keyboard Shortcuts	Alt+5 Element Browser Alt+1 Inspector > Element Ctrl+1 > Element

Options

Option	Action
List items	<p>If you want to open the list of items of a particular type in the appropriate window, dialog or view (to, for example, review the details of the items) right-click on the list name and select the '<object> List' option, or select any item then use the keyboard shortcut Shift+Enter.</p> <p>Where a list has categories, such as <i>Maintenance</i>, <i>Project</i> or <i>Testing</i>, the option also operates on the selected category. For example, you might list all <i>Maintenance</i> Items in the 'Maintenance Overview' tab of the Maintenance window, or just the <i>Change</i> items in the 'Changes' tab of the Maintenance window.</p> <p>Alternatively, click on the list heading (such as <i>Requirements</i>) and press the / (forward slash) key. There are various other 'hot-key' combinations for different object types that each open a list in the appropriate dialog, but / opens the dialog or window for every object type.</p>
Expand or collapse every list of objects	<p>Right-click on the element name and select the 'Expand All' option to expand the list of every object type in the 'Details' tab. Select the 'Collapse All' option to collapse all the lists and just show the headings. There are keyboard alternatives for these commands - press the Ctrl and + keys, and the Ctrl and - keys, respectively</p>
Copy Item Name to Clipboard	<p>Copy the name of the selected list item to the clipboard by right clicking on it and selecting the 'Copy Item Name to Clipboard' option, then paste it into a text field. If the name has a status prefix in brackets, the copy operation changes the status to the item type. For example:</p> <p style="padding-left: 40px;">Testing Unit [Pass] Verify update</p> <p>If you copy the unit test name and paste it, the name will be:</p> <p style="padding-left: 40px;">[Unit] Verify update</p>
Add items of a specific type	<p>Right-click on the property type name and select the 'New <object>' option. (This option is not applicable to all items, some of which cannot be created without using information external to the selected element.) Or select any item and use the keyboard shortcut Ctrl+N for new items.</p> <p>The appropriate window or dialog displays. Add new or edit existing items as necessary.</p> <p>For example, if you right-click on the <i>Attributes</i> list name and select the 'New Attribute' option (or Ctrl+N), the Features window displays at the 'Attributes' tab, and you can add to or edit the attributes in the element.</p> <p>You can also press the F2 key to open the appropriate window for adding new items or reviewing the existing items of a type.</p>
Edit specific items	<p>Expand the appropriate folder and double-click on the required item. Alternatively, right-click on the item name and select the 'Edit' or 'Edit > <item name>' option, or press the F2 key.</p> <p>The appropriate dialog, docked window or view displays, on which you update the item.</p>
	<p>A number of types of item have no independent existence from the parent element,</p>

Delete a specific item	and can therefore be deleted from the element without impact elsewhere. Such items include Change items, Tasks, Resources and Constraints. To delete an item, right-click on it and select the 'Delete' option.
Drag a relationship onto a diagram	Click on the relationship in the 'Relationships' list and drag it onto the diagram. If the element at one or both ends of the relationship is not already on the diagram, those elements are also added to the diagram. If the relationship is already on the diagram, but hidden, it becomes visible again. Alternatively: <ul style="list-style-type: none"> • Right-click on the <i>Relationships</i> list name and select the 'Place All Related Elements in Diagram' option, or • Right-click on the relationship and select the 'Place Related Elements in Diagram' option
Hide/Show a Relationship in the current diagram	Right-click on the relationship in the <i>Relationships</i> list and select the 'Hide Relationship' or 'Show Relationship' option, as appropriate.
Display the 'Properties' dialog of the other element in the relationship	Right-click on the relationship in the <i>Relationships</i> list and select the 'View Related Element Properties' option.
Locate the related element in the Project tab of the Browser	Right-click on the relationship in the <i>Relationships</i> list and select the 'Locate Related Element' option. The element is highlighted in the 'Project' tab of the Browser window.
Locate the related element in other diagrams	Right-click on the relationship in the <i>Relationships</i> list and select the 'Find in all Diagrams' option.
Open an associated file	Double-click on the required file path within the <i>Files</i> list. If the file can: <ul style="list-style-type: none"> • Be opened within Enterprise Architect, the file opens on a separate tab in the Diagram View workspace • Not be opened within Enterprise Architect, the file opens in the default Windows viewer/editor for the file type
Display the source code for a feature	Right-click on an attribute or operation in the <i>Attributes</i> or <i>Operations</i> list or in the <i>Linked Features</i> list, then click on the 'View Source Code' option. Alternatively: <ul style="list-style-type: none"> • Click on the attribute or operation and press Ctrl+E, or • In the <i>Linked Features</i> list, double-click on the attribute or operation If no code has been generated for the selected feature, nothing happens. If code has been generated for the feature, the code is displayed. The source code viewer in which the source code displays depends on which editor you select as the default, either for the project as a whole or for a specific programming language; if you select the Enterprise Architect internal editor, the code displays in the Source Code Viewer with the cursor positioned on the selected feature.
Move a property to another element	Click on the property in the 'Details' tab and drag it onto the other element in a diagram. The properties you can do this for are: <ul style="list-style-type: none"> • Constraints • Requirements

	<ul style="list-style-type: none">• Maintenance Items• Tests <p>Alternatively, for Maintenance items, right-click on the property and select the 'Move to' option. A list of the elements in the currently-active diagram is displayed; click on the element to move the property into.</p> <p>If you use the 'Move to' option on Testing items, the submenu lists other categories of test on the same element, into which you can move the test details.</p>
Copy a property to another element	<p>As for the Move operation, with the same property/item types, but press the Ctrl key while dragging the item onto its target.</p> <p>There is no equivalent menu option to copy the item.</p> <p>Additional properties you can copy (by simply dragging the property onto the target <i>without</i> pressing the Ctrl key) include:</p> <ul style="list-style-type: none">• Attributes• Operations• Receptions <p>There is a 'Copy to' option for Test items, which copies the test from one test category to another for the same element.</p>
Attach a Recording Marker to an Operation or Signal	<p>Right-click on the object and select the 'Visual Analyzer Set Breakpoint' option, and the option to set the required type of recording marker.</p>

Inspector - Status

The 'Status' tab on the Inspector window provides a quick outline for reviewing the status and priority of all elements of type Requirement in a diagram. This triage tool helps you to focus on what is most important right now, as well as provides a clear view of what can be postponed.

With a diagram selected in the Browser, and the 'Status' tab selected, you can see:

- A list of all elements in a diagram
- An indicator of the element Status
- An indicator of the element Priority

For each element in a diagram there is a line in the 'Status' tab with:

- Element name
- Status icon
- Priority icon

Element	Status	Priority
Requirement A	Yellow circle	Red diamond
Requirement A.1	Blue circle	Yellow circle
Requirement A.1.1	Blue circle	Yellow circle
Requirement A.1.2	Blue circle	Green square
Requirement A.1.3	Blue circle	Dark blue square
Requirement A.2	Green circle	Yellow triangle
Requirement A.2.1	Green circle	Yellow circle
Requirement A.2.2	Green circle	Yellow circle
Requirement A.2.3	Green circle	Green square
Requirement A.3	Yellow circle	Yellow triangle

Note: The listing indent respects the Browser nesting of an element.

Configuring the Status color

The color of the status indicator can be user-defined in the 'Status Types' dialog. The shape for the 'Status' indicator is fixed as a circle. For more details see the *Status Type* Help topic.

Configuring the Priority shape and color

To give each Priority Type a clear visual reference you can assign a particular shape and a color. The shapes available are:

- Square
- Circle

- Triangle
- Diamond

For more details see the *Priority Types* Help topic.

Tracing Relationships

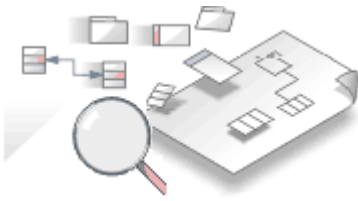

A repository contains a graph of elements connected by relationships; traceability is the ability to explore this graph from a particular starting point in any direction. Modelers commonly think of traceability as just applying to requirements, and the ability to find which elements in the model realize (implement) the requirements; the term is, however, much broader than this and can be applied to any model element. The requirements, for example, could be traced to stakeholders, which in turn could be traced to a set of drivers and goals, and these could be traced to a set of regulatory constraints. Enterprise Architect provides flexible and expressive features that help you to explore and traverse this graph of connections, including the Traceability window and the Relationship Matrix. Enterprise Architect extends the UML by allowing users to trace between model features such as attributes and operations, which is a handy mechanism for the analyst.

Traceability Tools

Enterprise Architect provides a number of tools for tracing the definition and implementation of a process, from initial requirement to generated code or technical deployment, or vice versa. Such tools include the:

- Traceability window, also displayed as the 'Trace' tab of the Inspector window
- Relationship Matrix
- Gap Analysis Matrix
- Relationships window
- Browser window, and
- Traceability diagrams

The Traceability window, in particular, is designed to provide very detailed information on an element's relationships and dependencies, both immediate and distant.

Tracing Transformations

If you have performed any transformations in developing your model and code, Enterprise Architect automatically creates Transformation Dependency connectors that you can trace - using the Traceability window - to establish what objects and code have been generated from each PSM element, or what the initial PSM element was for a generated object.

Whether you use transformations or develop the stages of the model in other ways, you can build up a range of Traceability diagrams (Custom diagrams) to identify the development pathway and the dependencies between entities such as Requirements, Use Cases, Classes, Packages, Test Cases and other model Artifacts, or even between these entities and the overall business process model.

Traceability Tools

The structure of your model and a Traceability diagram act as the starting points for tracing the definition, design and implementation of a specific feature of a system or process. By applying tools such as the Relationship Matrix and Traceability window, you can follow threads through the model to determine how the feature is implemented and tested. You can also obtain information on what elements realize and are realized by the elements in a given Package, using the Dependency report and Implementation report, respectively.

Principal Tools

Tool	Detail
Traceability window	<p>The Traceability window is a very useful and versatile traceability tool; starting with a Traceability diagram or a Package structure in the Browser window, you can use the Traceability window to quickly explore the relationship chain of which any element is a component.</p> <ul style="list-style-type: none"> • When you click on an element, it immediately becomes the top point in the Traceability window • When you click on the background of a diagram, all elements in the diagram are listed in the Traceability window, and you can follow the threads starting at each element through the diagram <p>If you require a rapid, broad-brush view of relationship flows in the project structure, starting with a general list of - say - all functional Requirements, you can use a combination of Model Search, Browser window and Traceability window for scanning your project, identifying how elements have been organized, and seeing how they interact. For example, the Model Search would list all the Requirements. You could rapidly click on each element and immediately see in the Browser window where it has been grouped, and at the same time - in the Traceability window - how that element interacts with other elements in the model.</p> <p>By moving the cursor around a diagram or the Browser window, and/or changing the relationship type combinations in the Traceability window, you can quickly see how elements are connected and how they influence each other. For example, you could see that - say - REQ017 is realized by two Use Cases, so you might then explore what else influences and is influenced by these two Use Cases. The Traceability window takes you well beyond what is likely to be depicted on any single diagram.</p> <p>If you have used transformations to develop your model, you can also follow the Transformation Dependencies that exist between an element in a PIM and elements in the PSMs.</p>
Relationship Matrix	<p>Using the Relationship Matrix, you can both create and study the relationships between, for example, the Requirements and Use Cases of a module.</p> <p>You might identify the 'theme' Package (such as Manage Users) as the source Package in the Requirements model and the target Package in the Use Case model, and explore the likely element and connector types in the Packages; this, similar to the Traceability diagram, identifies which Requirements are (or should be) realized by which Use Cases.</p> <p>You can then perform similar checks with the Manage Users Packages in, say, the Use Case and Implementation models.</p> <p>Using the 'Source' and 'Target' field browsers () you can examine child Packages within the 'theme' Package, and obtain further detail on how the feature at this stage is defined.</p>

Relationships window	<p>The Relationships window shows a single level of relationships from the currently selected element.</p> <p>Each line corresponds to a single relationship, providing information about that relationship and the element at the other end of the relationship.</p>
Dependency report	<p>The Dependency report provides a list of dependencies for all elements in the model.</p>
Implementation report	<p>The Implementation report provides a list of all elements in the model that have to be implemented, and the elements that implement them.</p>

The Traceability Window

Using the Traceability window - or, equally, the 'Trace' tab of the Inspector window - you can quickly see how elements are connected and how they influence each other. You can:

- Locate related elements in the Browser window
- View the properties of related elements
- Open the diagrams in which related elements are used
- Add related elements to the current diagram
- View the source code for related elements
- Change the display using the window toolbar options

When an element is selected, it immediately becomes the top point in the Traceability window. When a diagram is selected, all elements in the diagram are listed in the Traceability window, so you can use any of them as a starting point.

Access

Ribbon	Design > Element > Trace Start > All Windows > Design > Explore > Trace Start > All Windows > Design > Explore > Inspect > Trace (This shows the Traceability window as the 'Trace' tab of the Inspector window)
Keyboard Shortcuts	Ctrl+7 Alt+1 Traceability Alt+1 Inspector Trace

Traceability window toolbar options

Option/Icon	Action
Locate Element	Click on this icon to make the selected element the focus of the Traceability window and to show all relationships and elements with which the selected element forms a relationship chain. Click on the diagram to list all elements in the diagram.
Related Element Properties	Click on this icon to display the element 'Properties' dialog for the currently-selected element in the Traceability window.
Find Element Usage	Click on this icon to display the 'Element Usage' dialog, listing all diagrams in which the currently-selected element is used. (Shortcut keys: Ctrl+U)
(Relationship selector)	Click on the options button  in the toolbar, and select the checkbox against each relationship type to include in the trace shown in the window: <ul style="list-style-type: none"> • Generalizations

	<ul style="list-style-type: none"> • Aggregations • Nesting • Realizations • Dependencies • Transitions <p>Other (unspecified) links such as:</p> <ul style="list-style-type: none"> • Associations • Use Cases • Delegates • Assemblies • Deployments • Information Flows • Manifests • Classifiers - where an element is used as the classifier of another element • Embedded Element Re-uses - where a Port or Part is also represented in another part of the model • Transformations - where an element is created by running a Transformation from another element • Custom References that have been added between elements • Tagged Value References - showing elements that are the targets of Tagged Value references • Qualified Names - element names including the names of owning objects
Help	Click on this icon to display this Help topic.

Traceability Window Context Menu Options

Right-click on an element or connector in the main panel. All options listed here act on elements only, except for the 'Properties' option which acts on connectors.

Option	Description
Switch to Related Element	Make the selected element the focus of the Traceability window. The element displays at the top of the window.
View Related Element Properties	Display the 'Properties' dialog for the selected element. You can also display the element's 'Properties' dialog by double-clicking on it.
Find in all Diagrams	Display the 'Element Usage' dialog, listing all diagrams in which the currently-selected element is used.
Place element(s) in diagram	This option is available if the selected element is not used in the diagram that is the current focus. Select the option to add the element and its child structure to the diagram.
View Source Code	Display the generated source code for the selected element, in the Source Code Editor.

Properties	(For a connector) Display the 'Properties' dialog for the connector. (Double-clicking on a connector expands and collapses any structure beneath it, rather than displaying the 'Properties' dialog.)
------------	--

Notes

- To make it easier and faster to find the elements you are interested in, restrict the relationship types shown to the smallest set of relevant types
- As an alternative view, or to include the traceability information in documentation, you can develop a Traceability diagram using the Traceability window
- The Traceability window does not currently recognize extended relationship types defined by Technologies such as BPMN or ArchiMate; relationships defined by a Profile or Technology are identified using their base UML type, so, for example, ArchiMate 'Realization' and 'UsedBy' relationships are each reported as UML 'Dependency' relationships

Relationship Matrix

When you need to visualize or manage relationships quickly and definitively, you can use the Relationship Matrix - a convenient and simple tool for reporting and working on all the relationships in a selected structure. The Relationship Matrix is a spreadsheet display of relationships between model elements within a Package, or between elements in two different Packages. You can filter the selection of relationships shown, according to:

- The currently-selected Perspective
- The element type of the source and target elements in each relationship
- The relationship type and direction
- The Package(s) in which the source elements and target elements are held

The matrix shows all the relationships of a specified type between source and target elements by:

- Listing the source Package elements down the side of the matrix
- Listing the target Package elements across the top of the matrix, and
- If a relationship exists between a source and target element, displaying an arrow indicating the direction of the relationship

The direction is a reflection of which element is the source element and which the target (it does not indicate the 'Direction' property of the connector, as defined in the connector 'Properties' dialog). The display might also show a 'bent arrow' icon, indicating that the same kind of connectors exist in both directions between the source and target elements.

The squares or cells of the matrix can have different fill colors, depending on the existence of relationships and the lock status of the Package containing the source element. If the cell is:

- White - there is no relationship between the source element in this row and the target element in this column
- Pale Blue - the source element on this row has no relationships at all (if the Matrix Option 'Highlight source elements without relationships' is selected)
- Pale Pink - the target element in this column has no relationships at all (if the Matrix Option 'Highlight target elements without relationships' is selected); if there is an intersection of blue rows and pink columns, the blue takes precedence
- Green - with a direction arrow, the elements in the source row and target column have a relationship and the source element is not locked (the parent Package has not been checked in under Version Control)
- Dark Pink - with a direction arrow, the source element is locked (the parent Package has been checked in)
- Dark Blue - the selected cell, the source element or the target element have been selected as the object of an action within the Relationship Matrix; if just the cell is selected, the source and target element names are also highlighted

Right-clicking on a square gives you the options of creating, modifying and deleting relationships between elements with a single mouse click - a quick way to set up complex sets of element relationships with a minimum of effort.

You can also create additional elements in the source and target Packages, and quickly add relationships to and/or from them.

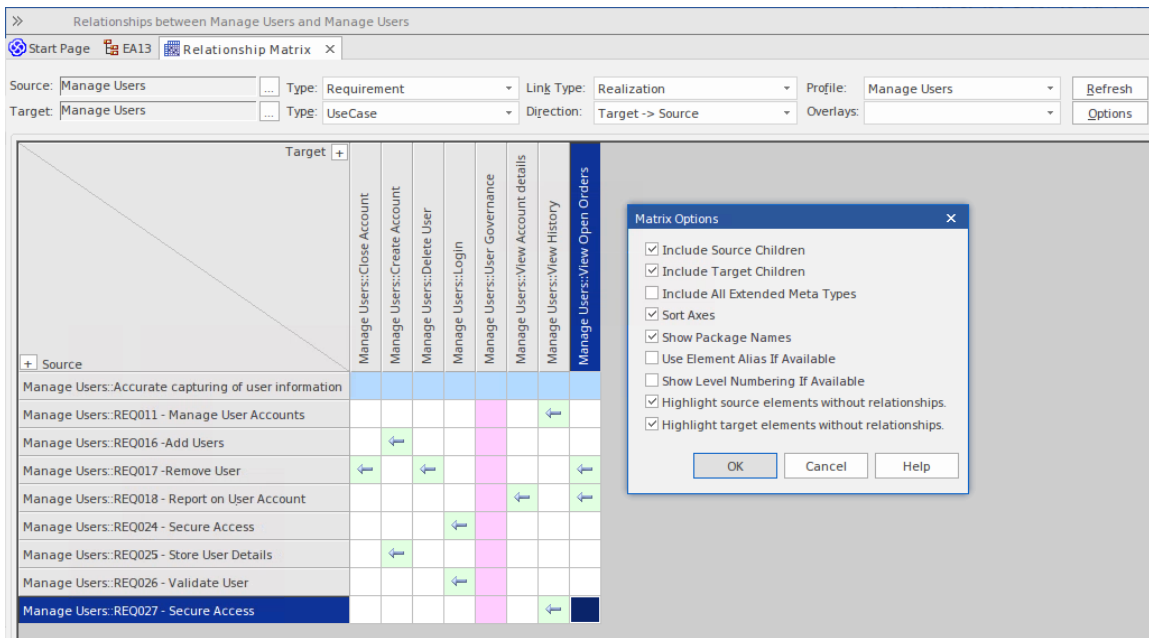

Access

Ribbon	Design > Package > Package/Matrix Open as (Source, Target, Both)
Keyboard Shortcuts	Alt+9 Alt+1 Matrix

Operations

Operation	Detail
Specify the element types	<p>The Relationship Matrix defaults to show all element types available under the current Perspective. If you want to examine relationships between specific types of element, you can filter for those types.</p> <p>You define the element types - if necessary - as the first step in configuring the Relationship Matrix.</p> <p>Click on the drop-down arrow in the 'Type' field in the 'Source' row, and/or in the 'Target' row, and in each case click on the required element type in the list.</p> <p>The Relationship Matrix display immediately refreshes.</p>
Specify the connector type and direction	<p>The Relationship Matrix requires a relationship type and direction to operate on.</p> <p>In the 'Link Type' field, click on the drop down arrow and on the type of relationship to show. The relationship types listed are filtered by the currently-selected Perspective.</p> <p>In the 'Direction' field, click on the drop-down arrow and on one of the connector directions to show, or on 'Both' to show relationships in any direction.</p> <p>In each case, if any relationships of that type exist they are immediately shown on the Relationship Matrix.</p>

Select the Source and Target Packages	You need to set the source and target Packages in order to display relationships, but you do this after setting the connector and element types; as the Matrix automatically refreshes after each change, this is usually faster.
Update, delete and create relationships	Having seen what relationships currently exist between the selected elements, you can review the relationship and element properties, modify them, add more relationships or delete relationships that are no longer applicable.
Create new elements	<p>If the source or target element 'Type' field is set to a specific element type, you can add elements of that type to the matrix and the model.</p> <p>In the top left corner of the matrix itself, the 'Target' and 'Source' labels have a + button. When you click on this button, the element 'Properties' dialog displays, through which you can define a new element of the corresponding (target or source) type.</p> <p>If there are stereotyped elements of the type (such as Actors as defined in UML, TOGAF and ArchiMate) you are prompted to select the variant that you need.</p> <p>This option is not available for the target or source axis if the corresponding 'Type' field is set to '<All>'.</p>
Modify the display of information	It is possible to tailor the display of information to, for example, list the Package elements in alphabetical order, show elements from the Package hierarchy, highlight elements with no relationships, and hide or show additional element name components such as level numbering, aliases and parent Package names.
Toggle Between relationship direction and CRUD formats	You can switch the display between the connector direction format and a CRUD matrix format. The CRUD (or other, customized) indicators are defined in an overlay that you create.
Export the contents of the Relationship Matrix	After reviewing the Relationship Matrix, you can export the contents to a CSV file, or capture the image of the contents as a .png file or a .emf graphics file.
Print the contents of the Relationship Matrix	You can also send the contents of the Relationship Matrix to a printer, after previewing the print format if necessary. The printout can be on as many pages as it takes, or you can scale the print format so that the file occupies a specific number of pages.
Capture the Matrix settings	If you want to use the same Relationship Matrix settings repeatedly to, for example, monitor development of the same source and target Packages, it is possible to save the settings as a profile that can be called to reapply those settings.
Investigate Source and Target elements in relationships	<p>Having identified relationships that might be of significance to you, you can check details of the elements in those relationships. For example, you can look at:</p> <ul style="list-style-type: none"> • The diagrams that the elements are used in • The properties of the elements, or • What other elements might have relationships with the selected element

Set Element Type

The Relationship Matrix defaults to show all element types available under the currently-selected Perspective, in both Source and Target Packages. You can also select to list elements of one specific type in the Source Package or the Target Package or both. For example:

- Any (<All>) types of element in the Source Package linked to Use Cases in the Target Package
- Use Cases in the Source Package linked to any (<All>) types of element in the Target Package
- Requirements in the Source Package linked to Use Cases in the Target Package
- Classes in the Source Package linked to Classes in the Target Package

Having set the element type for an axis, you can create further elements of that type within the Relationship Matrix,

Set the source and/or target element type

Step	Action
1	Click on the drop-down arrow in the 'Type' field for the Source Package, or for the Target Package.
2	Find the required element type in the list and click on it. The Relationship Matrix content automatically refreshes.
3	If necessary, repeat the process to select a specific element type in the other Package.

Set Connector Type and Direction

The Relationship Matrix shows relationships of a specific type and direction, which you define after selecting the element type(s) to show, and before you specify the Source and Target Packages to search in.

Set the connector type and direction

Step	Action
1	Click on the drop-down arrow in the 'Link Type' field.
2	Locate and click on the required connector type in the list.
3	Click on the drop-down arrow in the 'Direction' field.
4	Click on the required direction in the list. The Relationship Matrix content automatically refreshes.

Notes

- If you set the 'Direction' field to 'Both', each relationship is indicated by two arrows - a From-To arrow and a To-From arrow
- The direction is a reflection of which elements are the source elements and which are the target; it does not indicate the 'Direction' property of the connector, as defined in the connector 'Properties' dialog

Set Source and Target Package

Before you display relationships on the Relationship Matrix, you set both the source and target Packages containing the elements between which the relationships might exist. However, you set the source and target Packages after setting the element and connector types/details; as the Relationship Matrix refreshes after each change, this is usually faster. You can set the same Package as the source and target, to investigate relationships within a Package, or different source and target Packages to investigate relationships between Packages.

When deciding on which Packages to investigate and how to filter the matrix contents, consider that:

- The Relationship Matrix includes all child elements in each Package, within the criteria you specify; in a large model, with less-specific filters, this can expand the matrix with a large number of elements
- On the other hand, if you want to examine relationships within the Package structure, you can select options to include elements in child Packages under either the source Package or the target Package, or both

Access

Ribbon	Design > Package > Package/Matrix Open as (Source, Target or Both)
Context Menu	Browser window Right-click on Package Relationship Matrix (As Source, As Target or As Both)
Keyboard Shortcuts	Alt+9 Alt+1 Matrix

Set source and target Packages (method 1)

In all cases, the Relationship Matrix immediately:

- Populates the axes with the elements identified in the 'Source Package' and 'Target Package' or searches that meet the selection criteria, and
- Shows any relationships between the sets of elements that also meet the selection criteria

If you select the first access option:

Step	Action
1	In the Browser window, click on the required source Package, then press and hold Ctrl and click on the required target Package, to select the two Packages together.
2	Drag the selected Packages over the 'Source' and 'Target' fields. The first-selected Package name displays in the 'Source' field, and the second-selected Package name displays in the 'Target' field.

Set source and target Packages (method 2)

Or, if you use the second access option:

Step	Action
1	<p>Select and drag a single Package name over the remaining 'Source' OR 'Target' field, to change just the source or the target Package.</p> <p>If you drop the Package name anywhere else on the Relationship Matrix, the system prompts you to specify whether to add it to the 'Source' or 'Target' field, or both.</p>

Set source and target Packages using Model Search

Step	Action
1	<p>Click on the  button at the end of the 'Source' or 'Target' field.</p> <p>A short menu displays, with options to:</p> <ul style="list-style-type: none"> • Locate a Package using the 'Browse Project' dialog or • Select a Model Search from a drop-down list and run the search on a search term; the name of the search is displayed in the 'Source' or 'Target' field <p>The target of the search depends on whether the 'Return matching items for the selected Package' option is selected in the 'Search' definition; if it is selected, the search operates on the current Package, otherwise the search operates on the whole model</p> <p>It is possible to browse for a Package in one field and run a search in the other.</p> <p>Note: this only supports standard Model Searches. It does not support searches that include a '<Search Term>'.</p>
2	<p>Select the required Package, or the required Model Search and search term, and click on the OK button.</p>

Notes

- Custom SQL searches are supported if they are returning elements; the SQL must include `ea_guid AS CLASSGUID` (case sensitive)
- Using `ORDER BY` in a SQL search will not affect the order of the Relationship Matrix

Matrix Overlays

The Relationship Matrix indicates the existence of connectors between elements by displaying an arrow in the cell at the intersection of the source element row and target element column.

If you prefer, you can toggle the display to a CRUD matrix overlay, where the presence of a connector is indicated by the appropriate value or combination of CRUD values in the intersection cell. You define the actual values that are entered and displayed, so the characters can refer to whatever interpretation of CRUD your organization uses, or they can be another standard set of indicators such as BREAD, or your own custom set of indicators. The values can, therefore, be a selection of these, or anything else you might use:

- C reate
- A dd
- B rowse
- L ist
- R ead, R etrieve
- U pdate
- E dit
- M odify
- D elete, D estroy

Toggle between the two display formats

Click on the 'Overlays' field drop-down arrow and select either:

- '<None>' to use the direction arrow Relationship Matrix format
- The name of your overlay, to use the Matrix overlay format, or
- '<New Overlay>' to create and use a new Matrix overlay

The overlay values display if they have been specifically applied to the relationship via the intersection cell on the Relationship Matrix.

Create a Matrix Overlay

When you create a Matrix Overlay to apply to the cells of the Relationship Matrix, you define the values that can be assigned under that overlay, and whether the values must be single or can be set in a combination. The overlay definition is actually created as a Tagged Value on the connector, of the predefined Tagged Value Type MatrixOverlay.

Access

Ribbon	Design > Package > Package/Matrix Open as (Source/target/Both) : Overlays drop-down arrow <New Overlay>
Context Menu	Browser window Right-click on Package Relationship Matrix (As Source, As Target or As Both) : Overlays drop-down arrow <New Overlay>
Keyboard Shortcuts	Alt+9 : Overlays drop-down arrow <New Overlay> Alt+1 Matrix : Overlays drop-down arrow <New Overlay>

Create an Overlay

Field/Button	Action
Overlay Name	Type an appropriate name for the overlay. This also becomes the tag name.
Allowable Values	Type in the allowable values for the overlay/tag, not separated by any punctuation or spaces (for example, CRUD); the matrix cell is case sensitive, so type the values exactly as they are to be entered.
Mutually Exclusive	If you want only one allowable value to be set in a matrix cell at a time, select this checkbox. (This makes the Tagged Value an Enum type.) If you want to allow any combination of values to be set in a matrix cell at a time, clear the checkbox. (This makes the Tagged Value a Custom type.)
OK	Click on this button to save the new overlay/Tagged Value. You can now view the overlay on the 'Tagged Value Types' tab of the 'UML Types' dialog, in the format: <code>Type=Enum;Values=C,R,U,D;MatrixOverlay=true;</code>

Notes

- You cannot change an existing overlay on the Relationship Matrix; because the overlay is defined by a Tagged Value of type MatrixOverlay, you can delete the overlay or edit the values and/or the 'Mutually Exclusive' setting by deleting or editing the Tagged Value on the 'Tagged Value Types' tab of the 'UML Types' dialog

Apply an Overlay to a Cell

You can apply overlays (one overlay at a time) to the cells of the Relationship Matrix. After you select the required overlay in the 'Overlays' field, you can:

- Apply an overlay value or values to a cell that identifies an existing relationship
- Create a new relationship in a cell, and immediately apply overlay values to that relationship
- Change the overlay values currently applied, or
- Remove the overlay from the cell

Access

Ribbon	Design > Package > Package/Matrix : right-click on cell
--------	---

Context Menu - Overlay Options

Option	Action
Apply overlay	<p>(On a cell that has an arrow icon, or the value of a different type of overlay.) Displays the 'Allowable values <values>' dialog. Type in the required value or values and click on the OK button.</p> <ul style="list-style-type: none"> • If you have entered more than one value and the overlay is set to mutually exclusive, only a single value is permitted and an error message displays; click on the OK button and type in a single character • If the overlay is not set to mutually exclusive, you can type in any individual value, or any combination of values in any sequence
Create new relationship with overlay	<p>(On a cell that has no relationship indicated in it.) If necessary, change the 'Link Type' field to show the type of connector to create. When you click on the menu option, a submenu of variations of the selected relationship type might display. Click on the variation to create. The 'Allowable values <values>' dialog displays; type in the required value or values and click on the OK button. A relationship of the selected type is created between the source and target elements, and the selected overlay values are displayed in the cell.</p>
Edit overlay	<p>(On a cell showing a value of the current overlay.) Displays the 'Allowable values <values>' dialog, showing the current value. Overtyping this with the new value or values and clicking on the OK button. The new value(s) display in the selected cell.</p>
Remove overlay	<p>(On a cell showing a value of the current overlay.) Clears the overlay value and restores the appropriate connector direction arrow symbol to the cell.</p>

Notes

- You cannot apply different overlays to the matrix at the same time; if you select a different overlay in the 'Overlays' field, any values in the cells revert to either the value set under that overlay, or the direction arrow if no value is set under that overlay

Matrix Profiles

You can use the Relationship Matrix as a monitoring tool, to help in tracking the development of elements and relationships in particular Packages or pairs of Packages over time. In this case you would re-use the same combinations of field settings many times. It is very easy to store a combination of settings as a matrix profile, so that later you can recall it for use whenever you need it.

Access

Ribbon	Design > Package > Package/Matrix
Context Menu	Browser window Right-click on Package Relationship Matrix (As Source, As Target or As Both)
Keyboard Shortcuts	Alt+9 Alt+1 Matrix

Save a Relationship Matrix configuration as a named profile

Step	Action
1	Set up the Relationship Matrix with the required: <ul style="list-style-type: none"> • Source and target element types • Connector type and direction • Source and target Packages or Model Searches, and • Overlay name or <None> selected
2	Click on the Options button on the Relationship Matrix and select 'Profiles Save as New Profile'. The 'Enter name for new profile' dialog displays.
3	In the 'Enter Value' field, type a profile name of up to 12 characters. Click on the OK button.
4	Once you have created a profile, you can select it by clicking on the Profile drop-down arrow at the top of the Relationship Matrix screen and selecting the profile name from the list. Profiles are also listed in the <i>Matrix Profiles</i> folder of the 'Resources' tab of the Browser window; double-click on a profile in the folder to display the Relationship Matrix with that profile active.

Notes

- You can modify an existing profile by:
 - Selecting the profile name from the 'Profile' drop-down list

- Changing the field values, then
- Selecting 'Options: Profiles | Update Current Profile'
- To delete an existing profile, select it in the 'Profile' drop-down list and select 'Options: Profiles | Delete Current'
- You can capture Relationship Matrix profiles in document reports
- In the Corporate, Unified and Ultimate Editions of Enterprise Architect, if security is enabled you must have 'Configure Resources' permission to Save, Update, or Delete matrix profiles

Creating and Deleting Relationships

Having reviewed existing relationships on the Relationship Matrix, you can use the Matrix to quickly modify or delete those relationships and create others between the elements. This is a very useful facility for maintaining a large number of relationships in a short space of time. As you can filter for specific types of connector and source and target element, you can create a logical set of relationships without having to specify the type of each object every time.

Access

Ribbon	Design > Package > Package/Matrix Start > All Windows > Design > Tools > Package Matrix
Keyboard Shortcuts	Alt+9 Alt+1 Matrix

Create a new relationship

Note that if the source element (that is, the owner) is locked and the 'Settings > Security > Administer > Apply Locks to Connectors' option is enabled, you cannot create new relationships on that element.

Step	Action
1	In the 'Link Type' field, select the type of relationship you want to create, and in the 'Type' fields select the types of source and target element between which to create the relationships.
2	Right-click on the empty square at the intersection of the appropriate source row and target column. You can select and operate on several squares (creating several relationships) at once. Either: <ul style="list-style-type: none"> • Press Ctrl as you click on each intersecting square, then right-click on one of the selected squares, or • Click on the first square in the required row, column or block, then press Shift as you click on the final square in the required row, column or block; right-click on one of the selected squares
3	Select either the: <ul style="list-style-type: none"> • 'Create new relationship' option, if no overlay is to be applied • 'Create new relationship with overlay' option, to apply an overlay as you create the relationship If the 'Direction' field is set to 'Both', you are offered the choice of creating the relationship to the Source element or to the Target element. A further submenu might display, listing any variations on the type of relationship you can create; in this case, click on the required type of relationship.
4	A connector of the selected type is created between the two elements, and the appropriate indicator displays in the matrix cell.

Modify or delete a relationship on the Relationship Matrix

Step	Action
1	<p>Right-click on the required highlighted relationship cell on the matrix, and select the appropriate context menu option:</p> <ul style="list-style-type: none">• Apply overlay - apply the CRUD overlay, if one is selected• Edit overlay - change the overlay values assigned to the cell• Remove overlay - take the overlay off this cell only, and revert to the connector direction arrow icon• View relationship - open the 'Properties' dialog for the selected relationship• Source element properties - open the 'Properties' dialog for the source element• Target element properties - open the 'Properties' dialog for the target element• Delete relationship - remove the relationship from between the elements
2	<p>If you have selected 'Delete relationship', Enterprise Architect prompts you to confirm this action. Click on the Yes button.</p> <p>The 'Delete relationship' option is not available if:</p> <ul style="list-style-type: none">• The source element (that is, the owner) is locked and the 'Settings > Security > Administer > Apply Locks to Connectors' option is enabled• You have selected 'Both' in the 'Direction' field - you are effectively trying to delete half a relationship
3	<p>If you have selected one of the other options, modify the properties in the dialog fields as required. Click on the OK button to save the changes.</p>

Relationship Matrix Options

When you have displayed information on the Relationship Matrix, you might want to capture the display in some way, or modify the output. There are a number of options that you can select to, for example:

- Output the information on the Relationship Matrix to the printer or to a metafile, .png file or .csv file
- Create and update profiles of the configurations of the matrix that you have designed
- Define local settings to control what the Relationship Matrix displays

Access

Ribbon	Design > Package > Package/Matrix : Options Start > All Windows > Design > Tools > Package Matrix : Options
Keyboard Shortcuts	Alt+9 Alt+1 Matrix : Options

Options

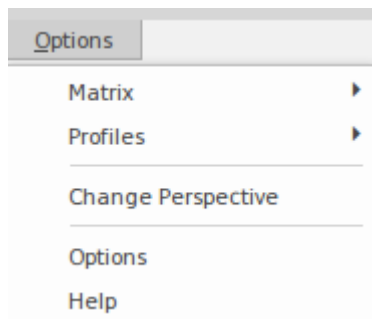

Option	Action
Print Relationship Matrix	Click on the 'Matrix Print' menu option. The 'Print' dialog displays, on which you select the output printer and specify the printer properties, the range of pages to print, and the number of copies. The output is a WYSIWYG representation of the Relationship Matrix contents.
Display a preview of the printout	Click on the 'Matrix Print Preview' menu option. The 'Print Preview' screen displays, showing the Relationship Matrix printout.
Scale the printout	When you print the Relationship Matrix, by default it prints on as many pages wide and long as the Matrix requires. You can scale the printout into a fixed number of pages wide; the row height is automatically adjusted to maintain the proportions of the Matrix. This reduces the overall size of the printout and improves appearance, especially when used in conjunction with the 'Landscape' option in the printer properties. For example, a 16-page printout without scaling can, with a scaling of 2 pages

	<p>wide, be reduced to 6 pages.</p> <p>To set the page scaling:</p> <ol style="list-style-type: none"> 1. Click on the 'Matrix Scale Setting' menu option. The 'Scale Matrix' dialog displays. 2. Select the 'Scale Matrix Width Into Pages' checkbox, and type or select the number of pages in width to scale to. 3. Click on the OK button to apply the setting.
Save Relationship Matrix as graphic file	<p>Click on the 'Matrix Save as Metafile' or 'Matrix Save as PNG' menu options. A browser dialog displays on which you select the target file location and specify the filename of the .emf or .png file in which to save the output.</p> <p>You can incorporate these files in a document or web report, as either a hyperlinked file or an included file.</p>
Export output to CSV file	<p>The contents of the Relationship Matrix can be exported to a CSV file, which provides a convenient mechanism for moving the matrix data to a spreadsheet environment such as Microsoft Excel.</p> <p>This option is also active in the 'Lite', read-only version of Enterprise Architect.</p> <p>To export the Matrix to CSV:</p> <ol style="list-style-type: none"> 1. Select the 'Matrix Export to CSV' menu option. The Windows 'Browser' dialog displays. 2. Browse to the required file location and type in a .csv filename to export to. 3. Click on the Save button to export the data.
Create and manage matrix profiles	<p>If you use a particular combination of field values often, you can save that combination as a profile to make it easier to recall them for use.</p> <p>You can also include a Relationship Matrix Profile in a document report, to pull in specific relationship details using the Matrix.</p>
Change Perspective	<p>The types of element and relationship available to be added to the Matrix are filtered by the Perspective that is currently active. To set the appropriate Perspective for the relationships you are modeling, click on this option and select the required Perspective group and Perspective. The field drop-downs will list values specific to the Perspective.</p>
Manage display content	<p>You can extend the information shown by the Relationship Matrix to include related elements and/or additional properties of each element. You can also re-organize the display to list the element names in alphabetical order.</p> <p>Select the 'Options' menu option. The 'Matrix Options' dialog displays. Select one or more of these checkboxes to define the information you want to display:</p> <ul style="list-style-type: none"> • 'Include Source Children' - to recursively include child Packages and contents under the Source • 'Include Target Children' - to recursively include child Packages and contents under the Target • 'Include All Extended Meta Types' - to include elements that are extensions of a specified meta-type; for example, if there are Block elements (extending Class) in the Package, selecting this option and specifying the type Class includes Class and Block elements, and any further derivatives of Class in the matrix • 'Sort Axes' - to display the element names in alphabetical order • 'Show Package Names' - to hide or show the elements' parent Package names in the Relationship Matrix; this is useful for shortening the displayed texts,

	<p>especially in circumstances where Packages have long names</p> <ul style="list-style-type: none">• 'Use Element Alias If Available' - to display an element's alias instead of the element name, if an alias has been defined• 'Show Level Numbering If Available' - to reproduce level numbering in the Relationship Matrix, if it is turned on in the Browser window• 'Highlight source elements without relationships' - to display, in pale blue, all cells in a row belonging to a source element that has no relationships• 'Highlight target elements without relationships' - to display, in pale pink, all cells in a column belonging to a target element that has no relationships
--	---

Review Source and Target Elements

As you review the information on relationships in the Relationship Matrix, you can also obtain information on the source and target elements in any of the relationships.

Access

Ribbon	Design > Package > Package/Matrix Open as (Source, Target or Both)
Context Menu	Browser window Right-click on Package Relationship Matrix (As Source, As Target or As Both)

Review the elements

Action	Detail
Identify other elements in relationships with a source or target element	Click on the source or target element name in the row or column titles. The entire row or column is highlighted. Scroll across or down the highlighted row or column and quickly identify where the relationships are; this is very useful if the row or column is long.
Display the 'Properties' dialog for the selected element	Right-click on the element name and select the 'Properties' option.
Identify diagrams in which the element is used	Right-click on the element name and select the 'Find in Diagrams' option. Either: <ul style="list-style-type: none"> The only diagram in which the element is used displays, with the element highlighted, or A list of the diagrams in which the element is used displays; you then double-click on the required diagram to open it
Highlight the element name in the Browser window	Right-click on the element name and select the 'Locate in Project Browser' option. The Browser window expands to the location of the element, and the element name is highlighted.
Make the element the focus in any docked screens or windows that are open	Right-click on the element name and select the 'Set Context Item' option; the selected element becomes the subject of any other windows or screens that are open.

The Relationships Window

If you want a quick overview of all the relationships of one element or of several elements in the model, you can obtain this from the Relationships window. This window lists all the relationships of the elements currently selected in a diagram or the Browser window, showing:

- The relationship type
- The direction, or navigability, of the relationship
- Any stereotype on the relationship
- The names of the source and target elements in the relationship (names in parentheses indicate that the element is not shown on the currently-open diagram); the selected elements can be either source or target in the relationship
- Characteristics of the source and target elements, such as type, stereotype, role, cardinality
- The relationships of structured elements (Ports and Parts) on the selected element (the child relationships)

This information is presented in a series of columns that you can display or hide to show only the characteristics you require, and organize in whatever sequence suits your requirements. You can also group the information (for example, by source or target element) and filter the information to show only items having particular values.

The Relationships window has a 'View' column which, if the row contains the value 'Visible' or 'Hidden', indicates that the related element is present in the currently open diagram and the relationship to it is visible or hidden. If the related element is not in the current diagram (the row has no value), you can add it.

You can perform operations on each relationship using the options from a context menu.

Access

Ribbon	Start > All Windows > Properties > Responsibilities > Relations Explore > Portals > Windows > Trace > Relationships
Keyboard Shortcuts	Ctrl+Shift+2

Facilities

Facility	Detail
Reorganize display	You can click on and drag column headings across the display to arrange them in a different sequence. You can also right-click on the column headings and set up the types and values of information to display, using the Field Chooser, Group Box and Filter Bar.
Display connector properties	Either: <ul style="list-style-type: none"> • Double-click on a relationship in the list • Click on the relationship and press the G key, or • Right-click and select 'General Properties' The '<connector type> Properties' dialog displays showing the 'General' tab, on which you can view and edit the connector properties.
Display properties of	

Target Role	<p>Either:</p> <ul style="list-style-type: none"> • Double-click on a relationship in the list and select the 'Role(s)' tab • Click on the relationship and press the T key, or • Right-click and select 'Target Role' <p>The '<connector type> Properties' dialog displays showing the 'Roles' tab, on which you can view and edit the properties of the Target Role defined in the relationship.</p>
Display properties of Source Role	<p>Either:</p> <ul style="list-style-type: none"> • Double-click on a relationship in the list and select the 'Role(s)' tab • Click on the relationship and press the S key, or • Right-click and select 'Source Role' <p>The '<connector type> Properties' dialog displays showing the 'Roles' tab, on which you can view and edit the properties of the Source Role defined in the relationship.</p>
Show child relationships	<p>If the element you want to examine has Ports and Parts, you can select the element together with those structured elements and see relationships involving the element itself and each Port and Part.</p> <p>Alternatively, on the Relationships Window press the C key or right-click and select the 'Expand to Children' option. The list then expands to include relationships on the element's Ports and Parts.</p> <p>This option is particularly useful for SysML diagrams containing Information Flows, where the relationships can be combined into one line.</p>
Hide / Show connector on diagram	<p>If the related element exists on the current diagram, and the connector is shown (the 'View' column has the value 'Visible'), you can hide it. Right-click on the item line and select 'Hide Relation'.</p> <p>If the related element exists on the diagram and the connector is hidden (the 'View' column has the value 'Hidden'), you can re-display it. Right-click on the item line and select 'Show Relation'.</p>
Apply Appearance to one or more connectors on the current element on the current diagram	<p>Select one or more relationships, then right-click and select 'Appearance'.</p> <p>On the 'Connector Appearance' dialog, click on the drop-down arrow in the:</p> <ul style="list-style-type: none"> • 'Line Color' field, and select the color to apply to the connector lines • 'Line Thickness' field, and select the line thickness of the connector lines <p>Click on the OK button to apply the settings to all the selected connectors on the element.</p> <p>For the selected connectors, you can also right-click and select 'Line Style', and one of the listed styles. The style is immediately applied to the connectors on the diagram.</p>
Display the properties of the Source element	<p>Either:</p> <ul style="list-style-type: none"> • Right-click on the relationship item and select 'Source Properties', or • Click on the item line and press the Enter key <p>The element 'Properties' dialog displays for the source element in the relationship.</p>
Display the attributes or operations of the Source element	<p>Right-click on the relationship item and select 'Source Features Attributes' or 'Source Features Operations'. (Alternatively, click on the item and press F9 or F10, respectively).</p> <p>The Features window displays for the source element, showing the 'Attributes' or 'Operations' tab as appropriate.</p>

Display the properties of the Target element	<p>Either:</p> <ul style="list-style-type: none"> • Right-click on the relationship item and select 'Target Properties', or • Click on the item line and press Shift+Enter <p>The element 'Properties' dialog displays for the target element in the relationship.</p>
Display the attributes or operations of the Target element	<p>Right-click on the relationship item and select 'Target Features Attributes' or 'Target Features Operations'. (Alternatively, click on the item and press Shift+F9 or Shift+F10, respectively).</p> <p>The Features window displays for the target element, showing the 'Attributes' or 'Operations' tab as appropriate.</p>
Find a related element in the Browser window	<p>Right-click on the item line and select 'Locate Source' or 'Locate Target' as appropriate.</p> <p>The related element is highlighted in the Browser window.</p>
Add related elements to the current diagram	<p>If any related elements are not shown on the current diagram, then:</p> <ul style="list-style-type: none"> • The 'View' column has no value and • The related element name is in parentheses () <p>You can select the relevant relationships and add the elements to the diagram.</p> <p>Select the item line(s), then right-click and select 'Place Element(s) in Diagram'. The cursor changes to the 'drop element' symbols (small rectangle and arrow with a boxed plus sign); move the cursor to the point in the diagram at which to drop the related elements, and click the mouse button.</p> <p>This facility is useful in building up a picture of how an element interacts with the rest of the model, especially when reverse engineering an existing code base.</p>
Locate related elements in diagrams	<p>Right-click on the item line and select the 'Find in all Diagrams' option.</p> <p>If the related element exists only in one diagram, that diagram is displayed with the related element highlighted. The focus of the Relationships window switches to the related element.</p> <p>If the related element exists in more than one diagram, the 'Element Usage' dialog displays, listing the diagrams. Click on one of the diagrams and on the Open button to display the selected diagram with the related element highlighted.</p>
Delete the relationship	<p>Right-click on the item line and select the 'Delete Connection' option.</p> <p>A prompt displays to warn you that the selected items will be deleted from all diagrams and from the model, and that the action cannot be reversed. This message refers to the relationship only - the source and target elements remain in the diagram and in the model.</p> <p>Click on the Yes button to proceed with the deletion.</p>

Notes

- In the Corporate, Unified and Ultimate Editions, with security enabled, the diagram and the source and target elements must be free for editing before these options are available for use
- Adding a related element from the Relationships window to the diagram does not change the focus of the window to that related element; the originally-selected element (and the original subject of the Relationships window) remains in context, and you continue working with that element

Example Traceability Diagram

You can create Traceability diagrams to show a wide variety of relationships, and you are not restricted to having either a single element type or elements from a single phase on a diagram. Therefore, you can create appropriate relationships (such as Realize or Trace) to elements where no relationship was previously defined.

Consider this diagram, which shows how a series of Requirements are traced to Use Cases and then Classes:

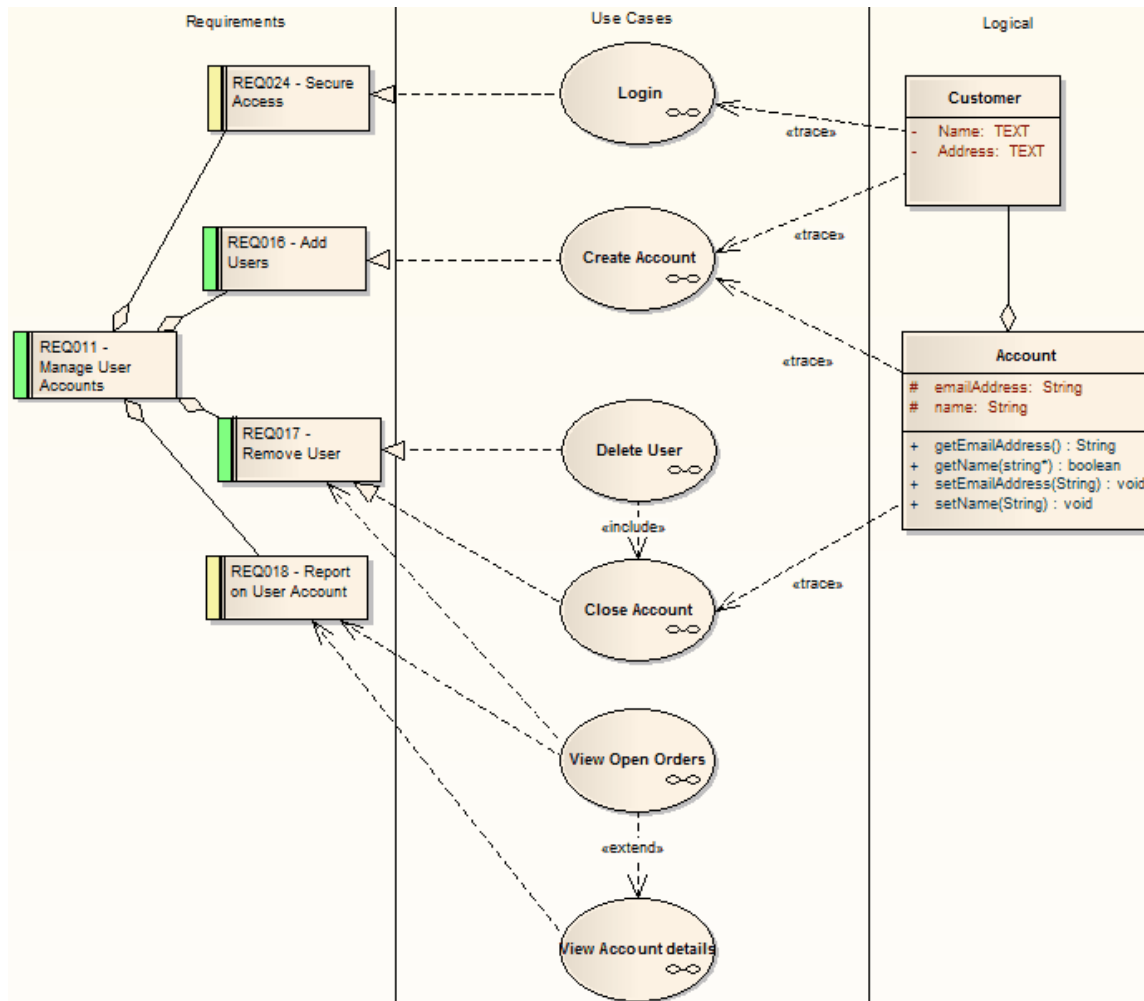

The diagram instantly shows:

- That two levels of Requirements are realized by Use Cases
- Which Requirement is realized by which Use Case(s)
- How some of the Use Cases are implemented by Class elements

You can drill down on each Use Case (or, in other Traceability diagrams, any other composite element) to display more detailed diagrams showing how the Use Case meets the Requirement; the Close Account Use Case, for example, is a composite element containing a Communication diagram and a Sequence diagram.

You can tailor your Traceability diagrams to depict any level of granularity and any stages of development that are appropriate; for example, you might:

- Narrow the example diagram to show development from just the Remove User Requirement, or
- Extend it to include Interfaces, Components, Test Case elements or any other facet of the system or process

Building a diagram

A number of tools are available for updating diagrams to show traceability:

- On the diagram, right-click on an element and select the context menu option 'Insert Related Elements' to automatically add elements linked to the selected element
- On the Relationships window, use the context menu option 'Place Related Element in Diagram' to add elements to the diagram that are directly linked to the selected element
- On the Traceability window, add elements that are indirectly linked

Notes

- Whilst the Traceability diagram itself provides information on the definition, design and implementation of a business process feature, much more information can be obtained using the Traceability tools

Gap Analysis Matrix

The Gap Analysis Matrix is a convenient tool for analyzing model artifacts to identify potential gaps between solutions. The idea is to highlight a shortfall between the original or current solution and proposed improvement; that is, items that have been deliberately omitted, accidentally left out, or not yet defined. You can then model the gaps in the repository, which can later be addressed and assigned as tasks; the identified gaps can also be used to prioritize activities.

On the Gap Analysis Matrix, you select the:

- Target 'Architecture' Package
- Baseline 'Architecture' Package
- Type of Target 'Architecture' artifact
- Type of Baseline 'Architecture' artifact
- Type of element to model the gap

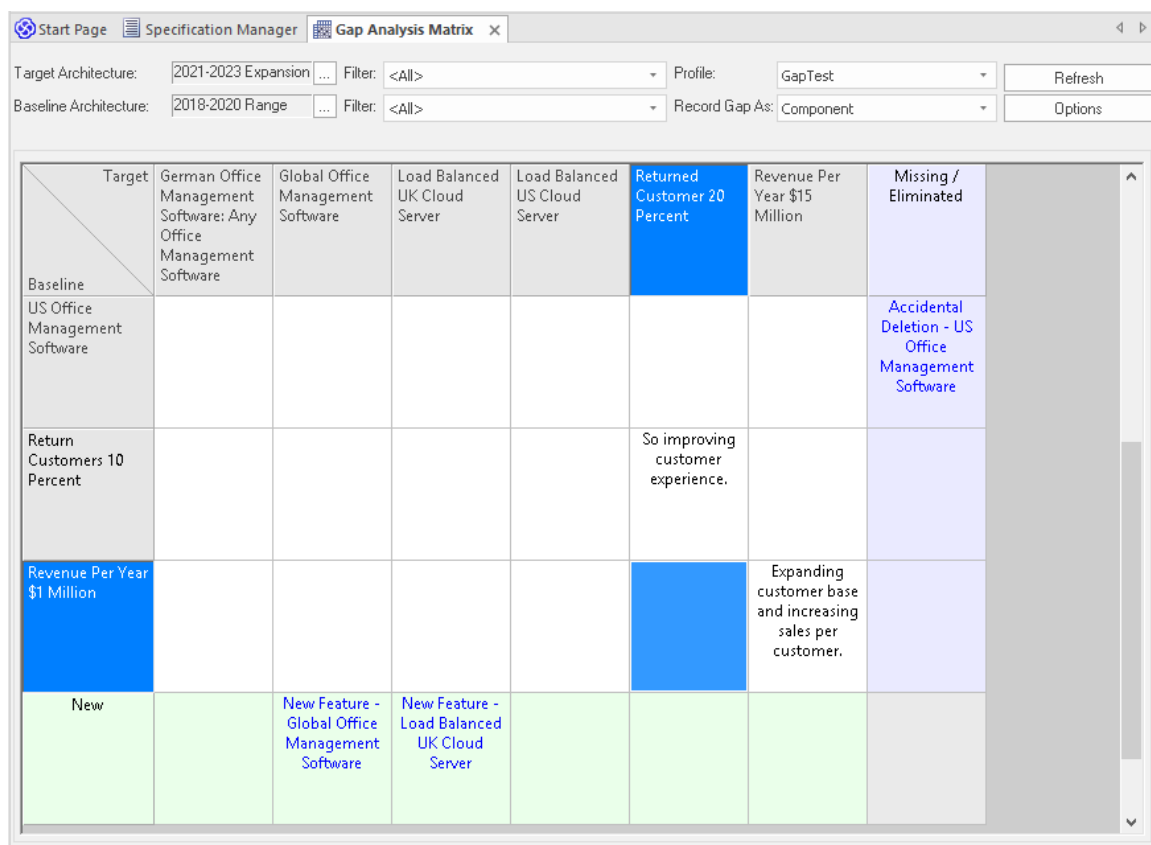

Access

Ribbon	Design > Package > Gap Analysis Start > All Windows > Design Tools Gap Analysis
Keyboard Shortcuts	Alt+1 Gap Analysis Matrix

Operations

Once you open the Gap Analysis Matrix, you can:

- Create, update and delete Gap Matrix Profiles to monitor development of the Baseline and Target Packages
- Edit Gap notes during a discussion session for Gap Analysis
- Create elements to address gaps
- Add links to existing elements to address gaps
- Remove links to existing elements modeled as gaps
- Hide and expand individual rows or columns

Operation	Description
Select Package	<p>Click on the  button at the end of the 'Target Architecture' and 'Baseline Architecture' fields.</p> <p>The 'Find Package' dialog displays.</p> <p>Select the required Package and click on the OK button; by default all the elements under the Package are displayed.</p>
Set Element Type	<p>Click on the drop-down arrow in the 'Filter' field for the Target Architecture Package, and/or for the Baseline Architecture Package.</p> <p>Find the required element type in the list and click on it; Enterprise Architect refreshes the matrix content.</p>
Set Gap Type	<p>Click on the drop-down arrow in the 'Record Gap As' field.</p> <p>Find the required element type in the list and click on it.</p> <p>When you create a Gap element, it is created as the specified type; for example, if you want to address the Gap with an issue element then select 'Issue' for this field.</p>
Baseline Architecture	<p>The Baseline Architecture artifacts are listed as the rows of the matrix.</p> <p>The last row is for capturing the new elements in the Target Architecture along the columns that are not in the Baseline Architecture, hence the name 'New'.</p>
Target Architecture	<p>The Target Architecture artifacts are listed along the columns of the matrix.</p> <p>The last column is for capturing the missing or intentionally eliminated elements in the Baseline Architecture along the rows that are not in the Target Architecture; hence the name 'Missing / Eliminated'.</p>
Modeling Gap	<p>Right-click on a cell in the 'New' row or 'Missing / Eliminated' column.</p> <p>The context menu displays the options:</p> <ul style="list-style-type: none"> • 'Create Gap Element' • 'Link to Existing Gap Element' <p>If a link to a Gap element already exists in the cell, these options are displayed:</p> <ul style="list-style-type: none"> • 'Edit Gap element' • 'Find in Project Browser...' • 'Remove Gap Element Link'
Create Gap	<p>Right-click on the cell and select the 'Create Gap Element' option.</p> <p>The 'Find Package' dialog displays.</p>

	Select the Package in which to create the Gap element and click on the OK button; a Gap element is created in the selected Package and its 'Properties' dialog displays to enable you to enter the element name and other required properties.
Link to Existing Gap	If you intend to use a Gap element that is already available in the model, right-click on the appropriate cell in the 'Missing / Eliminated' column or 'New' row and select the 'Link to Existing Gap Element' option. The 'Select <element type>' dialog displays, enabling you to select the existing Gap element.
Remove Link to Gap	If you intend to remove a link to the Gap element in a cell, right-click on the appropriate cell in the 'Missing / Eliminated' column or 'New' row and select the 'Remove Link to Gap Element' option. The link is removed from the cell but the element still exists in the Browser window.
Review Gap Element	Right-click on the appropriate cell in the 'Missing / Eliminated' column or 'New' row and select the 'Edit Gap Element' option. The 'Properties' dialog displays, enabling you to edit the selected Gap element. To locate and highlight the element in the Browser window, select the 'Find in Project Browser...' context menu option.
Hide Row or Column	If you want to hide a column or row while you focus on a specific aspect of the matrix, you can simply drag the right or lower border of the header cell to hide to the left or upwards to cover the column or row. You can pick up the border and pull it back to expose the row or column again, but it is simpler to just click on the Refresh button to restore the full display.
Gap Analysis Matrix Profiles	On the Gap Analysis Matrix, you can create and manage profiles to save commonly-used combinations of Target Architectures, Baseline Architectures and stereotypes. To work on Gap Analysis Matrix profiles, click on the Options button in the top right corner of the matrix; a submenu displays, listing options to: <ul style="list-style-type: none"> • Save the current matrix settings and content as a new Profile • Update the currently selected profile in the 'Profile' field • Delete the currently selected profile in the 'Profile' field
Open a saved Profile	The 'Profile' field drop-down list shows all the saved Gap Analysis Matrix profiles. Click on the drop-down arrow in the 'Profile' field, find the required profile in the list and click on it to load the content of the selected profile in the matrix.

Notes

- The Gap Analysis Matrix is available in the Corporate, Unified and Ultimate Editions of Enterprise Architect
- You can transport your Gap Analysis Matrix profiles between projects, using the 'Settings > Model > Transfer > Export Reference Data' and 'Import Reference Data' ribbon options

Edit Gap Notes

The Gap Analysis Matrix provides a way to record notes during the initial phase or during a discussion session for Gap Analysis. These notes are saved in the profiles, which can later be reviewed and the appropriate model elements created to address the gaps.

Edit Gap Notes

Step	Action
1	Right-click on the cell at the intersection of a Target column and Baseline row and select the 'Edit Gap Note' option. Alternatively, double-click on the cell. The 'Gap Note' dialog displays.
2	Type in or edit the notes as required and click on the OK button.
3	The edited notes display in the selected cell in the matrix.
4	Update or save the matrix to retrieve the notes when the Gap Matrix profile is loaded at a later stage.

The Search Window



Enterprise Architect has an effective and easy to use search facility that helps you to find elements in a model, based on criteria such as name, the date of creation or modification, type, textual notes and more. There are a number of built-in searches, but even a novice user can easily extend the functionality by defining useful and parameterized searches that can be stored and re-run. When run, the searches return a set of elements that can be located within the hierarchy of the repository or in any diagrams in which they appear; they can even be included in reports. This convenient feature ensures that, regardless of the structure of the model or how large the repository is, you will always be able to locate the information you are looking for.

Facilities

Facility
Model Search - how to use the searching capability within Enterprise Architect to find and display various kinds of information
Create and Modify Searches - how to modify and work with search definitions
Adding Filters - further modifications to searches
Diagram Filters - how to suppress or highlight information in a diagram using customizable filtering mechanisms based on element properties such as status and complexity

Model Search

The Model Search facility helps you to quickly navigate to or find modeling elements within your model. It lists each object that meets the search criteria you specify within the search terms and search type. Many different kinds of searches are already built into the system, and it is possible to create detailed and specific searches of your own. It is also possible to export and share your favorite searches. Having obtained the results of a Model Search, you can perform a range of operations on them to either modify their presentation or to extract and/or report on further levels of detail.





You specify, run and manage the Model Searches through the toolbar at the top of the view.

Access

Ribbon	Explore > Search > Model (or select one of the other specialized categories of search) Start > All Windows > Design > Explore > Search Design > Element > Manage > Search
Keyboard Shortcuts	Alt+I Search or Ctrl+F or Ctrl+Alt+A

Specify a Search

Option	Action
Search Term	Type in the word, phrase or characters to search on.
Search Category	Use the default Common Searches group to filter the types of search you might select from, to the commonest searches used. If you want to use a search from a different functional set, including searches you have created or imported yourself, click on the drop-down arrow and select the appropriate group. Individual searches you have created are contained in the My Searches group. Searches imported as part of a Technology are grouped under the Technology name.
Search	Simple is the first, and most general, of the system-supplied searches in the Common Searches group. If you want to execute a different search in this group, click on the drop-down arrow and select the search from the list. The drop-down list is populated from the search group selected in the first field in the toolbar. To list and execute different searches, change the group in the first field.
Search in Model 	Click on this icon to run the selected search using the search term you have provided.
New Search	Click on this icon to display the 'New Search' dialog, through which you can create

	your own search in the <i>My Searches</i> group.
<p>Copy Search</p> 	<p>If you want to copy an existing search to edit into a new search, select the existing search and click on this icon.</p> <p>The Enter Search Name prompt displays, in which you type a new name for the copied search. The search is automatically copied into the My Searches group.</p> <p>You can now edit this copy to suit your requirements.</p>
<p>Edit Search</p> 	<p>After creating a new or copied search, you can edit the search definition.</p> <p>Click on this icon to open the Query Editor underneath the toolbar. You can use search filters to modify the searches on a search term in order to locate model elements having specific characteristics.</p>
<p>Delete Search</p> 	<p>Click on this icon to delete the search definition from the My Search group and its associated Search drop-down list.</p> <p>The icon is not available for system defined searches or technology-defined searches.</p>
<p>Documentation and QA</p> 	<p>Click on this icon to display a submenu of these options for acting on the results of a Model Search:</p> <ul style="list-style-type: none"> • Edit Notes - select this option to open the Notes window to edit the text of any notes a selected element might have • Generate Documentation - select this option to display the 'Generate Documentation' dialog, through which you can generate a report on one or more selected items from the search results • CSV Import/Export - select this option to specify the CSV export file location into which to export the search results • View Notes - select this option to specify whether to: <ul style="list-style-type: none"> - Hide the text of any Notes each item might have - Display a summary (the first line) of any Notes each item might have - Display the full text of any Notes each item might have • Import Search - select this option to display the 'Windows Directory Explorer Open' dialog, to import searches as XML Search files from an external directory; these searches would have been exported from another user's model or project • Export Search - select this option to display the 'Export Searches' dialog, on which you select the checkbox against each search in your model that you want to export to an external directory as an XML Search file; other users can then import this file into their models, to make the same searches available to them • Dock in Output Bar - select this option to move the 'Find in Project' tab to the System Output window • Dock in Main View - select this option to return the 'Find in Project' tab to the main view in the center of the screen
<p>Result List</p>	<p>The results of the search display in the view area, under a set of column headings that you can reduce, add to and re-arrange to better display the information you need.</p> <p>You can also operate on the items in the search results using the Model Search context menu.</p>

Keyboard Options

When the search has produced results, you can perform a number of simple operations on them using the keyboard keys:

- Display the 'Properties' dialog for the element (double-click or press the Enter key)
- Drag item(s) onto a diagram (Ctrl+drag selected items) - a prompt displays for you to specify how to render the element on the diagram
- Open the Linked Document window for the selected element (press Ctrl+Alt+D)

Notes

You can access the Model Search facilities and perform specific searches indirectly, from Add-Ins, from MDG Technologies, from a hyperlink and from a shortcut to access your model; this entails setting up a search profile, either in the appropriate tool or as an XML file accessed by the tool.

Searching from
An MDG Technology
A Login Shortcut
An Add-In
A Hyperlink

Pre-defined Searches

Enterprise Architect provides a range of pre-defined searches, grouped according to type. Each search is briefly explained here.

Access

Ribbon	Explore > Search > Model Start > All Windows > Design > Explore > Search Design > Element > Manage > Search
Keyboard Shortcuts	Alt+1 Search Ctrl+F or Ctrl+Alt+A
Other	There are many points throughout Enterprise Architect where you can invoke a specific pre-defined search, either to execute immediately without input from you, or to display the Find in Project view where you enter a search term before executing the search. For example, the 'Explore > Search > Diagram', or 'Package' ribbon options.

Common Searches

Search	Description
Simple	Searches the 'Name', 'Alias' and 'Notes' fields of all elements for the given search term.
Extended	Searches many additional fields relating to the element, including attributes, operations, tags and Test Cases.
Element Name	Searches for an exact match against the element name, alias, method or operation; the default search in the 'Search in Model' menu option in the Code Editor.
Attribute Details	Searches for elements with attributes relating to the search term, including Tagged Values, constraints, and common attribute data fields.
Method Details	Searches for elements with operations and methods relating to the search term, including Tagged Values, constraints and common operation and method data fields.
Recently Modified Elements	Searches for elements that have been recently modified, anywhere in the project. The search term relates to any common element field. The default is to show elements modified in the last three days, but you can set an alternative interval by typing the appropriate number of days in the 'Search Term' field.

Find Operations by Name	Searches for the use of a named operation anywhere in the model.
Find Attributes by Name	Searches for the use of a named attribute anywhere in the model.
Find Package	Searches for a named Package in the model.
Find Scenarios	Lists all elements in the project containing defined scenarios.
Schema Profiles	Lists all elements containing Schema Profiles held in the project. You can filter the list by element name, in the 'Search String' field.
Recently Modified Schema Profiles	Locates all elements in the project containing Schema Profiles modified within the previous n days; you specify n in the 'Search String' field.
Recently Modified Linked Documents	Locates all elements in the project containing Linked Documents modified within the previous n days; you specify n in the search string field.
Recently Modified Decision Tables	Locates all elements in the project containing Decision Tables modified within the previous n days; you specify n in the search string field.
Linked Documents	Lists all elements in the project having Linked Documents and having the search term in the element name.
Decision Tables	Locates all elements containing Decision Tables in the project.
Find Baselines	Lists all Packages having Baselines in the project.
Recent Model Group Chat	Lists the chats just between Chat Groups within the elapsed number of days you have specified in the 'Search Term' field. (Effectively, this displays chats between groups with more that two members.) The Chats are listed by Group name in alphabetical order. A GROUPNAME button displays above the column headings, enabling you to toggle between alphabetical order and reverse alphabetical order. Double-click on a chat item to locate and open that item in the 'Chat' tab of the Chat & Mail window.
Recent Model Chat	Lists the chats between individual users and between Chat groups within the elapsed number of days you have specified in the 'Search Term' field. (Effectively, this lists the chats between groups of two or more members.) The Chats are listed by Group name in alphabetical order. A GROUPNAME button displays above the column headings, enabling you to toggle between alphabetical order and reverse alphabetical order. Double-click on a chat item to locate and open that item in the 'Chat' tab of the Chat & Mail window.
Find Model Chat	List all chats from Chat Groups of which you are a member, where the user names, properties or text of the chat contain the text string you have entered in the 'Search Term' field. Double-click on a chat item to locate and open that item in the 'Chat' tab of the Chat & Mail window.

Test and Verification Searches

Search	Description
Failed Internal Tests	<p>Searches the project for elements containing one or more internal test cases where the 'Status' value is 'Fail' and the search term is in any common Test Case field.</p> <p>The output lists the elements and shows their properties; use the 'Construct > Test Management > Tests > All' ribbon option to examine the test records for a selected element.</p>
Tests on Recently Modified Elements	<p>Searches the project for recently modified elements that have test records. In the 'Search Term' field you can specify the number of days over which to check back. If you do not specify a number of days, the search uses a value of 1 day.</p> <p>The output lists the elements that have test records and that have been modified during the specified period, and shows the details of each test record on each element. Double-click on an item to display the 'Test Details' dialog for that test.</p>
Tests Not Run	<p>Searches the project for elements having test records where the 'Status value' is any of: 'Not Run', 'Cancelled' or 'Deferred'. In the 'Search Term' field you can specify the number of days over which to check back. If you do not specify a number of days, the search uses a value of 1 day.</p> <p>The output lists the elements that have test records that have:</p> <ul style="list-style-type: none"> • Been updated during the specified period and • Have a status other than 'Pass' or 'Fail' <p>The output shows the details of each test record on each element. Double-click on the item to display the 'Test Details' dialog for the test.</p>
Tests Not Checked	<p>Searches the project for elements having test records that have no 'Checked By' value. In the 'Search Term' field you can specify the number of days over which to check back. If you do not specify a number of days, the search uses a value of 1 day.</p> <p>The output lists the elements that have test records that have:</p> <ul style="list-style-type: none"> • Been updated during the specified period and • Have an empty 'Checked By' field <p>The output shows the details of each test record on each element. Double-click on the item to display the 'Test Details' dialog for the test.</p>
Passed Tests	<p>Searches the project for elements having test records where the 'Status' value is 'Pass'. In the 'Search Term' field you can specify the number of days over which to check back. If you do not specify a number of days, the search uses a value of 1 day.</p> <p>The output lists the elements that have test records that have:</p> <ul style="list-style-type: none"> • Been updated during the specified period and • Have the status 'Pass' <p>The output shows the details of each test record on each element. Double-click on the item to display the 'Test Details' dialog for the test.</p>
Failed Tests	<p>Searches the project for elements having test records where the 'Status' value is 'Fail'. In the 'Search Term' field you can specify the number of days over which to check back. If you do not specify a number of days, the search uses a value of 1 day.</p>

	<p>The output lists the elements that have test records that have:</p> <ul style="list-style-type: none"> • Been updated during the specified period and • Have the status 'Fail' <p>The output shows the details of each test record on each element. Double-click on the item to display the 'Test Details' dialog for the test.</p>
Deferred Tests	<p>Searches the project for elements having test records where the 'Status' value is 'Deferred'. In the 'Search Term' field you can specify the number of days over which to check back. If you do not specify a number of days, the search uses a value of 1 day.</p> <p>The output lists the elements that have test records that have:</p> <ul style="list-style-type: none"> • Been updated during the specified period and • Have the status 'Deferred' <p>The output shows the details of each test record on each element. Double-click on the item to display the 'Test Details' dialog for the test.</p>
Recently Run Tests	<p>Searches the project for elements having test records where the 'Run Date' field has a value. In the 'Search Term' field you can specify the number of days over which to check back. If you do not specify a number of days, the search uses a value of 1 day.</p> <p>The output lists the elements that have test records that have a 'Run Date' value within the specified period, and shows the details of each test record on each element. Double-click on the item to display the 'Test Details' dialog for the test.</p>

Requirements

Search	Description
Internal Requirements	<p>Searches the project for elements with internal requirements where the search term relates to any common requirement field.</p> <p>The output lists the elements that have requirements containing the search term value, and shows the element properties. To review the requirements, double-click on an item to display the element 'Properties' dialog and select the 'Requirements' page.</p>
Requirements	<p>Searches the project for Requirement element types where the search term occurs in any common element field.</p> <p>The output lists the Requirement elements containing the search term. Double-click on an item to display the 'Properties' dialog for that element.</p>
Recently Discussed Elements	<p>Searches the project for any element that has a recent entry in the Discuss & Review window. In the 'Search Term' field you can specify the number of days over which to check back. If you do not specify a number of days, the search uses a value of 3 days.</p> <p>The output lists the elements that have recent discussions, and their properties. You can display the discussions themselves by pressing Ctrl+9 or selecting the 'Start > Collaborate > Discuss > Discuss' ribbon option, and clicking on the individual entries in the search output.</p>
	<p>Searches the project for any element that has a recent entry in the Discuss &</p>

Recent Element Posts	<p>Review window. In the 'Search Term' field you can specify the number of days over which to check back. If you do not specify a number of days, the search uses a value of 3 days.</p> <p>The output lists the elements that have recent discussions, and the date of the most recent post on each element. You can display the discussions themselves by pressing Ctrl+9 or by selecting the 'Start > Collaborate > Discuss > Discuss' ribbon option, and then clicking on the individual entries in the search output.</p>
----------------------	--

Resource Tracking

Search	Description
Resources	<p>Searches the project for elements with assigned resources, where the search term is the value of any common Resource field.</p> <p>The output lists all elements with assigned resources containing the text string specified as the search term, and shows the properties of each element. To see the assigned resources for an element, click on the item and select the 'Construct > Resource Management > Resources' ribbon option.</p>
Tasks Overdue	<p>Searches the project for elements with assigned resources, where the end date is in the past and the percentage completion is less than 100.</p> <p>The output lists all elements with overdue tasks, and shows the details of the resource allocation to each task.</p>
Active Tasks	<p>Searches the project for elements with assigned resources, where the end date is in the future and the percentage completion is less than 100.</p> <p>The output lists all elements with currently active tasks, and shows the details of the resource allocation to each task.</p>
Tasks Completed	<p>Searches the project for elements with assigned resources, where the percentage completion is 100.</p> <p>The output lists all elements with completed tasks, and shows the details of the resource allocation to each task.</p>
Recently Finished Tasks	<p>Searches the project for elements with assigned resources, where the end date is in the recent past and the percentage completion is 100. In the 'Search Term' field, specify the number of days over which to check back.</p> <p>The output lists all elements with tasks completed within the specified period, and shows the details of the resource allocation to that task. The output does not include tasks that have already been finished in advance of a future completion date.</p>
Tasks Ending Today	<p>Searches the project for elements with assigned resources, where the task end date is today.</p> <p>The output lists all elements with tasks ending today, whether the task is complete or not, and shows the details of the resource allocation to each task.</p>
Tasks Starting Today	<p>Searches the project for elements with assigned resources, where the task start date is today.</p> <p>The output lists all elements with tasks starting today, and shows the details of the resource allocation to each task.</p>

Authors with no Active Tasks	<p>Searches the project for authors who have not been assigned as a resource to any task that is currently active.</p> <p>The output lists all defined authors who have not been assigned to any task that:</p> <ul style="list-style-type: none"> • Is currently less than 100 percent complete or • Has a start date that is not in the future
30-Day Task Summary (Simplified)	Provides a brief summary of the work allocated to each resource over the last 30 days - how many tasks, how much time they took and how much time they were expected to take. Tasks can be grouped into Series, so a resource might have more than one entry in the report, summarizing the work for each series.
30-Day Task Summary (Full)	Provides a brief summary of the work allocated to the resources over the last 30 days, in order of task Group Name. There can be many entries for each resource, depending on the tasks and task groups they have been allocated to.
30 Day Resources	Provides a breakdown of each resource allocation record created or updated during the last 30 days. If you specify search text, the report shows records where the text is included in the resource name.
30 Day Roles	Provides a breakdown of each resource allocation record created or updated during the last 30 days. If you specify search text, the report shows records where the text is included in the role name.

Diagram Searches

Search	Description
Diagram Name	Lists the diagrams that have a name containing the term specified in the 'Search Term' field.
Diagram Details	Lists the diagrams that have the value specified in the 'Search Term' field in one or more of the diagram details fields.
Recently Modified Diagrams	<p>Searches for diagrams that have been recently modified, anywhere in the project.</p> <p>The search term relates to any common diagram properties field.</p> <p>The default is to show diagrams modified in the last three days, but you can set an alternative interval by typing the appropriate number of days in the 'Search Term' field.</p>
Find Bookmarked Elements	Searches for elements that have been bookmarked, anywhere in the project.
Find Kanban Diagrams	Lists all Kanban diagrams in the model and identifies who created them, when they were created and when they were last modified.
Find Orphans	<p>Searches for orphaned elements throughout the model, with the ability to filter on common element fields using a search term.</p> <p>An 'orphaned' element is an element that does not appear on any diagram in the model.</p>

Project Status

Search	Description
My Checked Out Packages	Searches the project for Packages under Version Control that are marked as checked out under your user ID.

Simulation

Search	Description
StateMachine Diagrams	Lists all StateMachine diagrams that exist in the current model, and their properties.
Activity Diagrams	Lists all Activity diagrams that exist in the current model, and their properties.
Recent StateMachine Diagrams	Lists all StateMachine diagrams that you have opened recently. The default is to show diagrams opened in the last seven days, but you can set an alternative interval by typing the appropriate number of days in the 'Search Term' field.
Recent Activity Diagrams	Lists all Activity diagrams that you have opened recently. The default is to show diagrams modified in the last seven days, but you can set an alternative interval by typing the appropriate number of days in the 'Search Term' field.
Executable StateMachines	Lists all Executable StateMachine elements (Artifacts with the <<executable statemachine>> stereotype) in the project, with their element properties.
SysMLSim Configuration	Lists all SysMLSim Configuration elements (Artifacts with the <<SysMLSimConfiguration>> stereotype) in the project, with their element properties.
BPSim Report	Lists all the simulation report results (as BPSim Result Artifacts) in the project, with their element properties.
BPSim Chart	Lists all BPSim Chart elements (both standard and customized) in the project, with their element properties.
BPSim	Lists all BPSim elements (Artifacts with the <<BPSim>> stereotype) in the project, with their element properties.

Changes

Search	Description
Verified Changes	Lists the elements in the project having internal change records that have the status 'Verified' and that are not completed.
Recently Requested Changes	Lists the elements having change records for recent requests that might or might not have been acted on. In the 'Search term' field type the number of days previous to check (the report defaults to 7).
Recently Completed Changes	Lists the elements having change records that were given the status 'Complete' recently. In the 'Search term' field type the number of days previous to check (the report defaults to 7).
New Changes	Lists the elements having change records that have the status 'New' (that is, no action has been taken on them yet).
Incomplete Changes	Lists the elements having change records that do not have the status 'Complete'.

Defects

Search	Description
Verified Defects	Lists the elements in the project having internal defect records that have the status 'Verified' and that are not completed.
Recently Reported Defects	Lists the elements having recently reported defect records that might or might not have been acted on. In the 'Search term' field type the number of days previous to check (the report defaults to 7).
Recently Resolved Defects	Lists the elements having recently resolved defect records that were given the status 'Complete'. In the 'Search term' field type the number of days previous to check (the report defaults to 7).
New Defects	Lists the elements having defect records that have the status 'New' (that is, no action has been taken on them yet).
Unresolved Defects	Lists the elements having defect records that do not have the status 'Complete'.

Issues

Search	Description
Verified Issues	Lists the elements in the project having internal issue records that have the status 'Verified' and that are not completed.
Recently Reported Issues	Lists the elements having recently reported issue records that might or might not have been acted on. In the 'Search term' field type the number of days previous to

	check (the report defaults to 7).
Recently Resolved Issues	Lists the elements having recently completed issue records that were given the status 'Complete'. In the 'Search term' field type the number of days previous to check (the report defaults to 7).
New Issues	Lists the elements having issue records that have the status 'New' (that is, no action has been taken on them yet).
Unresolved Issues	Lists the elements having issue records that do not have the status 'Complete'.

Tasks

Search	Description
Verified Tasks	Lists the elements in the project having internal task records that have the status 'Verified' and that are not completed.
Recently Requested Tasks	Lists the elements having recently requested task records that might or might not have been acted on. In the 'Search term' field type the number of days previous to check (the report defaults to 7).
Recently Completed Tasks	Lists the elements having recently completed task records that were given the status 'Complete'. In the 'Search term' field type the number of days previous to check (the report defaults to 7).
New Tasks	Lists the elements having task records with the status 'New' (that is, no action has been taken on them yet).
Incomplete Tasks	Lists the elements having task records that do not have the status 'Complete'.

Events

Search	Description
Recently Reported Events	Lists the elements having recently created event records that might or might not have been acted on. In the 'Search term' field type the number of days previous to check (the report defaults to 7).
Recently Completed Events	Lists the elements having recently resolved event records (the 'Resolved' checkbox is selected). In the 'Search term' field type the number of days previous to check (the report defaults to 7).
High Priority Events	Lists the elements having event records with a 'Priority' setting of 'High', that have not been resolved.
Open Events	Lists the elements having event records that have not been resolved or completed.

Decisions

Search	Description
Verified Decisions	Lists the elements in the project having internal decision records that have the status 'Verified' and that are not completed.
Recently Created Decisions	Lists the elements having recently-created records for decisions that might or might not have been acted on. In the 'Search term' field type the number of days previous to check (the report defaults to 7).
Recently Effective Decisions	Lists the elements having records for decisions that have recently become effective. In the 'Search term' field type the number of days previous to check (the report defaults to 7).
New Decisions	Lists the elements having decision records that have the status 'New' (that is, no action has been taken on them yet).
Unresolved Decisions	Lists the elements having decision records that do not have the status 'Complete'.

Test Points

Search	Description
Test Suites	Lists the Test Suite elements that exist in the model. Type a text string in the Search Term field to filter for Test Suite elements with that string in the element name.
Test Sets	Lists the Test Set elements that exist in the model. Type a text string in the Search Term field to filter for Test Set elements with that string in the element name.
Test Cuts	Lists the Test Cut elements that exist in the model. Type a text string in the Search Term field to filter for Test Cut elements with that string in the element name.

Publish

Search	Description
Find Model Documents	Searches for and lists all Artifact elements with the stereotype «model document» in the model.
Find Document Packages	Searches for and lists all Packages with the stereotype «master document» or «report package» in the model.

Find Linked Documents	Searches for and lists all elements with linked documents in the model.
Find Custom Documents	Searches for and lists all custom documents in the model.

Database Engineering





Search	Description
Data Models	<p>Searches the project for data model Packages (Packages with the string 'DataModel' in the 'Stereotype' field).</p> <p>The output lists the DataModel Packages with their basic properties.</p>
Database Objects	<p>Searches the project for database objects; that is, Class elements with any of the database object stereotypes. You can filter the list by specifying one of the stereotypes in the 'Search Term' field, or a text string to match text in the 'Alias', 'Name' or 'Notes' fields.</p> <p>The output lists the database object elements with their element properties.</p>
Functions	<p>Searches the project for database Functions; that is, Class elements with the string 'function' in the 'Stereotype' field. You can filter the list by specifying a text string in the 'Search Term' field, to match text in the 'Alias', 'Name' or 'Notes' fields.</p> <p>The output lists the database Function elements with their element properties.</p>
Procedures	<p>Searches the project for database Procedures; that is, Class elements with the string 'procedure' in the 'Stereotype' field. You can filter the list by specifying a text string in the 'Search Term' field, to match text in the 'Alias', 'Name' or 'Notes' fields.</p> <p>The output lists the database Procedure elements with their element properties.</p>
Sequences	<p>Searches the project for database Sequences; that is, Class elements with the string 'sequence' in the 'Stereotype' field. You can filter the list by specifying a text string in the 'Search Term' field, to match text in the 'Alias', 'Name' or 'Notes' fields.</p> <p>The output lists the database Sequence elements with their element properties.</p>
Table Column Datatypes	<p>Searches the project for database Tables that have data types containing the string you specify in the 'Search Term' field. This field must contain a value.</p> <p>The output lists Table elements that have data types containing the specified string, and shows the element properties of each Table.</p> <p>To see the data types, double-click on the item to display its 'Properties' dialog, click on the 'Table Detail' tab and on the Columns button, and review the data types of the columns on the 'Columns and Constraints' dialog.</p>
Table Columns	<p>Searches the project for database Table columns that contain the string you specify in the 'Search Term' field. This field must contain a value.</p> <p>The output lists Table elements that have columns containing the specified string, and shows the element properties of each Table.</p> <p>To see the columns, double-click on the item to display its 'Properties' dialog, click on the 'Table Detail' tab and on the Columns button, and review the columns on the 'Columns and Constraints' dialog.</p>

Table Foreign Keys	<p>Searches the project for database Tables that have Foreign Keys (constraints). You can filter the search by specifying a text string in the 'Search Term' field.</p> <p>The output lists Table elements that have Foreign Keys, and shows the element properties of each Table.</p> <p>To see the Foreign Keys, double-click on the item to display its 'Properties' dialog, click on the 'Table Detail' tab and on the Constraints button, and review the constraints of type FK on the 'Columns and Constraints' dialog.</p>
Table Indexes	<p>Searches the project for database Tables that have Indexes (constraints). You can filter the search by specifying a text string in the 'Search Term' field.</p> <p>The output lists Table elements that have Indexes, and shows the element properties of each Table.</p> <p>To see the Indexes, double-click on the item to display its 'Properties' dialog, click on the 'Table Detail' tab and on the Constraints button, and review the constraints of type Index on the 'Columns and Constraints' dialog.</p>
Table Primary Keys	<p>Searches the project for database Tables that have Primary Keys (constraints). You can filter the search by specifying a text string in the 'Search Term' field.</p> <p>The output lists Table elements that have Primary Keys, and shows the element properties of each Table.</p> <p>To see the Primary Keys, double-click on the item to display its 'Properties' dialog, click on the 'Table Detail' tab and on the Constraints button, and review the constraints of type PK on the 'Columns and Constraints' dialog.</p>
Tables	<p>Searches the project for database Tables; that is, Class elements with the string 'table' in the 'Stereotype' field. You can filter the list by specifying a text string in the 'Search Term' field, to match text in the 'Alias', 'Name' or 'Notes' fields.</p> <p>The output lists the database Table elements with their element properties.</p>
Triggers	<p>Searches the project for Table Trigger elements. You can filter the list by specifying a text string in the 'Search Term' field, to match text in the 'Alias', 'Name' or 'Notes' fields.</p> <p>The output lists the Table Trigger elements with their element properties.</p>
Views	<p>Searches the project for database Views; that is, Class elements with the string 'view' in the 'Stereotype' field. You can filter the list by specifying a text string in the 'Search Term' field, to match text in the 'Alias', 'Name' or 'Notes' fields.</p> <p>The output lists the database View elements with their element properties.</p>

Create Search Definitions

If you want to define your own searches, you can do so using the SQL Editor, Query Builder or an Add-In, through the 'New Search' dialog. User-defined searches are stored in the user application data for the machine being used, and not in the project repository.

Access

Ribbon	Explore > Search > Model :  or Design > Element > Manage > Search Model : 
Keyboard Shortcuts	Ctrl+F :  or Ctrl+Alt+A : 

Create a new search definition

Field/Button	Action
Name	Type a name for the search.
Query Builder	Click on this radio button to create your search through the internal search editor.
SQL Editor	Click on this radio button to create your search by directly writing SQL statements. (For advanced users.)
Add-In Search	Click on this radio button to define the search as a function of an Add-In.
Add-In Name and Method	(Available if you have selected the 'Add-In Search' radio button) Type in: <ul style="list-style-type: none"> • The name of your Add-In • A period (full stop) and • The name of the method to be called whenever the search is run (for example, MyAddin.RunThisMethod); this search can be exported and distributed as a part of your Add-In
OK	Click on this button to create the new search and close the dialog. The search builder panel opens underneath the toolbar. For: <ul style="list-style-type: none"> • An Add-In search, no further action is required; click on the  icon to close the search builder panel • A Query Builder search, the panel defaults to the 'Query Builder' tab and you can start adding filters and constructing the search; see the <i>Define and Modify</i>

	<p><i>Searches topic</i></p> <ul style="list-style-type: none"> An SQL search, the panel defaults to the 'Query Builder' tab and you can start to create the SQL statement for the search, as in <i>Create SQL Search</i> <p>The Search Builder also provides an 'SQL Scratch Pad' tab, which you can use to create and test SQL statements before copying them across to the 'Query Builder' tab.</p> <p>SQL statements on the 'SQL Scratch Pad' are not attached to any search and are not the focus of any operations initiated from the 'Find in Project' toolbar.</p>
Cancel	Click on this button to abort the search creation and close the dialog.

Create SQL Search

You can create SQL statements using the SQL Editor through the 'Query Builder' tab. The SQL editor is based on the common Code Editor, and provides an Intelli-sense autocompletion list populated from the Enterprise Architect repository structure.

To display the autocompletion list, position the cursor after a command and press Ctrl+Space.

A simple search might be to locate an object from a table, given a search term that the user enters in the 'Search Term' field; for example:

```
SELECT * FROM t_object WHERE Name='<Search Term>' (also see the <Search Term> row in the table))
```

In the WHERE statements you can use #xxx# macros as string replacers, so that the same search can be used by different people in different environments. These macros are all case-sensitive. They include:

Macro	Description
#Author#	Takes the user name from the 'Author' field in the 'Preferences' dialog 'General' page, so the defined search can be performed on objects created by that user (this value can be manually re-set in the 'Preferences' dialog). This must be used within a string.
#Branch#	Gets the ID of each child Package under one or more parent Packages, working recursively down to the lowest level of sub-Package. For example: <pre>t_object.Package_ID in (#Branch#)</pre> There are three permutations of this macro: <ul style="list-style-type: none"> in #Branch# - gets the ID of each child Package of the parent Package selected by the user in #Branch=<GUID># or #Branch=<ID># - gets the ID of each child Package of the parent Package specified by the GUID or ID in #Branch=<ID>,<ID>,<ID># - gets the ID of each child Package under each parent Package specified by its ID
#Concat <value1>, <value2>, ...#	Provides a method of concatenating two or more SQL terms into one string, independent of the database type.
#Datepart <field>, <column>#	Provides a method of querying one part of the Date, independent of the database type. The value of <field> can be one of: <ul style="list-style-type: none"> year month day

	<ul style="list-style-type: none"> • dayofyear • weekday • week • dayname
#CurrentElementGUID#	Gets the ea_guid for the currently-selected element. For example: t_object.ea_guid=#CurrentElementGUID#
#CurrentElementID#	Gets the Object_ID for the currently selected element. For example: t_object.Object_ID=#CurrentElementID#
#DB=<DBNAME>#	<p>DBNAME can be one of:</p> <ul style="list-style-type: none"> • SL3 • FIREBIRD • JET • ACCESS2007 • MYSQL • ORACLE • SQLSVR • ASA • POSTGRES <p>This only uses the section of code between two matching #DB=<DBNAME># macros if the current database type matches the specified DBNAME; it can be used where a section of the SQL might require special handling depending upon the current database type. For example:</p> <pre>select * from t_object where #DB=Other#t_object.modifieddate >= now() - 'Search Term'#DB=Other# #DB=SQLSVR#t_object.modifieddate >= getdate() - 'Search Term'#DB=SQLSVR# #DB=ORACLE#t_object.ModifiedDate >= (SYSDATE - INTERVAL 'Search Term' DAY) #DB=ORACLE# #DB=POSTGRES#t_object.modifieddate >= CURRENT_DATE - 'Search Term'#DB=POSTGRES#</pre>
#Left <field>, <count>#	Returns the 'count' number of characters from the field, starting at the beginning of the string.
#Now#	<p>Inserts the current date plus or minus a specified number of hours or days; the default is days (the date format is adjusted to suit the database in use) as in:</p> <ul style="list-style-type: none"> • t_object.ModifiedDate >=#Now <Search Term># <p>For example:</p> <ul style="list-style-type: none"> • t_object.ModifiedDate >= #Now -4d# d is days • t_object.ModifiedDate >= #Now -5h# h is hours • t_object.ModifiedDate >= #Now +3# defaults to days • t_object.ModifiedDate >= #Now#

#Package#	Gets the Package_ID for the currently-selected Package. For example: t_object.Package_ID=#Package#
#Right <field>, <count>#	Returns the last 'count' number of characters from the field.
<Search Term>	Gets the value on which to search, from the text entered in the 'Search Term' field in the Find in Project view (the third field from the left). It therefore functions when an active search is being run and values are being placed in that field. It must appear inside a string, and s required to be in quotes if the table.Field it is being compared with is of type string.
#Substring <field>, <start>#	Returns the remainder of the field beginning at the 'start' character (1-based)
#Substring <field>, <start>, <count>#	Returns the 'count' number of characters of the field starting at character 'start' (1-based).
#UserName#	Gets the name of the person logged into Version Control.; it must be used inside a string. This example is from the built in search 'My Checked Out Packages'. t_package.PackageFlags LIKE '#WC#VCCFG=#WC#CheckedOutTo=#UserName##WC#'
#WC#	Gets the appropriate wild card for the current database, so the search can be performed on models on different databases. It must be used inside a string. For example: t_object.Name LIKE '#WC#Test#WC#'

The GUID and Type

For all functions in which you use a custom SQL statement (including Document Reporting and Model Views) the statement must return the GUID and type of the object found so that the system can search for the selected item in the Browser window. The SELECT statement is case-sensitive and should be typed as shown:

- SELECT ea_guid AS CLASSGUID, Object_Type AS CLASSTYPE, Name FROM t_object

You can extend the usability of your SQL searches using the aliases CLASSGUID and CLASSTYPE, so that you can display the 'Properties' dialog, Tagged Values and icon for elements, connectors, attributes or operations, as well as selecting them in the Browser window. Some simple examples for using these aliased fields are:

- SELECT ea_guid AS CLASSGUID, Object_Type AS CLASSTYPE, Name FROM t_object
- SELECT ea_guid AS CLASSGUID, 'Operation' AS CLASSTYPE, Name FROM t_operation
- SELECT ea_guid AS CLASSGUID, 'Attribute' AS CLASSTYPE, Name FROM t_attribute

Queries for connectors and diagrams can both return types that match the default association to object types. For these tables, you should also return a CLASSTABLE field to allow them to be distinguished from the similar object type.

- SELECT ea_guid AS CLASSGUID, Connector_Type AS CLASSTYPE, 't_connector' as CLASSTABLE, Name FROM t_connector
- SELECT ea_guid AS CLASSGUID, Diagram_Type AS CLASSTYPE, 't_diagram' as CLASSTABLE, Name FROM t_diagram

You can enable your search users to drag and drop elements from the search results onto a diagram, by including one of these in your search SELECT statement:



- (t_object.Object_ID and t_object.Object_Type) or

- `t_object. ea_guid AS CLASSGUID`

When you have defined the SELECT statement, click on the Save button in the 'Query Builder' toolbar to save this search; the search is then available from the 'Search' drop-down list.

SQL Scratch Pad Toolbar buttons

The 'SQL Scratch Pad' tab provides a small number of facilities through its toolbar.

Icon	Description
	Click on this icon to test the search you have defined. The results display in the main panel of the 'Find in Project' view.
	Click on this icon to save the current SQL search as a new search. A prompt displays for the new search name. When you click on the OK button, the system switches to the 'Query Builder' tab, copies the SQL Statement to the tab, and puts the search name into the 'Search' field.
	Click on this icon to clear the 'SQL Scratch Pad' of the current search definition.

Notes

- When you create a custom SQL search on the 'Query Builder' tab, the only two icons that are available in the Toolbar are the Save icon and the Remove Filter icon ; the Remove Filter icon is effectively a Delete icon that removes the search content (the SQL statement)





Define & Modify Searches

Having created a new Query Builder search, you can define the actions of the search using a series of filters on the 'Query Builder' tab of the search editor. A filter is a statement instructing the search to extract objects of a certain type with a specific property having a specific value or a value within a defined range. You can have a number of filters within one search. If you have copied an existing search as a base for the new search, the tab will contain filters already. If the search is completely new, the tab will be empty.



You build up the search definition in two areas:

- The 'Add Filters' dialog, where you can configure the filters to whatever level of precision you require
- The 'Query Builder' tab, where you can modify the filter settings, define how specific a part of the model to search, and test the search

Access

Ribbon	<p>Explore > Search > Model <select search> :  > Query Builder or</p> <p>Design > Element > Manage > Search Model <select search> :  > Query Builder</p>
Keyboard Shortcuts	<p>Ctrl+F <select search> :  > Query Builder or</p> <p>Ctrl+Alt+A <select search> :  > Query Builder</p>



Build a Search

Step	Action
1	<p>Click on the  ('Add Filter') icon to display the 'Add Filters' dialog, and select and define a set of filters.</p> <p>If you already have filters in the search, you can add others of the same filter set by selecting the filter set label (such as 'Attribute') before you click on the icon. The filter items are then refined to that filter set on the 'Add Filters' dialog.</p>
2	<p>If necessary (for example, if you are modifying a copy of an existing search) remove selected filter items.</p> <p>Click on either the filter itself or the filter set heading and click on the  (Remove Filter) icon.</p> <ul style="list-style-type: none"> • If you selected a filter item, it is immediately removed • If you selected the filter set heading, a prompt displays to confirm the deletion; when you click on the Yes button, all filters in the set are removed
3	<p>If you have edited a system-provided search prior to saving it as your own search, and you have decided that the changes are not appropriate, you can 'roll back' to the original settings. Click on the  (Restore Default) icon in the toolbar.</p>

4	Click on the  ('Search Options') icon to set the level of the model to search, and the interaction of the filters.
---	---

Edit Search on Query Builder tab

On the 'Query Builder' tab, you can activate, deactivate and modify the individual filters within the search. This is especially useful for 'tweaking' the search as you test it.

Column	Action
Search In	<p>If the Search contains many filters in a number of filter sets, you can collapse the filter sets you don't want to review, and expand those you do. Click on the expansion box ( ) next to the filter set name, as necessary.</p> <p>Click on the checkbox next to an object property to select it for inclusion in the search, or clear it and omit it from the search.</p>
Condition	<p>If you want to change the condition that the property value must satisfy, click twice on the field to display the drop-down list and select the new Condition.</p> <p>The available options are 'Contains', 'Equal To', 'Not Equals' and 'One Of'.</p>
Look for	<p>In most cases, this field is initially set to <Search Term> to accept a value that the search user types into the 'Search Term' field.</p> <p>If necessary, overtype the current value with one or more specific values to perform the conditional search on.</p> <p>This value should match the selected filter type; for example, the value would be a date for 'DateCreated' or a text value for 'Name'.</p> <p>The search term can consist of multiple values, separated by commas.</p>
Required	<p>Select the checkbox to indicate whether the field is mandatory - that is, whether the search results must only include elements with your search term in that field.</p> <p>These examples show uses of the 'Required' checkbox in the default Simple search, which checks the 'Name', 'Alias' and 'Notes' fields of all elements:</p> <ul style="list-style-type: none"> • If the 'Required' checkbox is not selected for any field, then if the search term is found in the 'Name', 'Alias' OR 'Notes' field for an element, that element is listed in the results • If the 'Required' checkbox is ticked for all fields in the search, then the search term must be found in all of those fields before the element is listed in the results; that is: 'Name' AND 'Alias' AND 'Notes' • If the 'Required' checkbox is ticked for some fields but not others, the search term must be found in all fields for which the checkbox is ticked, and at least one of the fields in which the checkbox is not ticked; that is: Name AND (Alias OR Notes) <p>These checkboxes help you to define the filters on a specific feature (such as an element, diagram or attribute). You can also set up a filter to check for a defined value in <i>every</i> feature included in a search (an AND filter) or in <i>any</i> feature included in the search (an OR filter).</p>

Notes



- When you have set up your search, click on the Save Search icon in the Query Builder toolbar and then the  (Search in Model) icon to run the search and test it

Add Filters

A filter is a statement instructing a search to extract objects of a certain type with a specific property having a specific value or a value within a defined set. You can add a number of filters to a Model Search or Document Generation, to more precisely define the objects or information to extract from the model.

Access

Filters can be applied to a model search, and also to document generation to filter the elements that are reported on.

Model Search	In search window <select search> :  Query Builder : 
Document Generation	In 'Generate Documentation' dialog Element Filters : Add Filter

Add filter criteria to a model search or a document report template

Option	Action
Active Filter Set	<p>Click on the drop-down arrow and select the type of object to search for. Initially, when there are no other filters selected, the drop-down list provides the full range of top-level objects.</p> <div data-bbox="518 1137 954 1742" style="border: 1px solid gray; padding: 5px;"> <ul style="list-style-type: none"> Element Diagram Attribute Attribute.AttConstraint Attribute.AttTagValue Change Custom Property Constraint Method Method.MethodTagValue Method.Parameter Method.PostCondition Method.PreCondition Method.Parameter.ParamTagValue File Issue Defect Scenario TagValue Task Test Responsibility <li style="background-color: #0070C0; color: white;">Resource </div> <p>The object type defines the filter set and once you have selected the object type the drop-down list subsequently only includes objects subordinate to that set. For example:</p> <ul style="list-style-type: none"> • If the initial selection is set to search on 'Element', the drop-down list for subsequent filters on the search will show a list of element properties that you can filter more specifically on • If the initial filter is set to search on 'Diagram', the list for any subsequent filters for the search only contains the 'Diagram' option, as there are no other

	filters that can be applied to a search on diagrams
Add Filter	Select the checkbox corresponding to each field that the search is to evaluate.
Required	Select the checkbox if the object must have this property to be included in the search results.
Field	Provides the name of the field to be checked in the search.
Condition	<p>Click on the drop-down arrow and select the condition that the field value has to satisfy. That is, the field value:</p> <ul style="list-style-type: none"> • Contains • Is exactly Equal to • Is anything other than (Not Equals) or • Is one of a subset of values from <p>the text string in the '<Search Term>' field for the search, or a more specific value defined in the 'Value' field.</p>
Value	<p>If the search is to look for a value provided by the person running the search, leave this field at the default value of '<Search Term>'.</p> <p>Otherwise over-type the field with a specific value or, if the 'Condition' is 'One Of...!', type a selection of values separated by commas.</p> <p>For some filters and conditions, the 'Value' field contains the  button. Click on this to display a selection dialog. This dialog varies dependant on the information required.</p>
Check All	<p>Click on this button to select all of the 'Add Filter' checkboxes to include all filters in the search definition.</p> <p>You might then deselect specific checkboxes to remove a small number of filters from the search.</p>
Uncheck All	<p>Click on this button to clear all selected 'Add Filter' checkboxes to omit all filters from the search definition.</p> <p>You might then select specific checkboxes to include only a small number of filters in the search.</p>
OK	<p>Click on this button to apply the filters to the search definition.</p> <p>The selected filters are displayed in the 'Query Builder' tab for the search definition.</p>
Cancel	Click on this button to close the dialog and cancel the changes you have made.

Notes

- You can add multiple search definitions as necessary; however, if you select the 'Required' field in multiple definitions the search rapidly becomes impractical
- Multiple search definitions are better for 'and/or' searches



Advanced Search Options

The advanced search options help you to apply greater control over how your customized search operates on your model. You can set values and checkboxes in your search definition to find specific criteria within a feature, for example, element properties. However, you can also set filters to run the search across the whole model or a specific Package, and to locate objects that have a specified value in:

- All features (for example, the value exists in an element's properties and one of its attributes' properties) or
- Any one of its features (for example, the value exists in an element's properties or any of its attributes' properties)

The filters for each feature operate on a database table. In the system-supplied searches, for example, filters on element properties operate on the t_element table, filters on attribute properties operate on t_attribute, and filters on method parameters operate on t_operationparams.

Access

From the 'Find in Project' Search window, select a search, then click on the  icon in the Search window toolbar, select the 'Query Builder' tab, then click on the  icon in the Query Builder toolbar.

Other	<select search> :  Query Builder : 
-------	--

Options

Option	Action
Return matching items for the entire model	Defaults to selected, to run the search across the entire model. The search checks every Package in the model, and returns items that match the search criteria from wherever they are located.
Return matching items for the selected Package	Click on this radio button to run the search on a specific Package that the user selects in the Browser window. If the user runs a search and then selects a different Package in the Browser window, the search results do not change until they click on the Search in Model icon again; that is, to search different areas of the project: <ul style="list-style-type: none"> • Click on the first required Package in the Browser window • Click on the Search in Model icon • Check the result • Click on another Package in the Browser window • Click on the Search in Model icon
All Tables	Click on this radio button to list objects that have a match in every feature table checked in the search. For example, only list elements where both the element and one or more of its attributes have the same stereotype name.
	Defaults to selected to list objects that have a match in at least one of the feature

At Least One Table	tables checked in the search. For example, list elements that either have the specified stereotype name, or have attributes that have the specified stereotype name.
OK	Click on this button to apply the settings and close the dialog.
Cancel	Click on this button to cancel any changes you have made and close the dialog.

Customizing the Search View

After you have executed a search and displayed a list of results, you can reorganize the display to show items in a different sequence, add or remove columns for particular characteristics, group the items according to one or more characteristics, and/or select various items from the results.

Access

Ribbon	Explore > Search > Model > Results pane or Design > Element > Manage > Search Model > Results pane
Keyboard Shortcuts	Ctrl+F > Results pane or Ctrl+Alt+A > Results pane

Reorganization Options

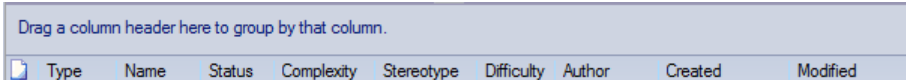
Option	Detail
Sort and Select	<p>In the Model Search you can:</p> <ul style="list-style-type: none"> Sort the items by any column value in ascending or descending order, by clicking on the column header and on the blue arrowhead at the right of that header For a system-supplied search, display the properties of a selected item of any type, by double-clicking on the item Select: <ul style="list-style-type: none"> An item by clicking on it Several individual items by holding Ctrl as you click on them A range of items by holding Shift as you click on the first and last in the range All items in the list by pressing Ctrl+Shift+Alt+A
Change and Resequence Columns using the View Header	 <p>The View Header defines the columns of information that are presented by the Model Search, and the order in which data items are presented.</p> <p>To review the column headings:</p> <ul style="list-style-type: none"> Right-click on the header and select the 'Field Chooser' option; the 'Field Chooser' dialog displays <p>From this dialog, you can add columns to or remove columns from the output; between them, the View Header and 'Field Chooser' dialog show the full range of column headers available.</p> <p>To add a column heading to the View Header:</p> <ul style="list-style-type: none"> Drag it from the 'Field Chooser' dialog onto the header to the position you want the column of data to display in When you have selected the column headings you require, click on the red

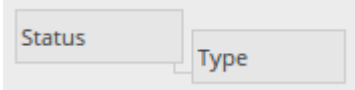
	<p>cross in the top right corner of the 'Field Chooser' dialog to close it</p> <p>To remove a column from the output:</p> <ul style="list-style-type: none"> • Drag the column heading downwards out of the View Header <p>To change the sequence of columns:</p> <ul style="list-style-type: none"> • Drag the required column header left or right, as appropriate
<p>Value Grouping</p>	<p>You can organize the reported data hierarchically according to the value of one or more of the column categories.</p> <p>You might organize the data by 'Type', and within each 'Type' by 'Name'; if you then click on any of the other column headings, the data within this grouping is further sorted with the values of the selected column (for example, 'Created') in ascending or descending order.</p> <p>To set up the value grouping, drag the column heading representing the primary grouping (such as 'Author') onto the 'Drag a column header here to group by that column' field.</p> <p>Now drag the column heading for the next level of grouping (such as 'Status') to the right of the first heading; the two heading titles display as connected blocks, as shown:</p>  <p>You can, if required, add further levels of grouping by dragging other column headings onto the hierarchy (such as 'Created'), and restructure the order by dragging existing or additional headings into the level you want them to hold.</p> <p>For example, you could make 'Type' the secondary grouping by dragging it to the right of 'Author', or drop 'Status' between 'Author' and 'Type'.</p> <p>To remove a grouping level, drag the appropriate column heading out of the sequence and below the View header; any subordinate groupings move up a level.</p> <p>When you have a report with grouped results, you can toggle between the expanded hierarchy and the collapsed (top-level item only) grouping by right-clicking on the View Header and clicking on the 'Collapse All' option.</p>
<p>Filter Bar</p>	<p>The Filter Bar displays underneath the column headings; you can hide or show it by right-clicking on the column headings and clicking on the 'Toggle Filter Bar' option.</p> <p>The Filter Bar consists of a row of fields, one field per column; as you type a value into one of these fields, the Model Search results are automatically filtered to show entries in the corresponding column that contain the value in the field.</p> <p>For example:</p> <ul style="list-style-type: none"> • If you type the letter 'F' in the Filter Bar field under the 'Author' column, the results immediately reduce to entries for which the letter 'F' occurs anywhere in the name (Fred, Fitzgibbon, Rufus, Wolf) • If you then go on to type 'Fi', the results immediately reduce again to entries for which the combination 'fi' appears in the name (Fitzgibbon, Amalfi)

Model Search Context Menu

You can select elements or diagrams in the results of a Model Search and perform various operations on them, as well as simply dragging the item into a Library document or Linked Document. You can:

- Generate reports from search results
- Print search results
- Copy and work with search results
- Manage elements returned by a search

For Packages that are presented in the search results, you can also select an option to open the Package in the Specification Manager.

Access

Context Menu	When you have executed a search, right-click on an item in the search results
--------------	---

Menu Options

Option	Action
Scripts	<p>Click on this option to display a list of any Model Search scripts you have created, which can be executed on the selected item.</p> <p>This option displays only if:</p> <ul style="list-style-type: none"> • You have created Model Search scripts in a Model Search Script Group folder, and • The item results from a successful Query search, or • The item results from a successful SQL search that includes CLASSGUID and CLASSTYPE
Properties	Click on this option to display the 'Properties' dialog for the element.
Copy Selected to Clipboard	<p>Click on this option to copy the selected item to the MS Windows clipboard so that it can be pasted as a link into a diagram, document, spreadsheet or email.</p> <p>Shortcut: Ctrl+C</p>
Documentation	<p>Click on this option to generate a document report on the selected item(s); you have two options:</p> <ul style="list-style-type: none"> • 'Generate a separate report on each selected object in the Model Search' • 'Generate one report on all selected objects' <p>In either case, the 'Generate Documentation' dialog displays.</p> <p>If you generate the report using a custom SQL search, the SQL must include 'ea_guid AS CLASSGUID' and the object type.</p>
Create Linked Document	Click on this option to create (or edit) a Linked Document on the selected element.

(Edit Linked Document)	(Available in the Corporate, Unified and Ultimate Editions). Shortcut: Ctrl+Alt+D
Delete Linked Document	Click on this option to delete an existing Linked Document. (This option only displays if the element has a Linked Document.) A prompt displays to confirm the deletion. Click on the Yes button.
Print	Click on this option to print out the results as currently displayed. The 'Print' dialog displays, on which you select the printer and define the print run.
Clear Results	Click on this option to clear the search results from the display.
Find in Diagrams	Click on this option to display the diagram that depicts the element or, if the element is used in multiple diagrams, display a list of diagrams to choose from.
Find in Project Browser	Click on this option to highlight the element in the Browser window. (Some reportable objects are not shown in the Browser window; if you select one of these, this option is not available.)
Specification Manager	(For a selected Package in the search results.) Click on this option to open the Specification Manager and display the Package contents in it. If you generate the report using a custom SQL search, the SQL must include 'ea_guid AS CLASSGUID and Object_Type AS CLASSTYPE' in order for the Specification Manager to display the Package.
Bookmark Item	Click on this option to add or clear a bookmark on the element. A small dialog displays on which you select the appropriate radio button to set the bookmark on or off. If you set the bookmark on, a red triangle (or red Delta symbol) is displayed on the element icon in the results. If you clear the bookmark, the red triangle is removed.
Delete Selected	Click on this option to delete the selected element from the Model Search results. A prompt displays to confirm the deletion; click on the Yes button.
Help	Display the Help topic on the Model Search.

Add Items To Linked Document

A very useful feature of the Model Search facility is the ability to drag separate items from the Search results into an existing Linked Document.

To do this you create your Linked Document, run the Model Search, and open the document and Model Search view as docked windows. You then drag the items - individually or as a multiple selection - from the search results into the document. You are prompted to select one of two options:

- 'Insert as Hyperlink(s)' and
- 'Render as RTF'

If you select 'Insert as Hyperlink(s)', a hyperlink is embedded in the document for each dragged object, linking to the object in the Browser window.

If you select 'Render as RTF', a prompt displays for you to select the RTF template (if any) from which to generate a

small report on the dragged objects. You can select different templates for different objects. However, there must be compatibility between the selected object type (such as Diagram) and the RTF template used (such as Diagram report), otherwise nothing is shown in the document.

You can have hyperlinked objects and RTF-rendered objects in the same document.

Notes

- Running a custom or diagram-based search disables some context menu options

The Summary Window

The Summary window shows a brief, read-only summary of the general properties of the currently selected:

- Element (including Packages)
- Attribute
- Operation
- Test
- Maintenance item
- Resource

It does not display details for Views, Model Packages, diagrams, instances or connectors.

The Summary window immediately displays general information on the item in context, so you can quickly scan a number of items to locate and check those of interest to you. You can highlight a section of text or the complete content, and copy it to be pasted into an external document.

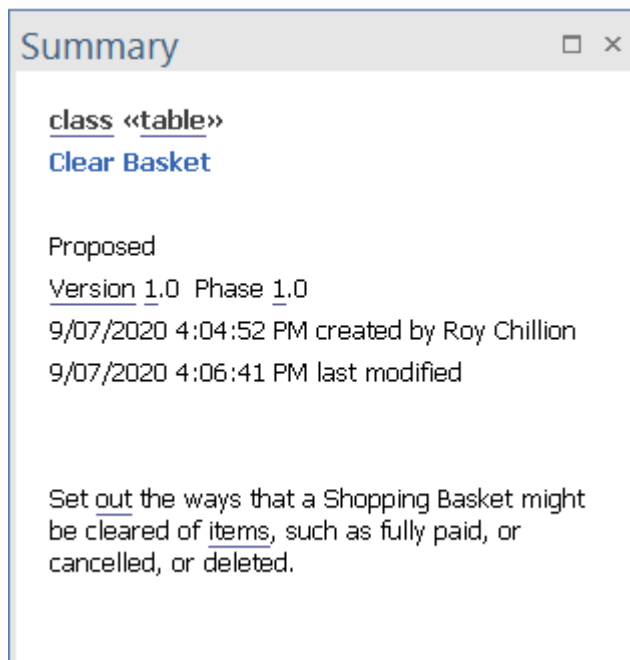

The window is mirrored by the 'Summary' tab of the Inspector window; the 'Summary' tab and Summary window always remain in synchrony.

Access

Ribbon	Start > All Windows > Design > Summary Start > All Windows > Design > Inspect > Summary
Context menu	In the Browser window, right-click on the object Properties Summary
Keyboard Shortcuts	Ctrl+6 Alt+1 > Summary Alt+1 > Inspect > Summary

Context Menu Options

Right-clicking within the Summary window will display a context menu, offering the following commands:

Option	Description
Remove PIN	'Unpins' the text in the Summary window. When different model elements are selected, the displayed content is updated to show summary information for the currently selected element.
PIN This	'Pins' the text in the Summary window. The displayed content of the window will remain unchanged, even as different model elements are selected.
Search for >	Displays options to search in the model, or in files, for text 'selected' in the Summary window.
Copy	Copy to the clipboard, all text that has been 'selected' in the Summary window.
Select All	Select all of the text in the Summary window.
Print	Print the contents of the Summary window.
Help	Display this page of the User Guide in a web browser.

The Package Browser

If you want to quickly create and operate on elements in a Package, you can use the Package Browser as a workbench. The Package Browser is a tabular, editable view of the elements in a selected Package, which can be displayed either in the main View or as a floating window, and as either a List display or a Gantt chart. It can be particularly useful for setting up a Package for a specific purpose, such as when an Analyst creates and maintains formal requirement definitions within the model. When you have checked the contents of the Package, you can either print the list of elements or generate a document report on all or a subset of the elements.

You can open more than one instance of the Package Browser, to review different Packages at the same time. Each instance of the Package Browser is a separate window or View, identified by the Package name.

The Package Browser is related to, and can be used in conjunction with, the:

- Diagram List, which lists the elements in a selected diagram, and
- Specification Manager, which is a document-based interface to the Package, providing the means of creating and reviewing elements as text representations of model objects in that Package

Access

Ribbon	Design > Package > List View Design > Package > Gantt View
Context Menu	Right-click on Package Open Package in List View Right-click on Package Open Package in Gantt View
Keyboard Shortcuts	Ctrl+Alt+R (view as list)

Features

Feature	Detail
Select List View or Gantt View	<p>When you select one of these menu paths, you select either the List View of the Package Browser, or the Gantt View.</p> <ul style="list-style-type: none"> • List View lists all the elements in the Package, with their properties; you can manipulate this display using various menu options • Gantt View lists all the elements in the Package, grouped by model hierarchy, but showing the work timeline for each element and for each resource assigned to work on the element, and the percent-completion of all tasks associated with each element <p>Once you have displayed one of these views, you can switch to the other by right-clicking on the display and selecting the appropriate context menu option:</p> <ul style="list-style-type: none"> • Switch to List View or • Switch to Gantt View
Switch List View Formats	The Package Browser has a separate version of the Navigator toolbar, through which you can change the Package being investigated and, in 'List View', the content shown.

	<p>In 'List View', the Package Browser has two formats that influence the use of other options on the display:</p> <ul style="list-style-type: none"> • User Defined format, initially a flat list, where you can define how the element information is grouped on the screen using the value-grouping band below the toolbar • Hierarchy format, where the elements are already organized into their Package and element hierarchies in the display (the value-grouping band is disabled) <p>To set the format, click on the  icon in the toolbar and select (for Hierarchy format) or deselect (for User Defined format) the 'Show Element Hierarchy' option.</p>
Change Standard View display	<p>It is possible to reorganize the information in the Package Browser in a number of ways:</p> <ul style="list-style-type: none"> • In User Defined format, sort the items by any column value in ascending or descending order, by clicking on the column header; initially the elements are listed in numerical order (if level numbering is turned on in the Browser window) or alphabetical order within type • Change the sequence of columns by dragging column headers left or right • In Hierarchy format, the 'Name' column is always on the left; you cannot move any other column into that position, although you can re-arrange the sequence of the rest of the columns <p>Because of this, if you group or sort information in User Defined format and switch to Hierarchy format your information structure is altered, and it is not restored when you switch back to User Defined format</p>
Show Elements in a Child Package	<p>Double-click on the child Package in the list to re-focus the display, showing the contents of that Package only.</p>
Display Element Properties	<p>Double-click on the element line to display the element 'Properties' dialog, or press Ctrl+Enter.</p> <p>If the Properties window is open, click on any element to make it the focus of the Properties window.</p>
Select Items	<p>Select:</p> <ul style="list-style-type: none"> • An element by clicking on it • A specific value by clicking twice on it (not double-clicking); either the value becomes directly editable (overtyping or selecting from drop-down) or the 'Properties' dialog displays in which you can edit the value • Several individual elements by holding Ctrl as you click on them • A range of elements by holding Shift as you click on the first and last in the range
Add new items to the Package	<p>Click on a listed element and press Ctrl+N or the Insert key, or right-click and select the 'Add New Element' option. The 'New Element' dialog displays; complete the fields and click on the Create button.</p> <ul style="list-style-type: none"> • In Model Hierarchy format, the new element is inserted as a sibling of the selected element, in its parent Package • In User Defined format, the new element is added to the root Package selected for display in the Package Browser
Add a child element to the selected element	<p>Click on the selected element and press Ctrl+Shift+N.</p> <p>The 'New Element' dialog displays; complete the fields and click on the Create button.</p>

	<ul style="list-style-type: none"> • In Model Hierarchy format, the new element is inserted as a child of the selected element • In User Defined format, the new element is added to the root Package selected for display in the Package Browser
Add elements to the Package Browser	<p>Drag the required elements from anywhere in the Browser window. The element is listed in the Package Browser, and moved into the target Package in the Browser window.</p> <p>You can also drag elements from the Package Browser into a Package in the Browser window, in either List view or Gantt view.</p>
Add elements to a diagram from the Package Browser	<p>In either List view or Gantt view, you can drag one or more elements from the Package Browser onto a diagram to immediately create an instance of each element on the diagram (and in the Browser window for the diagram's parent Package).</p> <p>Click each element (pressing Ctrl or Shift for multiple selections) to select it before dragging it onto the diagram.</p> <p>One advantage of dragging elements from the Gantt view is that it provides the additional filter on task or resource, so that you can isolate elements to be copied to a diagram or Package specific to a task or resource.</p>
Delete elements from the list	<p>Select the item and press Ctrl+D. This deletes the element from all diagrams and from the model itself.</p> <p>In Model Hierarchy format, you cannot delete a parent element until all its child elements have been removed or deleted.</p>
Include each element's notes (documentation)	<p>Notes are shown underneath the element.</p> <p>To add or edit notes, click on the item and press Ctrl+Shift+Space to transfer control to the Notes window, in which you create or edit the note text.</p> <p>Alternatively, right-click on the element line and select the 'Edit Notes' option.</p>
Further Work	<p>You can do further work on the Package Browser using the toolbar and context menu options.</p>

List Header

In your work on your project you might use any of a number of 'listing' reports in which information is organized in several columns. Such reports include the:

- Package Browser
- Specification Manager
- Diagram List
- Model Search
- Model Mail
- Discuss & Review window
- Features window
- 'Find Toolbox Item' dialog in the Diagram Toolbox
- 'Testing Details' and 'Maintenance Details' tabs of the QA Reports view
- The Project Gantt View
- The Project Tools window

In these reports, you can quickly and easily reorganize the sequence and combination of columns to present the information in the most appropriate format to suit your needs, and filter the data according to the values of the text strings displayed in the column fields.

Reorganize layout of display

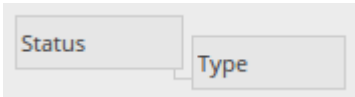
Tool	Description
Value Grouping	<p>For most reports, if the Package Browser or Diagram List does not have the 'Show Element Hierarchy' option selected, you can organize the reported data according to the value of one or more of the column categories, as identified in the 'Group Box' above the column headings. If the 'Group Box' is not already displayed, right-click on the column headings and select the 'Enable Group Box' option.</p> <p>You might organize the data by 'Type', and within each 'Type' by 'Name'; if you then click on any other column heading, the data within this grouping is further sorted with the values of the selected column (for example, 'Created') in ascending or descending order.</p> <p>To set up the value grouping, drag the column heading representing the primary grouping (such as 'Author') into the 'Group Box'.</p> <p>Now drag the column heading for the next level of grouping (such as 'Status') to the right of the first heading; the two heading titles display as connected blocks, as shown:</p>  <p>You can, if required, add further levels of grouping by dragging other column headings onto the hierarchy (such as 'Created'), and restructure the order by dragging existing or additional headings into the level you want them to hold.</p> <p>For example, you could make 'Type' the secondary grouping by dragging it to the right of 'Author', or drop 'Status' between 'Author' and 'Type'.</p> <p>To remove a grouping level, drag the appropriate column heading out of the sequence and below the View header; any subordinate groupings move up a level.</p>

Filter Bar	<p>The Filter Bar displays underneath the column headings; you can hide or show it using the 'Toggle Filter Bar' context menu option on the column headings.</p> <p>The Filter Bar consists of a row of fields, one field per column; as you type a value into one of these fields, the item lists are automatically filtered to show entries with a value in the corresponding column that contain the text string in the field.</p> <p>For example:</p> <ul style="list-style-type: none">• If you type the letter 'F' in the Filter Bar field under the 'Author' column, the results immediately reduce to entries for which the letter 'F' occurs anywhere in the name (Fred, Fitzgibbon, Rufus, Wolf)• If you then go on to type 'Fi', the results immediately reduce again to entries for which the combination 'fi' appears in the name (Fitzgibbon, Amalfi) <p>For reports and displays that identify the percentage completion of a task or piece of work, you can specify a percentage value or a range to display items that match that value. In the Filter Bar, in the field under the '%Completed or Complete' field, type:</p> <ul style="list-style-type: none">• <x to display items less than x percent complete; for example, <30 (all items less than 30 percent complete, but not those exactly 30 percent complete)• >x to display items more than x percent complete; for example, >30 (all items more than 30 percent complete, but not those exactly 30 percent complete)• x to display items exactly x percent complete; for example, 30 (all items exactly 30 percent complete)• -x to display items exactly x percent complete and less than that; for example, -30 (all items less than 30 percent complete and those exactly 30 percent complete)• x- to display items exactly x percent complete and more than that; for example, + 30 (all items more than 30 percent complete and those exactly 30 percent complete)• x-y to display items between x-1 percent complete and y+1 percent complete; for example 30-45 (all items between 30 and 45 percent complete, including those exactly 30 percent and 45 percent complete)
------------	---

Package Browser Options

In building and managing your model you can use the Package Browser as a workbench to perform many operations, such as reorganizing the Package structure, adding new Packages and elements, and generating reports on the Package contents. You can also modify the display in a number of ways.

To perform all of these operations, you select options from the drop-down menu available through the  icon on the Package Browser toolbar or through the context menu.

Access

Toolbar	Package Browser List View toolbar : 
Context Menu	Right-click on Package Browser List View

Menu Options

Option	Action
Add New	Add a new element to the Package. The 'New Element' dialog displays. Shortcut: Ctrl+N
Edit Notes	Display the Notes window, to add or edit notes for the selected element. The cursor is positioned at the start of the text entry area of the window. Shortcut: Ctrl+Shift+Space
Print	Print the current contents of the Package Browser. The 'Print' dialog displays, on which you specify the print job.
Generate Report	Display the 'Generate Documentation' dialog, to create one document report on the selected element(s). You can apply the full facilities of this dialog to tailor the report to your requirements.
Show Nested Package Content	Toggle the display between: <ul style="list-style-type: none"> • Including child Packages and their contents in the list, and • Showing only the first-level contents of the selected diagram or Package
Show Element Hierarchy	Toggle the display between: <ul style="list-style-type: none"> • Hierarchy format and • User-Defined, value-grouping format
Show Filter Bar	Display or hide the Filter Bar fields underneath the column headings, in any of which you can type a text string to filter the data in the corresponding column to

	show only data containing the typed string.
Show Group Bar	Display or hide the Group Bar (drag a column header here to group by that column).
Note Options	Display a short menu from which you can select to: <ul style="list-style-type: none"> • Hide the contents of the Notes compartment of each element • Display the first few words as a preview, or • Display the full text of each note

Context Menu Options

Right-click on an item in the list of elements and Packages.

Option	Description
Specialize	Select this option to access a submenu of enabled Technologies within the system (for example, ArcGIS or TOGAF), each of which provides options for performing technology-specific operations on the elements.
Collaborate	Select this option to display a short menu of sub-options to exchange electronic notes on the selected element with team colleagues, in the form of Reviews, Discussions and, if User Security is enabled, Chats and Model Mail messages, as well as the option to monitor Discussions on the element.
Switch to Gantt View	If in Standard (or List) View format, switch the display to Gantt View format.
Properties	Display the 'Properties' dialog for the selected element.
Edit Notes	Add or edit notes on the element, in the Notes window. Shortcut: Ctrl+Shift+Space
Linked Document	Create (or edit) a Linked Document. (Corporate, Unified and Ultimate Editions.) Shortcut: Ctrl+Alt+D
Add New Element	The 'New Element' dialog displays, through which you create an element of any type (after setting the appropriate toolset).
Find in Diagrams	Display: <ul style="list-style-type: none"> • The diagram that uses the element, or • If the element is used in multiple diagrams, the 'Element Usage' dialog, which lists the diagrams that contain the element
Find In Project Browser	Highlight the selected element in the Browser window.
Bookmark Item	Bookmark the element. When the element is displayed on a diagram, it has an inverted red triangle or Del symbol above it.

Documentation	<p>Generate a document report; you have two options:</p> <ul style="list-style-type: none"> • Generate a separate report on each selected object in the report • Generate one report on all selected objects <p>In either case, the 'Generate Documentation' dialog displays. If you have selected to generate separate reports, the 'Generate Documentation' dialog displays separately for each report in turn.</p> <p>You also have the option to print the Package Browser list itself.</p>
Sort Contents	<p>In Hierarchy format, synchronize the list with the Browser window hierarchy, to ensure that all element and Package hierarchies and sequences are - if necessary - updated.</p> <p>Normally changes are updated automatically, but there can be delays if changes are made outside the Package Browser.</p>
Reload	Reload the list of elements to refresh the order and content with any recent changes.
Add Tag Value Column	Add a column to show the values for a selected Tagged Value, for each element in the list (see <i>Add Tagged Value Column</i> later in this topic).
Columns Layout	<p>Preserve, apply or delete a profile of the column layout of the Package Browser display. A layout consists of the number of columns and (where the workstation screen layout permits) the column widths.</p> <p>When you mouse-over this option, a submenu displays:</p> <ul style="list-style-type: none"> • Load Columns Layout - displays a dialog in which you select to apply the default layout (all possible columns) or one that you have previously saved; click on the OK button to apply the layout • Save Columns Layout - displays a dialog in which you specify the name under which to save the layout - you can replace an existing layout by clicking on the drop-down list and selecting the name, or save as a new layout by typing a new name • Delete Columns Layout - displays a dialog in which you specify the layout profile to delete; when you click on the OK button, the profile is deleted (and cannot be retrieved again) but if that profile was in use when it was deleted, the layout persists until it is specifically changed, even if you close and re-open the Package Browser
Print	<p>Print the contents of the Package Browser.</p> <p>The 'Print' dialog displays, on which you specify the print job.</p>
Delete Selected	<p>Delete the selected element from the Package Browser.</p> <p>A confirmatory prompt displays; click on the Yes button.</p>

Add Tagged Value Column

If you want to show the value that any element in the list has for a particular tag, you can add a read-only column for the tag. There are two ways in which to do this; the first method is simple and direct, whilst the second method enables you to search for and select a specific tag that might be set for a number of elements.

Method	Action

1	Open the 'Tag' tab of the Properties window for the element and drag the tag onto the Package Browser; a new column is added for each tag you drag onto the list.
2	<p>Either:</p> <ul style="list-style-type: none"> • Right-click on the element in the Package Browser or Diagram List, or • Right-click on the column headings <p>Then select the 'Add Tag Value Column' option; the 'Add Tag Value Column' dialog displays.</p> <p>Either type the tag name into the 'Tagged Value' field, or select one of the two options:</p> <ul style="list-style-type: none"> • Global Tagged Values - populates the 'Tagged Value' drop-down list with all global Tagged Values in the project; this enables you to select a Tagged Value that is applicable to a large number of elements • Tagged Values from the selected element - populates the 'Tagged Value' drop-down list with the Tagged Values defined for the selected element (as listed on the 'Tags' tab of the Properties window for that element); this enables you to filter the initial selection to a specific set of tags <p>When you have selected the required tag, click on the OK button to insert a column for that tag into the Package Browser or Diagram List header.</p>



Notes

- In the Corporate, Unified and Ultimate Editions of Enterprise Architect, if Auditing is turned on and the Package Browser is open, you can view a history of changes to any selected element or connector, in the 'Audit History' tab of the System Output window (if Security is enabled, you must have at least 'Audit View' permissions to display the audit history)

The Portals Bar

The Portals provide a high level, logical grouping of Enterprise Architect's tools and facilities, to form an entry point into specific features that you might need to apply. They provide access to common tools, custom searches, window layouts and Perspectives. For example, if you want to run searches for particular information in the model, or access the windows that are appropriate to a particular set of actions, you can select a Portal to identify and provide access to those facilities. This makes it easier to set up a work environment within the system, and carry out your tasks in a smooth sequence.

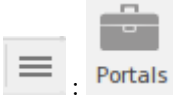
Access

Ribbon	Explore > Portals > <select Portal> Start > Application > Design > Portals : <Portal> button <Portal>
Keyboard Shortcuts	Shift+Alt+P
Other	 Navigator Toolbar :  : 

The Portals window

The Portals window displays on either the left- or right-hand side of the Enterprise Architect work area. It contains the currently-selected Portal and, under the title bar, a Portal selection button for changing the selected Portal.

Once the Portals window is displayed, it remains visible until you specifically select to hide it, or to auto hide it as a tab on the side of the display, using the Portals window context menu options (see the *Portals Window Context Menu* table later in this topic).

Portals

The system currently provides eight Portals, each consisting of a collapsible hierarchy of option groups and options. If a Portal is too long to display the entire contents at once, a scroll button displays at the top and/or bottom of the Portal. Click on these buttons to scroll the Portal contents up or down (or use the scroll wheel on your mouse, or the keyboard arrow keys).



Portal	Description
Recent Places	Provides links to recently viewed diagrams, documents and files. Links are grouped into these categories: <ul style="list-style-type: none"> • Current Diagrams • Recent Diagrams • Documents • Recent Files

Workspaces	<p>Provides links to the system-provided workspaces that you might use to lay out the Enterprise Architect work area, and to any workspaces that you have created yourself. The categories provided are:</p> <ul style="list-style-type: none"> • Customized ('My Workspaces') • Core • Design • Software • Simulation • Construction • BABOK
Perspectives	<p>Provides a wide range of model Patterns from which you can generate model structures for particular areas of work. The Patterns are organized into groups within Perspectives, and presented for selection through the 'Model Builder' dialog.</p>
Windows	<p>Provides links to the Enterprise Architect windows that you might use. The windows are grouped under the areas of:</p> <ul style="list-style-type: none"> • Exploring the model • Properties • Diagrams • Specialized Tools • Trace • Collaborate • Test • Task • Maintenance • Templates
Extend	<p>Lists the MDG Technologies currently active in your model - such as ArcGIS or NIEM - and for each one provides links to the facilities for working with those technologies within Enterprise Architect.</p>
Execute	<p>Provides a wide range of options that help you to:</p> <ul style="list-style-type: none"> • Perform Execution Analysis on your model - building and running the Analyzer scripts • Record, Profile, Debug and Simulate the execution of your modeled application • Access various windows that display specific aspects of debugging and simulating an application • Create and edit code for your application
Guidebook	<p>Provides links to the library of Enterprise Architect User Guides in PDF format. The Portal initially displays with ten categories of document, each of which can be expanded to a list of the PDF documents in that category.</p>
Learning	<p>Provides links to either the web version of the <i>Enterprise Architect User Guide</i>, or the locally-installed Help if you have downloaded that. The Portal also provides links to a number of useful web pages on the Sparx Systems website, such as the Resources, Tutorials, Webinars and Video Demos pages.</p>

Portals Window Context Menu

Right-click on the Portals window title bar to display the context menu. You can select the options in this table:



Portal	Description
Dock Left	Docks the Portals window on the left hand side of the work area.
Dock Right	Docks the Portals window on the right hand side of the work area.
Auto Hide	Condenses the Portals window to a tab on the edge of the work area. Mouse-over the tab to re-open the Portals window, move the cursor off the window to return it to a tab.
Hide	Hides - and effectively closes - the Portals window. To re-open the window, select the appropriate option under the 'Explore > Portals' ribbon icon or the appropriate icon on the Start page.
Auto Collapse Groups	Automatically collapses the currently-selected group of options when you expand another group.
<list of portals>	If you right-click anywhere in the Portals window other than the window title, the list of Portals displays. Click on a Portal name to change to that portal in the window.

Recent Places Portal

Provides links to recently viewed diagrams, documents and files. Clicking the link will re-open the selected item in the appropriate window. Links are grouped into these categories:

- Current Diagrams
- Recent Diagrams
- Documents
- Recent Files

Access

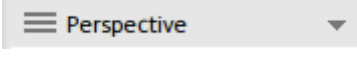

Ribbon	Explore > Portals Recent Places
Keyboard Shortcuts	Shift+Alt+P :  Perspective Recent Places
Other	Navigator Toolbar :  :  Portals :  Perspective Recent Places

Workspaces Portal

Provides links to the system-provided workspaces that you might use to lay out the Enterprise Architect work area, and to any workspaces that you have created yourself. The categories provided are:

- Customised ('My Workspaces')
- Core
- Design
- Software
- Simulation
- Construction
- BABOK

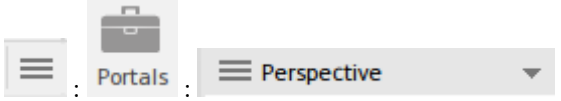
Access

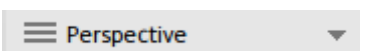
Ribbon	Explore > Portals > Workspaces
Keyboard Shortcuts	Shift+Alt+P :  Workspaces
Other	 Navigator Toolbar :  :  : 

Facilities

Category	Options
My Workspaces	This section provides the Workspaces that you have customized for your particular use on the 'My Workspaces' tab of the 'Workspace Layouts' dialog.
Core	The options in this category apply some of the basic workspaces to your work area. These include: <ul style="list-style-type: none"> • Basic Diagramming • Collaborate • Core Modeling • Default • Explore • Wide View
Design	The options in this category apply some of the model design workspaces to your work area. These include: <ul style="list-style-type: none"> • Database Modeling

	<ul style="list-style-type: none"> • Gap Analysis • Requirements • Schema Design • Trace by Matrix • Use Case Modeling
Software	<p>The options in this category apply some of the software development workspaces to your work area. These include:</p> <ul style="list-style-type: none"> • Code Editing • Debug • Profile • Record • Software Engineering • Testpoints • XSLT Debugging
Simulation	<p>The options in this category apply some of the simulation workspaces to your work area. These include:</p> <ul style="list-style-type: none"> • BPSim • DMN-Sim • Simulation • SysML-Sim
Construction	<p>The options in this category apply some of the project construction workspaces to your work area. These include:</p> <ul style="list-style-type: none"> • Change • Maintenance • Resource Management • Support • Task Management • Testing • Work Items
BABOK Guide	<p>The 'BABOK Reader' option applies the BABOK workspace to your work area.</p>



Perspectives Portal

The Perspective Portal provides a number of work Perspectives grouped by general work area. Each Perspective filters the modeling windows and dialogs to present only the modeling Patterns you might use in the work defined by the Perspective. When you select a Perspective the Model Builder dialog displays, providing the model templates that you might use to initially create a model supporting the type of work.

For example, if you select the 'Construction > Kanban' Perspective the Model Builder dialog presents three Kanban Patterns for one-stage, two-stage and three-stage workflows. As you open or refresh other windows, such as the 'Diagram Builder' tab page of the 'Model Builder' dialog, the objects you can initially select are filtered to provide - in this example - only Patterns for developing Kanban diagrams.

The Perspectives you can select from the Portal, the Patterns they provide, and the facilities for managing Perspectives are described in the *Model Perspectives* Help topic.

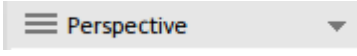

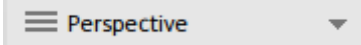

Access

Ribbon	Explore > Portals Perspectives
Keyboard Shortcuts	Shift+Alt+P :  Perspective
Other	Navigator Toolbar :  :  :  Perspective

Windows Portal

Provides links to the Enterprise Architect windows you use to navigate through, develop and manage your models.

Access

Ribbon	Explore > Portals > Windows
Keyboard Shortcuts	Shift+Alt+P :  Perspective Window
Other	Navigator Toolbar :  :  Portals :  Perspective Window

Facilities

Type	Facilities
Explore	<p>Provides links to display the:</p> <ul style="list-style-type: none"> • Project } tabs of the Browser • Context } window • Resources } • 'Details' tab of the Inspector window • Navigator • Model Search • File Search • System Output window
Properties	<p>Provides access to these facilities:</p> <ul style="list-style-type: none"> • Properties window main tab • Notes dialog • 'Tags' tab of the Properties window • Summary screen • Document window • Features dialog • Requirements window
Diagram	<p>Provides access to these facilities:</p> <ul style="list-style-type: none"> • Filters and Layers • Pan and Zoom window • Diagram Layout tools





Specialized Tools	<p>Provides access to these facilities:</p> <ul style="list-style-type: none"> • Specification Manager • Scenario Builder • Constraints, through the Responsibility window • Decision Table Editor • Database Builder • Schema Composer
Trace	<p>Provides access to these facilities:</p> <ul style="list-style-type: none"> • The Traceability window • Relationships window • Relationship Matrix • Gap Analysis Matrix
Collaborate	<p>Provides access to these team communication facilities:</p> <ul style="list-style-type: none"> • Finding All Reviews • Finding All Discussions • Conducting Reviews • Conducting Discussions • Model Mail • Calendar • Chat • Model Library
Test	<p>Provides the facilities to create and review Tests of all types supported by Enterprise Architect.</p>
Task	<p>Provides access to these facilities:</p> <ul style="list-style-type: none"> • Project Gantt Chart • Personal Gantt Chart • Resource List
Maintenance	<p>Provides access to the facilities for recording and managing:</p> <ul style="list-style-type: none"> • Changes • Defects • Issues • Tasks • Events • Decisions • Effort • Risks • Metrics
Templates	<p>Provides access to the facilities for maintaining:</p> <ul style="list-style-type: none"> • Code Engineering Templates • DDL Templates

	<ul style="list-style-type: none">• Document Templates
--	--

Extend Portal

The Extend Portal lists the MDG Technologies currently active in your model, and for each one provides links to the facilities for working with those technologies within Enterprise Architect.

Access

Ribbon	Explore > Portals > Extend
Keyboard Shortcuts	Shift+Alt+P :  Extend
Other	Navigator Toolbar :  :  :  Extend

Facilities





The options provided in this Portal depend on what Add-Ins and MDG Technologies are loaded and active for the model, and what operations are supported between the technologies and Enterprise Architect.

Execute Portal

The Execute Portal provides links to the facilities of the system that help you to:

- Perform Execution Analysis on your model - building and running the Analyzer scripts
- Record, Profile, Debug and Simulate the execution of your modeled application
- Access various windows that display specific aspects of debugging an application
- Run a number of searches for information on recent Simulations

Access

Ribbon	Explore > Portals > Execute
Keyboard Shortcuts	Shift+Alt+P :  Perspective > Execute
Other	Navigator Toolbar :  :  :  Perspective > Execute

Facilities

Category	Options
Execution Analyzer	<p>These options provide the facilities to create and execute scripts for building, running and testing an application. Select:</p> <ul style="list-style-type: none"> • Edit Build Scripts - to display the Execution Analyzer window, from which you can select a Build Script to edit • Open Source File - to display the 'Open Source File' browser from which you select a source file to view, and then display the file content in the Code Editor • Merge - to run the Merge script associated with the selected Package • Build - to build the selected Package according to the active Build Script • Deploy - to run the deployment script associated with the selected Package • Run - to run the executable script associated with the selected Package • Test - to run the testing script associated with the selected Package
Simulator	<p>The options in this section open a number of windows that you might use in a Simulation session. Select:</p> <ul style="list-style-type: none"> • Simulator to open the Simulation window • Triggers and Events to open the Simulation Events window • Breakpoints - to open the Breakpoints & Markers window • Local Variables - to open the Locals window • Call Stack - to open the Call Stack window • BPSim to open the Configure BPSim window

	<ul style="list-style-type: none"> • SysMLSim to open the Configure SysML Simulation window
Simulation	<p>The options in this section help you to quickly control a simulation process. Select:</p> <ul style="list-style-type: none"> • Start Simulation - to start debugging • Step - to step over the next line of code after a break • Step In - to step into a function call in the code • Step Out - to step out of a function call • Pause - to pause simulation • Stop - to stop the simulation altogether
Debugger	<p>The options in this section open a number of windows that you might use in a debugging session. Select:</p> <ul style="list-style-type: none"> • Debugger - to open the Debug window • Breakpoints - to open the Breakpoints & Markers window • Call Stack - to open the Call Stack window • Local Variables - to open the Locals window • Memory - to open the Memory Viewer window • Modules - to open the Modules window • Watches - to open the Watches window • Object Workbench - to display the 'Object Workbench' dialog • Debugging Perspective - to display the set of debug windows, dialogs, toolbars and menus that you might use in a debugging session
Debug	<p>The options in this section help you to quickly debug a running process or application (through a debug script). Select:</p> <ul style="list-style-type: none"> • Debug Run - to start debugging • Step - to step over the next line of code after a break • Step In - to step into a function call in the code • Step Out - to step out of a function call • Pause - to pause debugging • Stop - to stop the debugging session altogether
Record	<p>The options in this section help you to set up, start, record and analyze the execution of the application code developed from your model. Select:</p> <ul style="list-style-type: none"> • Recorder to open the Record & Analyze window • 'Apply Record Layout' - to open the windows and dialogs that you would use in performing Execution Analysis on your model • 'Start Recording' - to start a manual recording of the current thread during a debug session, managing it using the 'Step...' functions • 'Stop Recording' - to stop the current recording session • 'Auto Record Thread' - to begin recording and not stop until either the program ends, you stop the debugger or you click on the 'Stop' icon • 'Toggle Display of Execution Point' - to toggle between highlighting the execution point and not doing so • 'Create Sequence Diagram' - to generate a Sequence diagram from the recording trace
Profile	<p>The two options in this section are to quickly set up a Profiling session on your</p>

	<p>application. Select:</p> <ul style="list-style-type: none">• Profiler - to open the Profiler window• Apply Profile Layout - to display all windows and dialogs that you might use in profiling the execution of your application
Code	<p>The options provided in this section help you to create, edit and debug code.</p> <ul style="list-style-type: none">• Scripting - displays the Scripting window for creating scripts within script groups• Source Code Editor - displays the Source Code Editor, which helps you to view, edit and maintain your source code directly inside Enterprise Architect• Language Grammars - displays the Grammar Editor for writing and editing a grammar for code imported in a new programming language• Search Files - displays the Find in Files window for searching the content of selected files, or using the Code Miner
Test	<ul style="list-style-type: none">• Testpoints to open the Testpoints window
XSLT	<ul style="list-style-type: none">• XSLT Editor/Debugger - displays both the XSLT Debugger screen and the System Output window at the XSLT Transformation tab, for converting an input document into XML or other document types using an XSLT Stylesheet; the transformation is modeled in an XML Transform diagram, from which you can debug and/or execute the stylesheet





Guidebook Portal

The Guidebook Portal provides access to a library of PDF documents held on the Sparx Systems website. These documents discuss specific areas of Enterprise Architect's functionality and use. The documents are grouped according to the area of work they support, namely:

- Basics
- Repository
- Modeling
- Domains
- Guides (for Business Analysis, Business Modeling and Enterprise Architecture)
- Project Management
- Publishing
- Simulation
- Execution
- Automation

To open a document, double-click on the document name.

Access





Ribbon	Explore > Portals > Guidebook
Keyboard Shortcuts	Shift+Alt+P :  Perspective > Guidebook
Other	Navigator Toolbar :  :  :  Perspective > Guidebook

Learning Portal

The Learning Portal provides links to a number of useful Help pages or other web pages on the Sparx Systems website, to present topical information quickly.

The options are organized in a sequence, giving very specific information on a narrow subject such as keyboard shortcuts through increasingly broad discussions of facilities, features and concepts.

Access

Ribbon	Explore > Portals > Learning
Keyboard Shortcuts	Shift+Alt+P :  Perspective > Learning
Other	Navigator Toolbar :  :  :  Perspective > Learning

Facilities

Category	Options
Quick Reference	The 'Quick Reference' option provides a set of Help topics that give immediate information on some of the collections of tools of Enterprise Architect, such as shortcut keys or the ribbons.
Help	The options in this group access the top-level topic from each chapter of the Help. Once you have displayed a top-level topic, you can select subordinate topics for more detailed information on a subject, or return to the Index to open a different chapter.
Special Topics	These topics describe specific features and facilities of Enterprise Architect, to provide a direct and focused discussion of a facility such as Kanban diagrams or Roadmaps.
Guides	These topics discuss broader subject areas and work concepts, such as Enterprise Architecture, Business Analysis and Business Modeling.
Webinars	Select the 'All Webinars' option to open the 'Webinar Registration' page of the Sparx Systems website, which: <ul style="list-style-type: none"> • Describes upcoming webinars (real-time seminars hosted via the internet) scheduled by Sparx Systems, and • Provides links to the registration form, for you to register your participation in a webinar
About	The options in this section provide access to a range of useful Sparx Systems web

	<p>pages, which contain information on and demonstrations of Enterprise Architect and other Sparx Systems facilities.</p> <ul style="list-style-type: none">• 'Tutorials' - to open the 'Tutorials' page of the Sparx Systems website, which provides tutorials on general UML modeling and doing work with Enterprise Architect• 'Resources' - to open the 'Help, Tutorials & White papers' page and the 'Resources' page of the Sparx Systems website, providing access to a wide range of Enterprise Architect and UML tutorials, demonstrations, examples, base files, Add-Ins and general information• 'MDG Technologies' - to open the 'MDG Products' page of the Sparx Systems website, which provides a brief description of, and the download links for, each supported MDG Add-In product for a selected edition of Enterprise Architect - select your installed edition from the drop-down list Enterprise Architect editions such as Unified and Ultimate will automatically register certain Add-In products; however these Add-Ins are not included in the default Enterprise Architect installation and must be downloaded separately• '3rd Party Extensions' - to open the 'Third Party Extensions' page of the Sparx Systems website, which provides listings of additional Enterprise Architect Add-Ins developed by partners and other members of the Enterprise Architect community• 'Newsletter' - to open the 'Newsletters' page of the Sparx Systems website, which provides links to view newsletters previously released by Sparx Systems, and to subscribe to receive future newsletters as they are released• 'Release History' - to open the 'Recent Features' page of the Sparx Systems website, which provides a full history of changes in the most recent builds of Enterprise Architect You can also open the release history and investigate the features of earlier releases of the system, going back to version 1.1.3, the very first commercial release
--	--

The System Output Window

The System Output window is used to display information generated by internal Enterprise Architect processes, or by Add-Ins and other third-party tools. The output from each type of operation is generally displayed on its own tab within the window. The System Output window can provide useful information during long-running processes and batch operations; through this window you can, for example:

- Validate information - many validation processes within Enterprise Architect write out their results to this window
- Review progress information during the launch of external processes
- Review command line output from Build and Test scripts
- Review the output of jobs executed from the Job Queue window
- Check parse errors generated during import of various types of files
- Check Audit information
- Re-dock the Model Search results into a System Output window tab for more convenient reference during various operations

For some processes, information can be displayed on the System Output window in a long line, wider than the window. You can display the hidden text by dragging the slider bar in the upper right of the window.

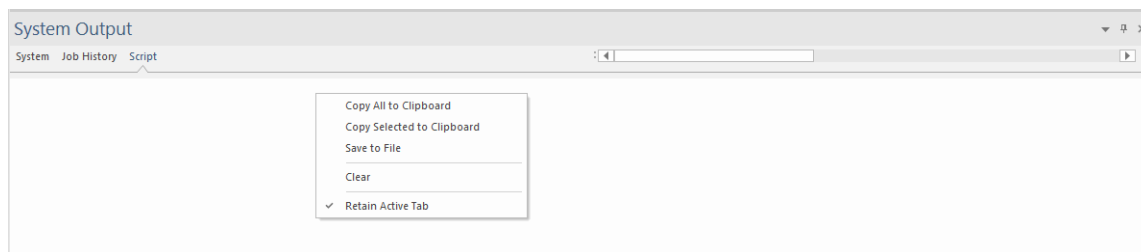

Access

Ribbon	Start > All Windows > Design > Explore > System
Keyboard Shortcuts	Ctrl+Shift+8 Alt+1 System

Options available on output data

Right-click on an item and select the appropriate context menu option to:

- Copy the selected item to the clipboard
- Copy all items to the clipboard
- Save the output to an external file
- Clear the output from the window
- Fix the currently-selected tab so that other processes do not switch the window to another tab (see *Notes*)
- Rollback selected 'Get All Latest' updates to a Version Controlled Package

You can also:

- Drag the selected items or text out of the System Output window and onto a diagram to quickly create a named

element

- Double-click on model validation errors or parsing errors to display the source of the error
- Switch between tabs to view different categories of information from different tools

Notes

- (Corporate, Unified and Ultimate Editions of Enterprise Architect, with Auditing turned on) the 'Audit History' tab of the System Output window shows a history of changes to any element or connector selected from the:
 - Audit View
 - Package Browser
 - Diagram List
 - Browser window, or
 - Current diagram
- When separate processes are functioning at the same time, more recent processes could switch the tab for an earlier process to the tab for whichever other process is outputting information, and displays and information for the earlier process might be lost; by selecting the 'Retain Active Tab' context menu option, you prevent the current System Output window tab from being switched out by any process other than you manually selecting a different tab

The Code Editors

Enterprise Architect provides a number of editors that you can use across the development environment to maintain scripts, code and templates. Each editor has its own features, but they are all based on a common Code Editor control.

You can have several code editors (or files within a code editor) open at the same time, as separate tabs in the Enterprise Architect central work area (the 'Diagram View'). You can also close the editors individually or all together, leaving views of other types (such as diagrams or Document reports) still open.

Code Editors

Editor	Detail
Shape Script Editor	When you create a Shape Script to alter the appearance of an element or connector through the use of a stereotype, you create and edit the script using the Shape Script Editor, which provides a number of facilities including Intelli-sense for Shape Script attributes and functions.
Code Generation Template Editor	You use the Code Generation Template Editor to create and edit templates that control the generation of code from your model elements. The facilities include Intelli-sense for a wide range of macros.
Transformation Template Editor	You use the Transformation Template Editor to create and edit templates that control the transformation of model structures from one domain to another (typically a generic domain to a code language specific domain).
Custom SQL Search Filter Editor	The Custom SQL Search Filter Editor is available through the Model Search facility, to define your own SQL searches for locating information in your model.
Database View Editor	The 'Database View editor' is available within the 'View definition' field of a database View element 'Properties' dialog. You create the View definition in SQL, using Intelli-sense for basic SQL keywords and functions.
HTML and CSS Style Editor	You use the HTML and CSS Style Editor to create web style templates from which to generate HTML reports. These templates incorporate a large number of HTML Template Fragments, which you edit to customize the reports for your specific purposes.
Source Code Viewer	You use the Source Code Viewer to both display and edit the source code files that you have generated or imported for an element. The Viewer/Editor is quite adaptable, and you can access it and use it in different ways for different types of source code file.
Script Editor	Enterprise Architect provides a flexible and easy to use scripting capability to create scripts in JavaScript, Microsoft JScript or VBScript for programmatically inspecting and/or modifying elements within the currently open model. You use the Script Editor to create and edit scripts, and to run, debug and stop an open script.

Keyboard Shortcuts

You can display the Enterprise Architect dialogs, windows and views, or initiate processes, using menu options and Toolbar icons. In many cases, you can also access these facilities by pressing individual keyboard keys or combinations of keys, as shortcuts. The tables in this topic show the default keyboard shortcut for each of the functions. You can also display the key combinations on the 'Help Keyboard' dialog (the Keyboard Accelerator Map).

The shortcuts described here are operations on the model. When a diagram is open, you can use special quick-keys that make navigating and editing the diagram simple and fast. These quick-keys are described in the *Diagram Shortcuts* Help topic.

Access

Ribbon	Start > Help > Help > Open Keyboard Accelerator Map
--------	---

Notes

- The 'Help Keyboard' dialog shows the functions that have shortcut keys; it does not list functions that have no shortcuts
- There are additional shortcuts using the keyboard and mouse in combination
- If necessary, you can change the keyboard shortcuts using the 'Keyboard' tab of the 'Customize' dialog

Opening Projects

Shortcut	Operation
Ctrl+N	Create an object of the same type as the current selection in the window or diagram. Otherwise, the 'New Project' dialog displays through which you can create a new Enterprise Architect (.qea, .eap or .feap) project.
Ctrl+O	Open an Enterprise Architect project.
Ctrl+Shift+F11	Reload the current project.

Adding Objects to the Project

Shortcut	Operation
Ctrl+Shift+M	Add a new model to the project, using the Model Builder.
Ctrl+Insert	Add a new diagram to a Package.

Ctrl+M	Add a new element to a Package.
Shift+F3 or Ctrl+click	Create a new element of the same type as the last, on the diagram.
Ctrl+Shift+F9	Add an attribute to an element.
Ctrl+Shift+F10	Add an operation to an element.
Ctrl+F11	Add other types of feature to an element.
Insert key	Insert a new feature after the current selection.

Locating Information

Shortcut	Operation
Ctrl+F, Ctrl+Alt+A	Search for items in the project (search in the model).
Ctrl+Shift+F	Opens the Find in Files window at the 'Find File' tab, which you use as a File System Explorer to quickly locate specific files.
Ctrl+Shift+Alt+F	Search files for data names and structures.
Alt+G	Locate the selected element in the Browser window.
Shift+Alt+G	Locate a selected object in the Browser window.
Ctrl+Alt+G	Locates, in the Browser window, the classifier for an object or instance, or the call operation for an Action element.
Ctrl+U	Locate diagrams in which the element is used.

Copying and Pasting

Shortcut	Operation
Ctrl+C	Copy text, or element ID for pasting an element on a diagram as a link.
Ctrl+Shift+C	Copy an element, multiple elements or a Package plus any underlying structure to the clipboard for duplication in a target Package.
Ctrl+X	Cut the selected text.
Ctrl+V	Paste text.

Viewing Information in Windows

Shortcut	Operation
Alt+1	Displays the Design Window Selector, which provides access to the windows for locating, creating and working on objects on the model, including within diagrams.
Alt+2	Displays the Properties quick-access window, which provides access to the element Properties, Features, and Responsibility windows and dialogs, and a number of other tools for working on objects within an element.
Alt+3	Displays the Collaborate quick-access window, which provides access to the Collaboration facilities such as Discussions, Reviews, Journal entries, personal conversations and information concerning the overall model.
Alt+4	Displays the Execute quick access panel, which provides access to the Simulation, Source Code, Visual Analysis and Process Execution windows and tabs.
Alt+5	Displays the Construct quick-access panel, which gives access to tools for managing resources, changes, testing and project metrics.
Alt+6	Displays the Publish quick access panel, which provides access to facilities for generating static and dynamic reports, exchanging models in part or entire, and keeping the model data accurate and up to date.
Alt+7	Displays the Workspace quick access panel, which provides access to the defined workspaces for Design and Construction, Software and Simulation and User Layouts.
Alt+8	Displays the Debug window.
Alt+9	Opens the Relationship Matrix.
Alt+0	Displays the Feature Matrix for the currently-selected element.
Alt+Enter	Displays the element 'Properties' dialog at the 'General' tab.
Alt+\	Moves focus to the Diagram View from a docked window.
Ctrl+Space	Displays the Quick Notes window for the selected object.
Ctrl+1	Displays the Browser window.
Ctrl+Enter or Ctrl+2	Displays the Properties window.
Ctrl+3	Opens the Notes window.
Ctrl+4	Displays the Responsibility window.
Ctrl+5	Displays the Features window (defaulted to the 'Attributes' tab).

Ctrl+6	Displays the Summary window for the selected object (not for Views, Model Packages, diagrams, instances or connectors).
Ctrl+7	Opens the Traceability window.
Ctrl+8	Displays the Maintenance window (defaulted to the 'Changes' tab).
Ctrl+9	Display the Discuss & Review window at the 'Discussions' tab.
Ctrl+0	Displays the Specification Manager view.
Enter key	In the 'Project' tab of the Browser window, displays the context menu for the object. In the 'Details' tab of the Inspector window, displays the 'Properties' dialog for the object, feature or property, or the equivalent 'Details' dialog.
Ctrl+F4	Closes the current window.
Ctrl+Shift+1	Displays the Portals window.
Ctrl+Shift+2	Opens the element Relationships window.
Ctrl+Shift+3	Displays the Diagram Toolbox.
Ctrl+Shift+4	Displays the Pan and Zoom window.
Ctrl+Shift+5	Displays the Database Builder.
Ctrl+Shift+6	Displays the Schema Composer.
Ctrl+Shift+7	Opens the Resource Allocation window.
Ctrl+Shift+8	Opens the System Output window.
Ctrl+Shift+9	Displays the Scripting window.
Ctrl+Shift+0	Displays the work area full screen, and restore full screen to partitioned, multi-window.
Ctrl+Shift+F4	Auto hides the current window.
Ctrl+Alt+R	Opens the Package Browser (Package Contents).
Ctrl+Alt+U	In the Browser Window, opens the Library window.
F9	Displays the Features window at the 'Attributes' tab.
F10	Displays the Features window at the 'Operations' tab.
Shift+Enter	Displays the special properties of certain types of object or, if there are no special properties, displays the 'Properties' dialog. If used in the 'Details' tab of the Inspector window, the selected item is displayed in a window.

Generating Documentation

Shortcut	Operation
F8	Opens the 'Generate Documentation' dialog for creating documents and reports.
Shift+F8	Opens the 'Publish as HTML' dialog for generating a web report in HTML.
Ctrl+Shift+F8	Generates a 'Diagrams Only' report.

Deleting Objects from the Project

Shortcut	Operation
Ctrl+Delete	Deletes the selected element(s) from the model (from the Browser window and any diagram in which the element occurs).
Ctrl+Shift+Delete	Deletes the selected feature from the model.

Checking Spelling

Shortcut	Operation
Ctrl+Shift+F7	Spell checks the current Package.
Ctrl+F7	Spell checks the model.

Performing Code Engineering

Shortcut	Operation
Ctrl+Shift+P	Edit code generation templates.
Alt+7	Open the Source Code window.
Ctrl+Alt+Y	Opens a source directory.

Ctrl+Alt+O	Opens a source file.
Ctrl+Shift+U	Imports a source directory.
Ctrl+Alt+K	Generates Package source code.
Ctrl+Alt+M	Synchronizes Package contents.
F11	Generates code on a selected element.
F7	Synchronizes the current element.
Shift+F11	Batch generates selected elements.
Ctrl+R	Batch synchronizes selected elements.
Ctrl+E or F12	Displays source code in the code editor.
Ctrl+Alt+H	Edit Transformation templates.
Ctrl+H or Ctrl+Alt+F	Transforms selected elements.
Ctrl+Shift+H	Transforms the current Package
Ctrl+Shift+I	Indents the cursor/line one tab setting in the code editor.

Exchanging Data

Shortcut	Operation
Ctrl+Alt+I	Import a Package from XML.
Ctrl+Alt+E	Export a Package to XML.
Ctrl+Alt+C	Import and export to data CSV files.

Performing Visual Execution Analysis

Shortcut	Operation
Ctrl+Shift+J	Create a Workbench Instance of a Class.
Shift+F12	Manage Analyzer Scripts on the Execution Analyzer window.
Ctrl+Shift+F12	Create a Build Script.

Ctrl+Alt+N	Create a Run Script.
Ctrl+Alt+T	Create a Test Script.
Ctrl+Shift+Alt+F12	Create a Deployment script.
Alt+8	Open the Debug window.
F6	Start a Debug session.
Shift+F6	Step Into a function call.
Alt+F6	Step Over a function call.
Ctrl+F6	Step Out of a function call.
Ctrl+Alt+F6	Stop the debug session.

Other Operations

Shortcut	Operation
Shift+F9	Check project data integrity.
Ctrl+Alt+B	Manage Baselines.
Ctrl+Alt+D	Create a Linked Document on an element.
Ctrl+Alt+P	Configure Package Control.
Ctrl+Alt+V	Validate the current Package.
Ctrl+Shift+`	Switches focus to the active view from any window. For example, if you are reviewing something in the Specification Manager and open a dialog on an item, using this key combination returns focus to the Specification Manager.
Ctrl+Shift+B	Manage structural (embedded) elements.
Ctrl+Shift+E or F4	Configure an element's default appearance.
Ctrl+Shift+L	Open a 'Lock <item>' dialog for the selected Package, diagram or element.
Ctrl+Shift+O	Override inherited features.
Ctrl+Shift+W	Select an alternative image for an element.
Ctrl+Shift+Y	Specify which element features are visible on a diagram.

Ctrl+F9	Configure system options.
Ctrl+I	Set an element's parent or implement interface(s).
Ctrl+J	Set cross references to other elements and diagrams.
Ctrl+L	Locate and set the classifier for an object. Also loads a controlled Package from its XML file.
Ctrl+S	Saves changes, mainly in diagrams, but also saves a controlled Package to its XML file and saves and reverse engineers a generated code file to the model
Ctrl+Z	Reverses changes to the content of diagrams, Notes, documents and templates.
F2	Edit the selected property value.
F5	Refresh the selected Package in the Browser window.

Keyboard-Mouse Shortcuts

When you work on an aspect of your model within a diagram, there are a number of operations you can perform quickly using a combination of keyboard keys and the computer mouse.

Keyboard/mouse combinations

Action	Shortcut
Create an element of the same type as was last created on the diagram.	Ctrl+click
Make a duplicate of an existing diagram element.	Ctrl+Shift+hold left mouse button and drag to a new location on the diagram
Display the element 'Properties' dialog for the element shown in the scenario 'Context References' tab.	Ctrl+click
Select a number of individual objects for an operation.	Ctrl+click each object
Select a range of objects for an operation.	Shift+click on the first and last object in the range
Move the selected elements along the horizontal axis or vertical axis.	Shift+hold left mouse button and drag
Create a bend in and change the direction of the connector line.	Shift+hold left mouse button and drag
Add or remove a bend-point from a connector.	Ctrl+click or Shift+click on the connector at the point to add or remove
Move elements in a section of the diagram ('Sweeper') in any direction, including diagonally.	Alt+hold left mouse button and drag
Zoom in to or zoom out of the diagram.	Ctrl+ mouse scroll wheel
Scroll the diagram horizontally.	Shift+mouse scroll wheel

Diagram Shortcuts

When you have a diagram open, you can use a set of single or combination keyboard keys to move between, select and operate on the elements and connectors within the diagram.

Selecting and Marking Elements

Quick Key	Operation
Enter, comma (,) or period (.)	When no element is currently selected, select the element nearest the top left corner of the diagram or of the section of diagram in view.
. (period)	When an element is selected, change selection to the nearest child element closest to the top left of the selected parent element, on the diagram.
, (comma)	When an element is selected, change selection to the parent element of the selected child element, on the diagram
Arrow keys	Select the next element on the diagram above, below, to the left or to the right of the current element; when moving left or right, the selection tends to be upwards rather than downwards.
S	Keep an element selected as you move to another element (using the keyboard arrow keys), so that you can select multiple elements using the keyboard.
Q, F (element name) or F2 (property)	If no element property is selected, highlight the element name for in-place editing. If you have selected an element property, enable it for in-place editing.
F	Select the first editable feature of the item in focus. This is generally the element name but if you select a Tagged Value that has multiple system-defined values (such as the SearchName tag) you can cycle through the list of values to obtain the correct one.
Shift+Space	Bookmark the current element with a red marker.
/	Toggle selection between the current (source) element and its connector.

Inserting Objects, and Cutting and Pasting

Quick Key	Operation
Ctrl+V or Shift+Insert	Paste element(s) from the clipboard as links to the original element(s). The 'Paste <element name>' dialog displays; simply click on the OK button to paste the element.
Ctrl+Shift+V	Paste a diagram element as a duplicate copy of the original element. The 'Paste as New' dialog displays.

Insert or Spacebar	Displays the 'Toolbox Shortcut' menu, from which you can select to create and add an element of one of a wide range of types.
Ctrl+Shift+Insert	Paste an element into the diagram as a metafile image held on the clipboard.
F3	Create a new connector of the same type as the last.
W	Add a way-point to the current connector. (This does not act on every line style.)
Ctrl+Shift+I	Hide or show selected connectors.

Positioning Elements

Quick Key	Operation
Alt	<p>Press or tap this key when moving a child element in its parent element on the diagram, to toggle between:</p> <ul style="list-style-type: none"> • Confining the child element to the parent and • Allowing the child element to be dragged outside the borders of the parent element, thus breaking the child-parent relationship <p>Under Linux or Windows VM, do not <i>hold</i> the Alt key down, as this is linked to other behaviors.</p>
Alt+Z	Automatically size selected elements.
Alt+-	Space elements evenly, horizontally.
Alt+=	Space elements evenly, vertically.
Shift+arrow keys	Move elements by small increments.
Ctrl+arrow keys	Resize a selected element by small increments.
Ctrl+Alt+Down	Align the bottom edges of selected elements.
Ctrl+Alt+Up	Align the top edges of selected elements.
Ctrl+Alt+Left	Align the left boundaries of selected elements.
Ctrl+Alt+Right	Align the right boundaries of selected elements.

Saving and Undoing Changes

Quick Key	Operation
-----------	-----------

Ctrl+Z	Undo a change.
Ctrl+Y	Redo an undone change.
Ctrl+S	Save changes to a diagram.
Ctrl+T	Save an image to file.
Ctrl+B	Save an image to the clipboard.

Deletions

Quick Key	Operation
Delete key or Ctrl+D	Delete selected element(s) in a diagram, but not from the model.
Ctrl+Delete	Delete selected element(s) in the diagram from the diagram and from the model.

Displaying Details in Other Windows

Quick Key	Operation
N	Open and/or shift focus to the Notes window.
P	Open and/or shift focus to the Properties window.
R	Open and/or shift focus to the Relationships window.
E	Display the Responsibility window
V	Display the Properties window
Z	If the Inline Specification Manager window is open, set focus to that window.
O	When you have selected an operation, open the Features window at the 'Operations' tab.
A	When you have selected an attribute, open the Features window at the 'Attributes' tab.
G	Display the 'Generate Code' dialog for the selected element, to generate code from it.
Y	Synchronize the code generated from the selected element with the element content.

M	Display the 'New Element' dialog to create a new element.
Ctrl+Shift+N	View the Pan and Zoom window.

Displaying Portals Windows

Quick Key	Operation
1	Display the Recent Places portal
2	Display the Workspaces portal
3	Display the Perspectives portal
4	Display the Windows portal
5	Display the Extend portal
6	Display the Execute portal
7	Display the Guidebook portal
8	Display the Learning portal

Printing a Diagram

Quick Key	Operation
Ctrl+P	Print the active diagram.

Status Bar

The Status bar displays at the bottom of the Enterprise Architect work area. It shows information on the current operation and certain key settings, and provides a 'zoom bar' for adjusting the scale of the diagrams you view.

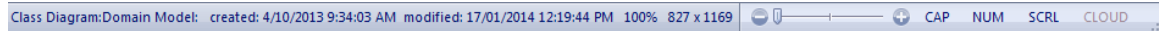

You can hide the Status bar itself by selecting the 'Hide Status Bar' option on the 'Window Behavior' page of the 'Preferences' dialog ('Start > Appearance > Preferences > Preferences > General > Window Behavior').

You can also hide sections of the information that the Status Bar shows by right-clicking on it and de-selecting any or all of the options:

- <current perspective> (to hide the name of the currently selected Perspective)
- Zoom Slider
- Status Indicators

Status Bar Sections

Section	Information
Object Type/Name	Shows the type and name of the currently-selected diagram, or of the currently selected element in the diagram, or the status of the currently-displayed Model Search.
Creation data	Shows the date and time at which the current diagram was created and last modified, the percentage zoom of the current display, and the normal page size of the diagram.
Element/Feature Name	Shows the name of the currently-selected element, attribute or operation.
Position and Size	Shows the coordinates of the top left corner of the selected element, and the width and height of the element.
<perspective name>	Shows the name of the currently-selective Perspective or Perspective Set.
Zoom Control	Allows a zoom to be applied to all diagrams, regardless of existing zoom levels and without impacting other users. Values range from 100% to 150%.
Status Indicators	Indicates the status of the Caps Lock, Num Lock and Scrl Lock keyboard keys, and the Connect to Cloud facility (bold indicates 'in use', pale indicates 'off').
Display Maximized	A triangle in the bottom right corner indicates that the screen is not maximized; you can drag the screen corner to increase the size of the window.

Notes

- The zoom facility has the same function as the 'Scale view by' field on the 'Diagram Appearance' page of the 'Preferences' dialog; changes in the 'zoomed' display scale of a diagram update this field and are applied to any other diagrams that you open

Legacy Toolbars

Enterprise Architect provides a set of toolbars containing convenient shortcuts to a wide range of common functions that you can perform on your project as a whole or on the individual modeling units.

The toolbars can be displayed in the toolbar banner at the top of the work area, or you can float them over a particular area of the application; this is useful when you are using a certain set of functions a lot in a particular area.

You can also dock toolbars to the edge of the Enterprise Architect work area by dragging them by the title bar and placing them against the appropriate edge.

Available toolbars

- Default Tools Toolbar
- Project Tools Toolbar
- Diagram Toolbar
- Element Toolbar
- Connector Toolbar
- Code Engineering Toolbar
- Simulate Toolbar
- Build Toolbar
- Record Toolbar
- Debug Toolbar
- Collaborate Toolbar
- Custom Draw Style Toolbar
- Publish Toolbar

Each toolbar has a  icon at the right-hand end, which can be enabled or hidden using the 'Window Behavior' tab of the Preferences window. If you click on this drop-down arrow, the 'Add or Remove Buttons' option displays. Select this option to show a context menu listing the toolbars that are displayed on the same line as the current toolbar, and an option to customize toolbars - both your own and the system-provided toolbars.

If you select one of the toolbars identified on the context menu, the icons available through that toolbar are listed. Click on the checkbox against each icon as necessary to hide or show it in the toolbar.

If you select the 'Customize' option, the 'Customize' dialog displays at the 'Commands' tab, where you can start associating icons with commands to be added to Toolbars on the 'Toolbars' tab.

There are two other bars that provide functions you can apply in different contexts; these are the:

- Navigator Toolbar to help you locate and move to sections of the model, and
- Status Bar to provide information on currently-selected objects and on important system settings

Many of the dockable windows in the system also have their own embedded Toolbars below the window name; for example, the Notes Toolbar on the Notes window, and the Browser window toolbar.

Quick Access Toolbar

The Quick Access Toolbar (QAT)  is a handy, customizable toolbar that provides quick access to a set of frequently used commands. By default, the QAT contains buttons for Full Screen view and the Workspace Quick Access panel. Users can also add their own frequently-used commands to this set.

Access

You can find the Quick Access Toolbar at the top left corner of the Enterprise Architect application window. You can also move it to an alternative location below the menu ribbon, so that it is closer to the main view.

QAT Menu

Clicking on the QAT's drop down button, , displays the QAT menu.

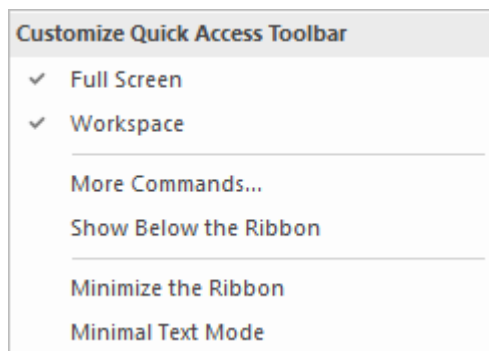

The menu commands are described in this table:

Command	Description
Full Screen	Maximize the main window and most other windows.
Workspace	Show/Hide the Workspace button in the QAT. (The Workspace button is used to display the Workspace Quick Access panel.)
More Commands	Display the customization dialog, where you can add more commands to the toolbar.
Show Below the Ribbon	Show the Quick Access Toolbar below the ribbon, placing it closer to the main view.
Minimize the Ribbon	Minimize the ribbons and completely hide them from view.
Minimal Text Mode	Hide the text under large icons in the ribbon.

Customizing the Quick Access Toolbar

There are two ways to add commands to the Quick Access Toolbar.

In the Ribbon, right-click on the command that you want to add to the QAT. From the pop-up menu, choose 'Add to Quick Access Toolbar'.

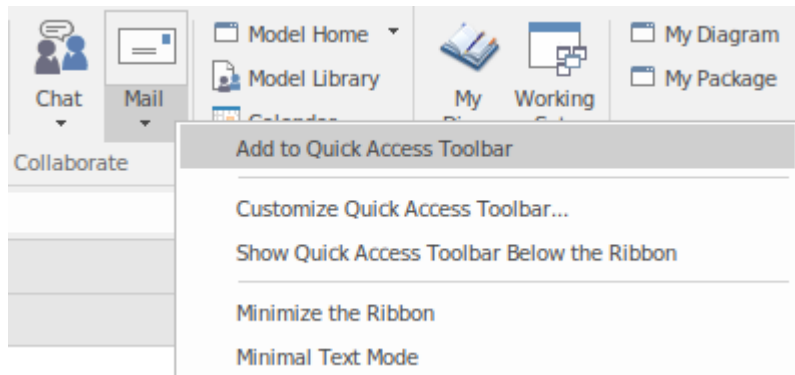

Alternatively, you can add commands using these steps:

- Click on the QAT's drop-down button , and select 'More Commands'
- Use the pop-up window to add or remove commands from the QAT

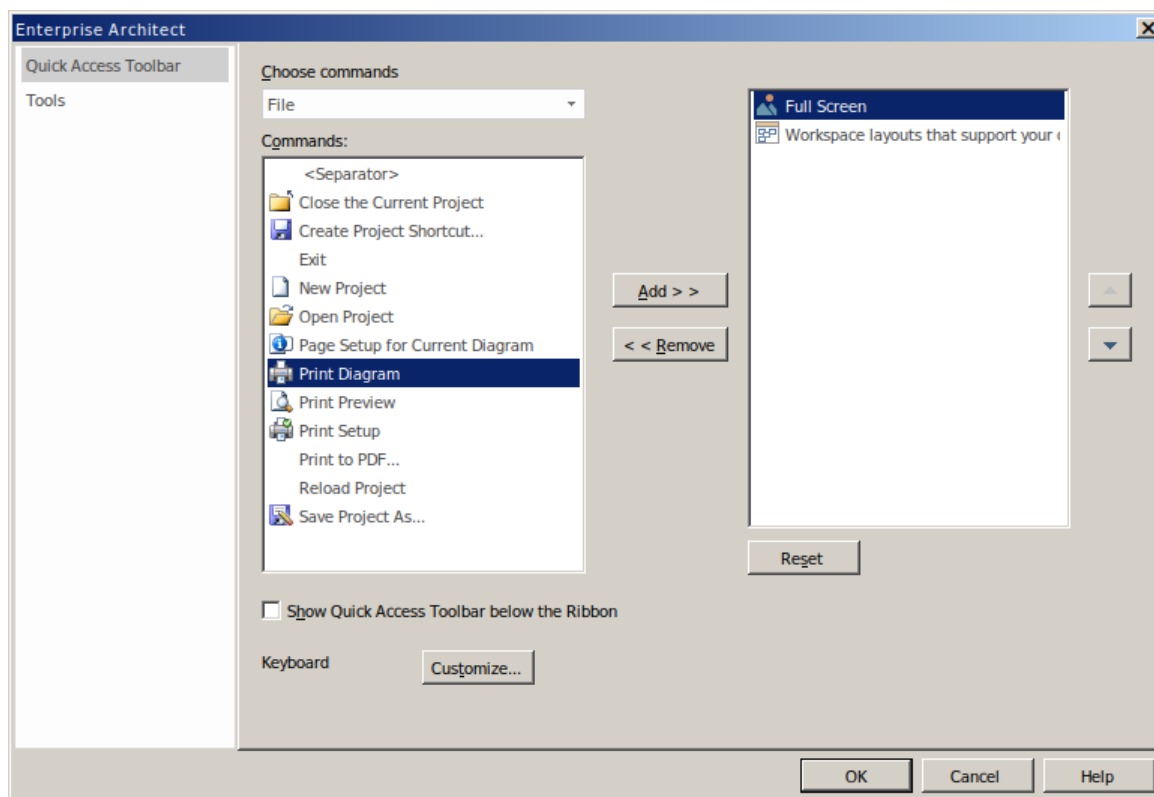

Using the Quick Access Toolbar

Once a command has been added to the QAT, it is readily accessible regardless of the menu ribbon that is currently displayed.

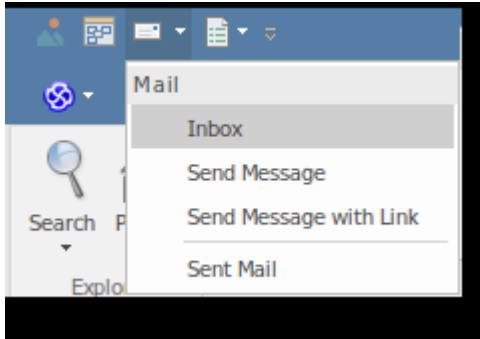

Default Tools Toolbar

The Default Tools toolbar provides instant access to the most commonly used tools in Enterprise Architect, including file management, printing and technology facilities.



Access

Ribbon	Explore > Portals Show Toolbar Default Tools
--------	--

Default Tools Options

Icon/Option	Action
New Project	Click on this icon to create a new Enterprise Architect project (as a .EAP, .EAPX or .FEAP file). Shortcut: Ctrl+N
Open Project	Click on this icon to open an existing project. Shortcut: Ctrl+O
Save Current Diagram	Click on this icon to save changes to the current diagram. Shortcut: Ctrl+S
Cut	Click on this icon to cut the selected element(s) from the diagram and copy them to the Enterprise Architect clipboard. Shortcut: Ctrl+X
Copy	Click on this icon to copy the selected element(s) from the diagram to the Enterprise Architect clipboard. Shortcut: Ctrl+C
Paste	Click on this icon to paste elements from the Enterprise Architect clipboard as a reference on the current diagram. Shortcut: Shift+Insert Ctrl+V
Undo	Click on this icon to undo the last action. Shortcut: Ctrl+Z
Redo	Click on this icon to redo the last undone action. Shortcut: Ctrl+Y

Print Preview	Click on this icon to display the current diagram as it will appear when printed.
Page Setup for Current Diagram	Click on this icon to configure print settings for the current diagram.
Print Diagram	Click on this icon to print the current diagram. Shortcut: Ctrl+P
Package Browser	Click on this icon to display the content of the current Package as a list of editable elements.
Project Search	Click on this icon to display the Find in Project window, to define, manage and run model searches. Shortcut: Ctrl+Alt+A
Technology List	Click on the down-arrow and select the active technology, to provide the appropriate sets of Toolbox pages and the diagram Space Bar context element menu options.
Help Contents	Click on this icon to access the Enterprise Architect Help. Shortcut: F1

Notes

- The Cut button and Copy button are only enabled when an item is selected on the current diagram
- You can move this toolbar to any dockable position; it retains that position in subsequent sessions
- You can hide or show the toolbar by clicking on the 'Explore > Portals > Show Toolbar > Default Tools' ribbon option

Project Toolbar

The Project toolbar provides tools for performing routine tasks such as creating Packages, diagrams and elements, searching the model and generating documentation.



Access

Ribbon	Explore > Portals Show Toolbar Project Tools
--------	--

Project Toolbar Options

Icon/Option	Action
Reload Project	Click on this option to close and reload the current project, to bring in changes made by other users sharing the project. Shortcut: Ctrl+Shift+F11
New Diagram	Click on this option to create a new diagram under the currently selected Package, in the Browser window. Shortcut: Ctrl+Insert
New Package	Click on this option to create a new child Package under the currently selected Package, in the Browser window. Shortcut: Ctrl+W -- --
New Element	Click on this option to create a new model element under the currently selected Package or element, in the Browser window. Shortcut: Ctrl+M
Find in Project Browser	Click on this option to run a simple search within the Browser window.
Find in Project	Click on this option to search the entire project or the selected Package using pre-defined and customized searches. Shortcut: Ctrl+F
Generate Documentation	Click on this option to define and generate Document reports on the currently-selected Package. Shortcut: F8
Project Issues	Click on this option to display the 'Project Issues' dialog to review and create project issues.

Project Glossary	Click on this option to display the 'Glossary' dialog to review and create glossary terms.
Set Options	Click on this option to display the 'Preferences' dialog, through which you can personalize project display and behavior options for your own login to the project. Shortcut: Ctrl+F9

Notes

- You can move this toolbar to any dockable position; it retains that position in subsequent sessions
- You can hide or show the toolbar by selecting the 'Explore > Portals > Show Toolbar > Project Tools' ribbon option

Diagram Toolbar

The Diagram toolbar provides tools to lay out and improve the appearance of diagrams, including zoom controls to better manage large diagrams and quickly identify key areas of interest.



Access

Ribbon	Explore > Portals Show Toolbar Diagram
--------	--

Diagram Toolbar Options

Icon/Option	Action
Align Left	Click on this option to align the left edges of the selected elements. Shortcut: Ctrl+Alt+Left Arrow
Align Right	Click on this option to align the right edges of the selected elements. Shortcut: Ctrl+Alt+Right Arrow
Align Tops	Click on this option to align the top edges of the selected elements. Shortcut: Ctrl+Alt+Up Arrow
Align Bottoms	Click on this option to align the bottom edges of the selected elements. Shortcut: Ctrl+Alt+Down Arrow
Bring to Top	Click on this option to bring the selected elements to the top of the Z order, in front of other elements on the diagram.
Send to Back	Click on this option to move the selected elements to the bottom of the Z order, behind other elements on the diagram.
Previous diagram	Click on this option to display the previous open diagram. Shortcut: Alt+Left Arrow
Next Diagram	Click on this option to display the next open diagram. Shortcut: Alt+Right Arrow
Home Diagram	Click on this option to display the default Model Diagram (or default User Diagram) if one has been defined.
Zoom In	Click on this option to zoom into (magnify) the diagram by 10 percent.

Zoom Out	Click on this option to zoom out of (shrink) the diagram by 10 percent.
Fit to View	Click on this option to adjust the diagram size to fit within the Diagram View screen.
Size View to Page	Click on this option to adjust the diagram size to fit within the page margins shown on the screen.
Zoom to 100%	Click on this option to display the diagram content at 100% of default size, regardless of the Diagram View screen size.
Layout Diagram	(Not applicable to Behavioral diagrams) Click on this option to automatically layout the diagram in the Digraph layout format.
Diagram Properties	Click on this option to display the 'Properties' dialog, on which you can adjust the diagram display and behavior properties.
Paste Appearance	Click on this option to apply to the selected element a set of appearance style settings as defined for an element in the 'Default Appearance' dialog and loaded into the Painter.
Delete Selected	Click on this option to delete the selected element(s) from the diagram. Shortcut: Ctrl+D

Notes

- Any actions that result in a change in diagram content and appearance (including Zoom) are saved as changes to the diagram
- The Diagram toolbar can be docked to any main window edge or floated freely in a convenient location for quick access
- You can move this toolbar to any dockable position and it retains that position in subsequent sessions
- You can hide or show the toolbar by clicking on the 'Explore > Portals > Show Toolbar > Diagram' ribbon option

Element Toolbar

The Element toolbar provides a number of options for performing common operations on a selected element, such as viewing the element's properties, operations or attributes. You can also use it to specify the visibility of the element's features and compartments, and to lock that element.



Access

Ribbon	Explore > Portals > Show Toolbar > Element
--------	--

Element Toolbar Options

Icon/Option	Action
Edit Properties	Click on this option to display the element 'Properties' dialog, through which you can view and edit the properties of the selected element. Shortcut: Alt+Enter
Set Parent	Click on this option to display the 'Set Parents and Interfaces' dialog, through which you can set the parent or implement interfaces for the selected element. Shortcut: Ctrl+I
Operations	Click on this option to display the 'Operations' page of the Features window, through which you can create and edit operations for the selected element. Shortcut: F10
Attributes	Click on this option to display the 'Attributes' dialog, through which you can create and edit attributes for the selected element. Shortcut: F9
Show Features	Click on this option to display the 'Compartment Visibility' dialog, through which you can specify which compartments and information to display for the selected element. Shortcut: Ctrl+Shift+Y
Set Runstate/Initialization	Click on this option to display the 'Override Attribute Initializers' dialog, through which you can set the element run state, attribute initializers or - for Parts - property value. Shortcut: Ctrl+Shift+R
Find Element Usage	Click on this option to find all other diagrams in which the selected element is used: <ul style="list-style-type: none"> If the element is not used in any other diagram, there is no further action

	<ul style="list-style-type: none">If the element is included in other diagrams, the 'Element Usage' dialog displays, listing those diagrams, and you can choose which diagram to explore Shortcut: Ctrl+U
Find in Project Browser	Click on this option to highlight the selected element in the Browser window. Shortcut: Alt+G
Configure References	Click on this option to display the 'Custom References' dialog, on which you can view the properties of other elements and diagrams in the model to which the selected element has custom cross-references. Shortcut: Ctrl+J
Lock Element	Click on this option to apply or release a lock on the selected element. The element is then blocked against or made available for editing, respectively, depending on which locking policy your system is operating under.
Add Tagged Value	Click on this option to display the 'Tagged Value' dialog, through which you can add a Tagged Value to the selected element(s). Shortcut: Ctrl+2 > Tags

Notes

- You can move this toolbar to any dockable position and it retains that position in subsequent sessions
- You can hide or show the toolbar by selecting the 'Explore > Portals > Show Toolbar > Element' ribbon option

Connector Toolbar

The (Current) Connector toolbar provides a number of options for quickly modifying the properties, style and direction of a selected connector, showing and hiding the connector and/or its labels, and pinning each end of the connector.



Access

Ribbon	Explore > Portals > Show Toolbar > Connector
--------	--

Current Connector Toolbar Options

Icon/Option	Action
Connector Properties	Click on this option to display the '<connector type> Properties' dialog, on which you can view and edit the properties of the selected connector. Shortcut: Enter key
Connector Style	Click on the drop-down arrow and select the appropriate connector line style from the list. The options are: <ul style="list-style-type: none"> • Direct Route • Auto Routing • Custom Routing Shortcut: Ctrl+Shift+D Ctrl+Shift+A Ctrl+Shift+C
Attach Note or Constraint	Click on this option to display the 'Link Relations' dialog, which you use to attach a note or constraint to the selected connector and to any other existing connectors in the current diagram. Double-click on the Note element to display the 'Notes' dialog on which to type in the text.
Show or Hide Connector Labels	Click on this option to display the 'Label Visibility' dialog, which you use to specify which of the eight possible label positions around the selected connector are to be displayed.
Show and Hide Relationships	Click on this option to display the 'Set Visible Relations' dialog, through which you can show or hide each of the relationships between elements within the current diagram. Shortcut: Ctrl+Shift+I
Reverse Direction	Click on this option to simply reverse the direction of the selected connector.

Pin Connector Ends	<p>Click on the down-arrow to select the end of the selected connector to pin to the source and/or target elements. The pinned end cannot be dragged off the point on the element border to which it has been fixed.</p> <p>Some connector line styles (such as the Tree styles) are not compatible with pinning the connector ends; if a pinned connector is changed to one of these styles, the connector ends will be unpinned.</p>
--------------------	--

Notes

- You can move this toolbar to any dockable position and it retains that position in subsequent sessions
- You can hide or show the toolbar by clicking on the 'Explore > Portals > Show Toolbar > Connector' ribbon option

Code Engineering Toolbar

The Code Generation (Engineering) toolbar provides options to import, generate, synchronize and open source code. Some of these options display convenient menus to quickly set, for example, the default language and default database type for the project.

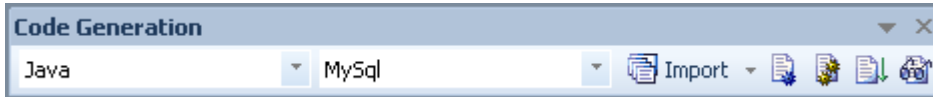

Access

Ribbon	Explore > Portals > Show Toolbar > Code Engineering
--------	---

Code Generation Toolbar Options

Icon/Option	Action
Default Code Language	Click on the drop-down arrow and click on a coding language in the list, to set that language as the default applied to all newly created Class elements.
Default Database Type	Click on the drop-down arrow and click on a database type in the list, to set that database type as the default applied to all newly created database elements.
Import	<p>Click on the drop-down arrow to locate and select source files to import for reverse engineering code into new Class and Interface elements in the current diagram.</p> <p>Firstly, click on a coding language in the drop-down list to identify the file types to locate; this selection overrides the project's default language for this particular import.</p> <p>When you have selected a language, a browser dialog displays through which you browse for the file location and select from files with the extensions appropriate to the coding language you selected.</p> <p>When you click on a file, the system immediately imports it and generates elements from the file, in the current diagram. The progress of the reverse engineering is shown on a 'Progress' dialog; click on the Close button when the process is complete.</p>
Generate Source Code	<p>Click on this option to generate source code for the currently selected single Class element, through the 'Generate Code' dialog.</p> <p>Shortcut: F11</p>
(Batch) Generate Source Code	<p>Click on this option to batch-generate source code for multiple selected Class elements.</p> <p>A 'Progress' dialog displays and, if no target file is specified in the element, a prompt for the location of a file to generate the code into.</p> <p>Shortcut: Shift+F11</p>

Synchronize Element with Source	Click on this option to synchronize the selected Class element with its associated source code. The synchronization completes as a background task. Shortcut: F7
Open Source Code	Click on this option to open the source code of the selected Class, in the default code editor. The source code must have been generated, and the selected element must be a Class. Otherwise no action is taken. Shortcut: F12

Notes

- You can move this toolbar to any dockable position and it retains that position in subsequent sessions
- You can hide or show the toolbar by selecting the 'Explore > Portals > Show Toolbar > Code Engineering' ribbon option

Simulate Toolbar

The Simulate toolbar provides access to control options for executing a simulation of a behavioral model's processing through a model diagram. These options enable you to start, pause, stop and step in, out, and over the simulation, and set the type and speed of the simulation.

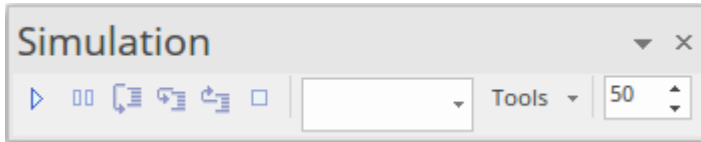

Access

Ribbon	Explore > Portals > Show Toolbar > Simulate
--------	---

Simulate Toolbar Options

Icon	Action
Simulate	Start the Simulator for the current diagram or, if the current diagram cannot be simulated, run the Simulation using the activated Simulation script.
Pause-Resume	Pause the simulation.
Step In/Over/Out	When the Simulation is paused, step over, step in and step out to control the Simulator's execution at the required step in the model Simulation.
Stop Simulation	Stop the simulation.
Set Type	Click on the drop-down arrow and select the type of simulation to run: <ul style="list-style-type: none"> 'Interpreted' - Perform dynamic execution of a simulation (Corporate, Unified and Ultimate Editions) 'Manual' - Step through a simulation manually (the only option available in the Professional Edition) 'Executable' - Select when running the simulation on an Executable StateMachine
Select Tool	Click on the drop-down arrow and select from a menu of options for performing specific operations on the simulation script and output, such as Build, Run, Generate and View Breakpoints.
Set Rate	Vary the execution rate of the Simulation, between 0% and 100%; at: <ul style="list-style-type: none"> 100%, the Simulation executes at the fastest possible rate 0% the Simulator breaks execution at every statement

Notes

- The Simulate Toolbar is also found as the embedded toolbar in the Simulation window

Build Toolbar

The Build toolbar provides access to tools for building program source code. From this toolbar you can:

- Build the currently active application
- Run the compiled application
- Run your Test and Deployment scripts

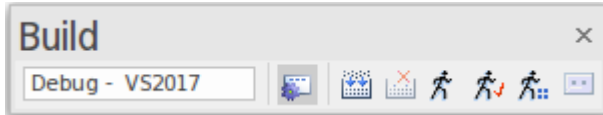

Access

Ribbon	Explore > Portals > Show Toolbar > Build
--------	--

Build Toolbar Options

Icon/Option	Action
Active Analyzer Script	Display the name of the currently active analyzer script.
Execution Analyzer	Click on this icon to display the Execution Analyzer window, which you use to manage the Analyzer scripts for your model. Shortcut: Shift+F12
Build Current Package	Click on this icon to execute the Build script for the selected Package. Shortcut: Ctrl+Shift+F12
Cancel Build	Click on this icon to cancel execution of the Build script currently in progress.
Run Executable	Click on this icon to execute the Run script for the selected Package. Shortcut: Ctrl+Alt+N
Run Test Script	Click on this icon to execute the Test script for the selected Package. Shortcut: Ctrl+Alt+T
Run Deployment Script	Click on this icon to execute the Deploy script for the selected Package. Shortcut: Ctrl+Shift+Alt+F12
Run Merge Script	Click on this icon to execute the Merge script for the selected Package. Shortcut: Ctrl+Alt+M

Notes

- The toolbar can be docked to any main window edge or floated freely in a convenient location for quick access
- You can move this toolbar to any dockable position and it retains that position in subsequent sessions
- You can hide or show the toolbar by clicking on the 'Explore > Portals > Show Toolbar > Build' ribbon option

Record & Analyze Toolbar

The Record & Analyze toolbar provides access to tools for recording the execution of program source code. From this toolbar you can:

- Begin manual or automation recording of the currently active application
- Step through manual execution
- Generate Sequence diagrams from a recording session

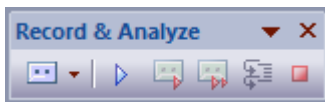

Access

Ribbon	Explore > Portals Show Toolbar Record
--------	---

Record & Analyze Toolbar Options

Icon/Option	Action
Recorder Command List	Click on the drop-down arrow to show a menu of commands for recording the execution of Analyzer scripts.
Recording	Click on this icon to begin or resume recording of the current program.
Manual Record	Click on this icon to manually step-record the current thread.
Auto Record Selected Thread	Click on this icon to auto-record an execution trace for the current thread.
Step Through	Click on this icon to step into a function, record the function call in the History window, and step back out. The option is enabled for manual recording only. Shortcut: Alt+;
Stop Recording	Click on this icon to end the recording of program execution.
Synchronize Model with Source Code	Display the 'Synchronize Model' dialog through which you can synchronize the model with the code files generated during a Record Profile operation.

Notes

- The toolbar can be docked to any main window edge or floated freely in a convenient location for quick access

- You can move this toolbar to any dockable position and it retains that position in subsequent sessions
- You can hide or show the toolbar by clicking on the 'Explore > Portals > Show Toolbar > Record' ribbon option

Debug Toolbar

The Debug toolbar provides access to tools for debugging program source code. From this toolbar you can:

- Attach to running processes
- Open a number of debugger windows
- Run, pause or terminate program execution
- Step over, step into or step out of program statements



Access

Ribbon	Explore > Portals Show Toolbar Debug
--------	--

Debug Toolbar Options

Icon/Option	Action
Drop-down Command List	Click on the drop-down arrow and select options from the menu for attaching to a running process and accessing a range of debugging windows.
Debug	Click on this option to begin or continue execution of the current program. Shortcut: F6
Pause-Resume	Click on this option to pause or resume execution of the current program.
Step Over	Click on this option to step over the next statement in the program. Shortcut: Alt+F6
Step In	Click on this option to step into the next function call in the program. Shortcut: Shift+F6
Step Out	Click on this option to step out of the current function call. Shortcut: Ctrl+F6
Debug Stop	Click on this option to stop debugging the current program. Shortcut: Ctrl+Alt+F6

Notes

- The toolbar can be docked to any main window edge or floated freely in a convenient location for quick access
- You can move this toolbar to any dockable position and it retains that position in subsequent sessions
- You can hide or show the toolbar by clicking on the 'Explore > Portals > Show Toolbar > Debug' ribbon option

Collaborate Toolbar

The Collaborate Toolbar provides options to swiftly access and switch between the communication and fact recording facilities of Enterprise Architect, such as Model Mail, Discussions and the Diary.

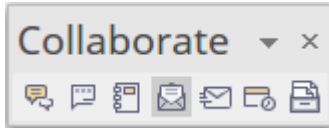

Access

Ribbon	Explore > Portals Show Toolbar Collaborate
--------	--

Collaborate Toolbar Options

Icon	Action
Show Discussions	Opens the Discuss & Review window at the 'Discuss' tab, for you to start or respond to a discussion on the currently-selected element or diagram.
Chat	Opens the Chat & Mail window at the 'Chat' tab, for you to participate in an exchange of brief comments on any point, with members of one of the defined user security groups.
Diary	Opens the Chat & Mail window at the 'Diary' tab, to maintain a daily diary in which you can type all kinds of ideas, comments, notes, suggestions, events, to-do lists and other reminders of what you have done or intend to do within the model.
Model Mail	Opens the 'Mail' tab of the Chat & Mail window, which provides you with the ability to send, receive and respond to emails within the project team under your User Security ID, either as an individual user or as a member of a group that has a shared mail inbox.
Send Message	Opens the 'Model Message' dialog directly; you use this dialog to create, address and send a Model Mail message.
Calendar	Opens the Project Calendar, defaulted to today's date, on which you can check for scheduled meetings and reminders of events, and add items for today or any day in the future.
Model Library	Opens the Model Library, which you use to review and add to a hierarchically-structured repository of comments, reports, reviews and documents on any structure, feature or aspect of the project or of other, related projects.

Notes

- The toolbar can be docked to any main window edge or floated freely in a convenient location for quick access
- You can move this toolbar to any dockable position and it retains that position in subsequent sessions
- You can hide or show the toolbar by clicking on the 'Explore > Portals > Show Toolbar > Collaborate' ribbon option

Custom Draw Style Toolbar

The Custom Draw Style Toolbar provides access to a range of facilities for applying a simple style of drawing to segments of your model, rather than the formalized styles of the notations such as UML, ArchiMate and SysML. These facilities are essentially the shape and position options provided by the full Custom Style Format toolbar displayed on a diagram when Custom Styles are enabled.

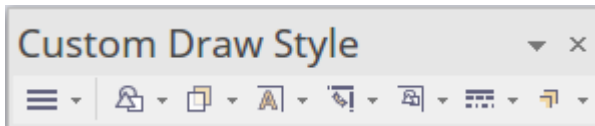

The icons are highlighted on the Toolbar when at least one element is selected in a diagram.

Access

Ribbon	Explore > Portals Show Toolbar Custom Draw Style
--------	--

Custom Draw Style Toolbar Options

Icon	Action
Hamburger	This icon offers the choice of enabling Custom Styles for all elements on the diagram or for just those that are currently selected.
Shapes	<p>This icon changes the shape of the selected element. In the drop-down menu, click on the appropriate shape option to render the element as a:</p> <ul style="list-style-type: none"> • Rectangle (the default) • Rounded-corner rectangle • Ellipse (which you can drag into the shape of a circle) • Diamond • Triangle or • Polygon, with a submenu to define the shape as having 5, 6, 7, 8, 9 or 10 sides <p>You can also select the 'Non' option to restore the element to its native shape and format.</p>
Transparency	<p>This icon sets the selected element shape to be fully transparent (so that the diagram background and any overlapped elements show through) or at one of various degrees of opacity that overshadow the overlapped elements. If you set 100% opacity, the element fill is solid and totally hides the background and any overlapped elements.</p> <p>Click on the drop-down arrow and select from:</p> <ul style="list-style-type: none"> • 100% (fully opaque) • 75% • 50% • 25% and

	<ul style="list-style-type: none"> • 0% (fully transparent)
Text Position	<p>This icon sets the position of the element name, stereotype and notes within the element border. You can position the text at nine points within the element shape, or place it in a custom position.</p> <p>From the drop-down list select from these options:</p> <ul style="list-style-type: none"> • Top Left • Top Center • Top Right • Left Center • Center • Right Center • Bottom Left • Bottom Center • Bottom Right • Custom <p>If you select the 'Custom' option, the element text is displayed as a label just beneath the element, and you can drag it to whatever position inside or outside the element you prefer. You can also use any of the standard label formatting facilities.</p>
Text Orientation	<p>This icon sets the orientation of the text within the element border, to either the default horizontal line ('None') or to vertical rotated clockwise or anticlockwise (the base of each letter is aligned with the left edge or the right edge, respectively).</p>
Icon Size and Position	<p>If the element has an icon (assigned by dragging an Image Asset onto the element shape), you can change the size of the icon and/or its position within the element border. Click on the toolbar icon and select:</p> <ul style="list-style-type: none"> • 'Size', and select from these options: <ul style="list-style-type: none"> - 16x16 pixels - 24x24 pixels - 32x32 pixels (the default) - Image Size (the actual size of the image in the source Image Asset; do not select this option unless the image is already small enough to act as an icon) • 'Position', and select from these options: <ul style="list-style-type: none"> - Top Left - Top Center - Top Right (the default) - Bottom Left - Bottom Center - Bottom Right
Border Style	<p>This icon enables you to change the line style of the element border. Click on the drop-down arrow and select from:</p> <ul style="list-style-type: none"> • Solid • Dashed • Dotted • Dashed-and-Dotted • None
Stack Element	<p>This icon helps you to make one element represent an abstract group of objects - people, reports, deliveries - by adding multiple frames behind the element shape. When you click on this icon, firstly select 'Stacks' and the number of edges to add,</p>

between 1 (the default) and 4.

Then select 'Direction' and one of these options:

- NW (top left corner)
- NE (top right corner; the default)
- SW (bottom left corner)
- SE (bottom right corner)

Publish Toolbar

The Publish Toolbar provides access to a number of facilities for capturing details of your model structures in a document or report for more general and external distribution.



Access

Ribbon	Explore > Portals Show Toolbar Publish
--------	--

Publish Toolbar Options

Icon	Action
Generate Documentation	Opens the 'Generate Documentation' dialog, on which you specify the parameters for generating a document on the content of the selected Package in PDF, RTF or DOCX format.
Custom Document	Prompts you to specify a name for a custom Linked Document, held in a Document Artifact element, into which you can type, paste or link any material you require on the selected Package. The Document Artifact is created as a child element of the selected Package.
Preview Mode	Displays an instant dynamic document on the selected element.
Publish As	Publish the currently-selected Package to a file in one of a number of different XML formats, for use in your preferred external tool, such as Rational Rose.
Create a New Document File	Opens a new, blank, Linked Document in the Document Editor for the selected element or Package.
Reusable Asset Service	Displays the Reusable Asset Service view through which - if you working via a connection to the Cloud - helps you to connect to your Reusable Asset Service registry and review the registry contents.
Save Diagram Image to File	If you have a diagram open this icon displays the 'Save as Image' browser, which you use to create and save a file containing an image of the diagram.
Print Diagram	Print the current diagram on the locally-defined printer.

